

**HIGH SPEED, EXTREMELY LOW NOISE LDO REGULATOR**

**AP2121**

**General Description**

The AP2121 series are positive voltage regulator ICs fabricated by CMOS process. Each of these ICs consists of a voltage reference, an error amplifier, a resistor network for setting output voltage, a current limit circuit for current protection and a chip-enable circuit (5-pin products only).

The AP2121 series feature high supply voltage ripple rejection, low dropout voltage, low noise, high output voltage accuracy, and low current consumption which make them ideal for use in various battery-powered devices.

The AP2121 series have 1.2V, 1.3V, 1.5V, 1.8V, 2.5V, 2.8V, 2.85V, 3.0V, 3.2V and 3.3V versions.

The AP2121 are available in standard SOT-23-3, SOT-23-5 and CSP-4 packages.

**Features**

- Low Dropout Voltage at  $I_{OUT}=100mA$ : 150mV Typical (Except 1.2V, 1.3V and 1.5V Versions)
- Low Standby Current: 0.1 $\mu A$  Typical
- Low Quiescent Current: 25 $\mu A$  Typical
- High Ripple Rejection: 70dB Typical ( $f=1kHz$ )
- Output Current: More Than 200mA (300mA Limit)
- Extremely Low Noise: 30 $\mu V_{rms}$  (10Hz to 100kHz)
- Excellent Line Regulation: 4mV Typical
- Excellent Load Regulation: 12mV Typical
- High Output Voltage Accuracy:  $\pm 2\%$
- Excellent Line Transient Response and Load Transient Response
- Compatible with Low ESR Ceramic Capacitor (as Low as 1 $\mu F$ )

**Applications**

- Mobile Phones, Cordless Phones
- Wireless Communication Equipment
- Portable Games
- Cameras, Video Recorders
- Sub-board Power Supplies for Telecom Equipment
- Battery Powered Equipment

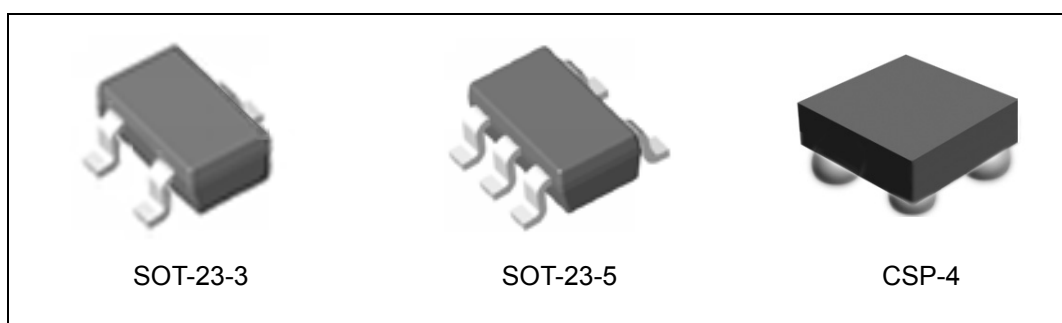

Figure 1. Package Types of AP2121

**HIGH SPEED, EXTREMELY LOW NOISE LDO REGULATOR**
**AP2121**
**Pin Configuration**

Figure 2. Pin Configuration of AP2121 (Top View)

**Pin Description**

Pin Number				Pin Name	Function
SOT-23-3	SOT-23-5	CSP-4 (J4/J4A)	CSP-4 (J4C/J4B)		
3	1	A2	A1	$V_{IN}$	Input voltage
1	2	B1	B2	GND	Ground
	3	A1	B1	CE	Active high enable input pin. Logic high=enable, logic low=shutdown
	4			NC	No connection
2	5	B2	A2	$V_{OUT}$	Regulated output voltage

**HIGH SPEED, EXTREMELY LOW NOISE LDO REGULATOR**

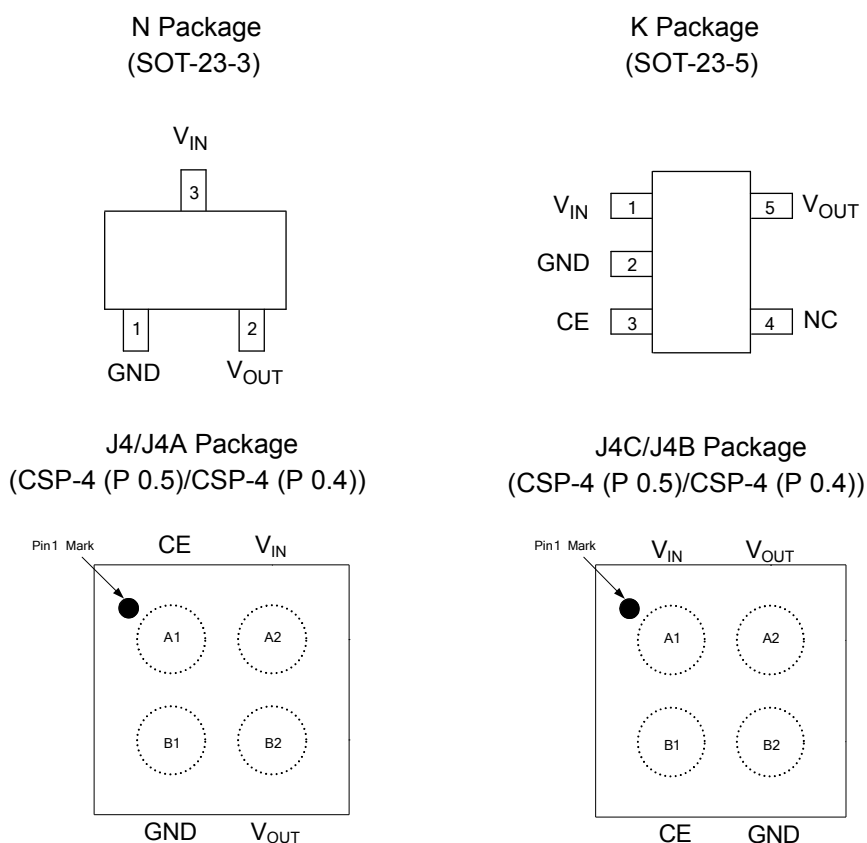
**AP2121**

**Functional Block Diagram**

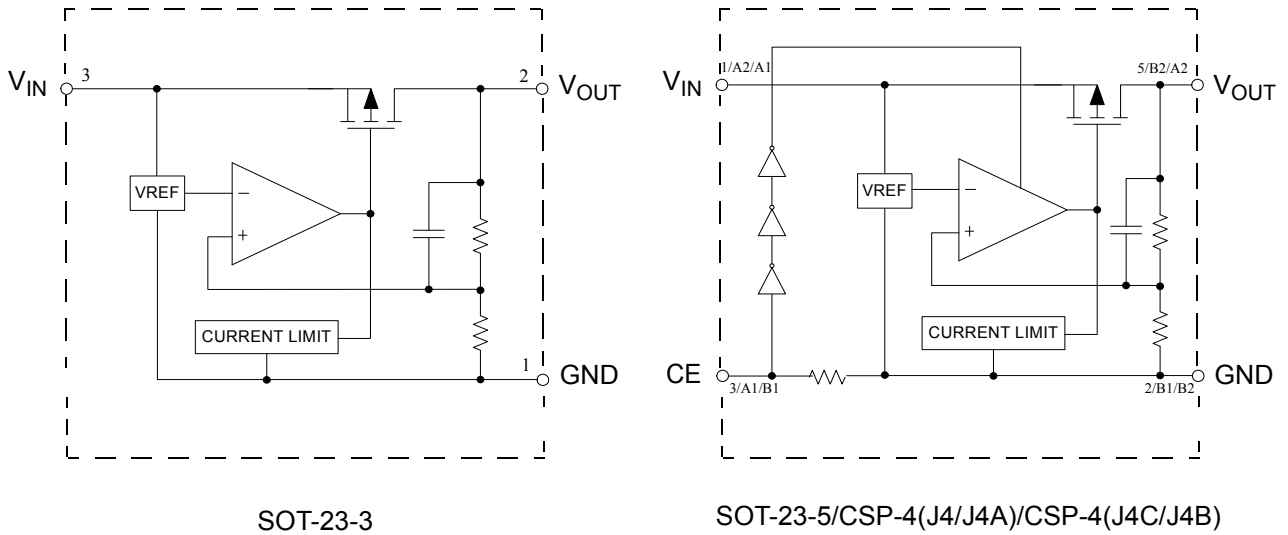
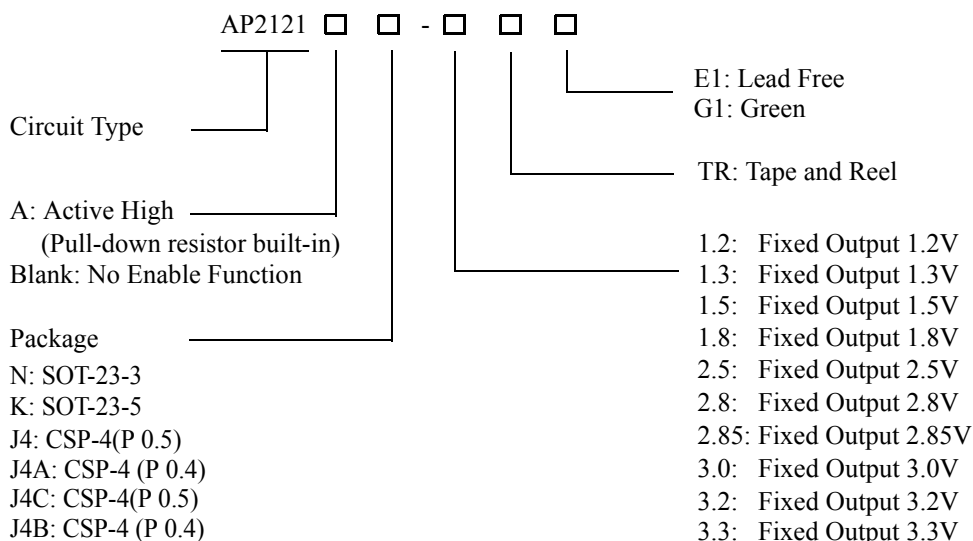

Figure 3. Functional Block Diagram of AP2121



**HIGH SPEED, EXTREMELY LOW NOISE LDO REGULATOR** **AP2121**

**Ordering Information**



Package	Temperature Range	Condition	Part Number		Marking ID		Packing Type
			Lead Free	Green	Lead Free	Green	
SOT-23-3	-40 to 85°C		AP2121N-1.2TRE1	AP2121N-1.2TRG1	EF9	GF9	Tape & Reel
			AP2121N-1.3TRE1	AP2121N-1.3TRG1	EG9	GG9	Tape & Reel
			AP2121N-1.5TRE1	AP2121N-1.5TRG1	EF1	GF1	Tape & Reel
			AP2121N-1.8TRE1	AP2121N-1.8TRG1	EF3	GF3	Tape & Reel
			AP2121N-2.5TRE1	AP2121N-2.5TRG1	EF4	GF4	Tape & Reel
			AP2121N-2.8TRE1	AP2121N-2.8TRG1	EF5	GF5	Tape & Reel
			AP2121N-3.0TRE1	AP2121N-3.0TRG1	EF6	GF6	Tape & Reel
			AP2121N-3.2TRE1	AP2121N-3.2TRG1	EF7	GF7	Tape & Reel
			AP2121N-3.3TRE1	AP2121N-3.3TRG1	EF8	GF8	Tape & Reel
SOT-23-5	-40 to 85°C	Active High (Pull-down resistor built-in)	AP2121AK-1.2TRE1	AP2121AK-1.2TRG1	E1T	G1T	Tape & Reel
		Active High (Pull-down resistor built-in)	AP2121AK-1.3TRE1	AP2121AK-1.3TRG1	E1R	G1R	Tape & Reel
		Active High (Pull-down resistor built-in)	AP2121AK-1.5TRE1	AP2121AK-1.5TRG1	E1Z	G1Z	Tape & Reel
		Active High (Pull-down resistor built-in)	AP2121AK-1.8TRE1	AP2121AK-1.8TRG1	E1U	G1U	Tape & Reel
		Active High (Pull-down resistor built-in)	AP2121AK-2.5TRE1	AP2121AK-2.5TRG1	E1V	G1V	Tape & Reel
		Active High (Pull-down resistor built-in)	AP2121AK-2.8TRE1	AP2121AK-2.8TRG1	E1W	G1W	Tape & Reel
		Active High (Pull-down resistor built-in)	AP2121AK-3.0TRE1	AP2121AK-3.0TRG1	E1X	G1X	Tape & Reel
		Active High (Pull-down resistor built-in)	AP2121AK-3.2TRE1	AP2121AK-3.2TRG1	E3Z	G3Z	Tape & Reel
		Active High (Pull-down resistor built-in)	AP2121AK-3.3TRE1	AP2121AK-3.3TRG1	E1Y	G1Y	Tape & Reel



**HIGH SPEED, EXTREMELY LOW NOISE LDO REGULATOR AP2121**

**Ordering Information (Continued)**

Package	Temperature Range	Condition	Part Number		Marking ID		Packing Type
			Lead Free	Green	Lead Free	Green	
CSP-4	-40 to 85°C	0.4 Pitch		AP2121AJ4A-1.2TRG1		CB	Tape & Reel
		0.4 Pitch		AP2121AJ4A-1.3TRG1		CC	Tape & Reel
		0.4 Pitch		AP2121AJ4A-1.5TRG1		CD	Tape & Reel
		0.4 Pitch		AP2121AJ4A-1.8TRG1		CE	Tape & Reel
		0.4 Pitch		AP2121AJ4A-2.5TRG1		CF	Tape & Reel
		0.4 Pitch		AP2121AJ4A-2.8TRG1		CG	Tape & Reel
		0.4 Pitch		AP2121AJ4A-2.85TRG1		DD	Tape & Reel
		0.4 Pitch		AP2121AJ4A-3.0TRG1		CH	Tape & Reel
		0.4 Pitch		AP2121AJ4A-3.2TRG1		DA	Tape & Reel
		0.4 Pitch		AP2121AJ4A-3.3TRG1		DB	Tape & Reel
CSP-4	-40 to 85°C	0.5 Pitch		AP2121AJ4-1.2TRG1		BA	Tape & Reel
		0.5 Pitch		AP2121AJ4-1.3TRG1		BB	Tape & Reel
		0.5 Pitch		AP2121AJ4-1.5TRG1		BC	Tape & Reel
		0.5 Pitch		AP2121AJ4-1.8TRG1		BD	Tape & Reel
		0.5 Pitch		AP2121AJ4-2.5TRG1		BE	Tape & Reel
		0.5 Pitch		AP2121AJ4-2.8TRG1		BF	Tape & Reel
		0.5 Pitch		AP2121AJ4-2.85TRG1		DC	Tape & Reel
		0.5 Pitch		AP2121AJ4-3.0TRG1		BG	Tape & Reel
		0.5 Pitch		AP2121AJ4-3.2TRG1		BH	Tape & Reel
		0.5 Pitch		AP2121AJ4-3.3TRG1		CA	Tape & Reel



**HIGH SPEED, EXTREMELY LOW NOISE LDO REGULATOR AP2121**

**Ordering Information (Continued)**

Package	Temperature Range	Condition	Part Number		Marking ID		Packing Type
			Lead Free	Green	Lead Free	Green	
CSP-4	-40 to 85°C	0.4 Pitch		AP2121AJ4B-1.2TRG1		DE	Tape & Reel
		0.4 Pitch		AP2121AJ4B-1.3TRG1		DF	Tape & Reel
		0.4 Pitch		AP2121AJ4B-1.5TRG1		DG	Tape & Reel
		0.4 Pitch		AP2121AJ4B-1.8TRG1		DH	Tape & Reel
		0.4 Pitch		AP2121AJ4B-2.5TRG1		EA	Tape & Reel
		0.4 Pitch		AP2121AJ4B-2.8TRG1		EB	Tape & Reel
		0.4 Pitch		AP2121AJ4B-2.85TRG1		EC	Tape & Reel
		0.4 Pitch		AP2121AJ4B-3.0TRG1		ED	Tape & Reel
		0.4 Pitch		AP2121AJ4B-3.2TRG1		EE	Tape & Reel
		0.4 Pitch		AP2121AJ4B-3.3TRG1		EF	Tape & Reel
CSP-4	-40 to 85°C	0.5 Pitch		AP2121AJ4C-1.2TRG1		EG	Tape & Reel
		0.5 Pitch		AP2121AJ4C-1.3TRG1		EH	Tape & Reel
		0.5 Pitch		AP2121AJ4C-1.5TRG1		FA	Tape & Reel
		0.5 Pitch		AP2121AJ4C-1.8TRG1		FB	Tape & Reel
		0.5 Pitch		AP2121AJ4C-2.5TRG1		FC	Tape & Reel
		0.5 Pitch		AP2121AJ4C-2.8TRG1		FD	Tape & Reel
		0.5 Pitch		AP2121AJ4C-2.85TRG1		FE	Tape & Reel
		0.5 Pitch		AP2121AJ4C-3.0TRG1		FF	Tape & Reel
		0.5 Pitch		AP2121AJ4C-3.2TRG1		FG	Tape & Reel
		0.5 Pitch		AP2121AJ4C-3.3TRG1		FH	Tape & Reel

BCD Semiconductor's Pb-free products, as designated with "E1" suffix in the part number, are RoHS compliant. Products with "G1" suffix are available in green packages.

**HIGH SPEED, EXTREMELY LOW NOISE LDO REGULATOR****AP2121****Absolute Maximum Ratings (Note 1)**

Parameter	Symbol	Value		Unit
Input Voltage	$V_{IN}$	6.5		V
Enable Input Voltage	$V_{CE}$	-0.3 to $V_{IN}+0.3$		V
Output Current	$I_{OUT}$	300		mA
Junction Temperature	$T_J$	150		°C
Storage Temperature Range	$T_{STG}$	-65 to 150		°C
Lead Temperature (Soldering, 10sec)	$T_{LEAD}$	260		°C
Thermal Resistance (Junction to Ambient) (Note 2)	$\theta_{JA}$	SOT-23-3	250	°C/W
		SOT-23-5	250	
		CSP-4	126	
ESD (Human Body Model)	ESD	2000		V
ESD (Machine Model)	ESD	200		V

Note 1: Stresses greater than those listed under "Absolute Maximum Ratings" may cause permanent damage to the device. These are stress ratings only, and functional operation of the device at these or any other conditions beyond those indicated under "Recommended Operating Conditions" is not implied. Exposure to "Absolute Maximum Ratings" for extended periods may affect device reliability.

Note 2: Absolute maximum ratings indicate limits beyond which damage to the component may occur. Electrical specifications do not apply when operating the device outside of its operating ratings. The maximum allowable power dissipation is a function of the maximum junction temperature,  $T_{J(max)}$ , the junction-to-ambient thermal resistance,  $\theta_{JA}$ , and the ambient temperature,  $T_A$ . The maximum allowable power dissipation at any ambient temperature is calculated using:  $P_{D(max)} = (T_{J(max)} - T_A) / \theta_{JA}$ . Exceeding the maximum allowable power dissipation will result in excessive die temperature.

**Recommended Operating Conditions**

Parameter	Symbol	Min	Max	Unit
Input Voltage	$V_{IN}$	2	6	V
Operating Ambient Temperature Range	$T_A$	-40	85	°C



**HIGH SPEED, EXTREMELY LOW NOISE LDO REGULATOR**

**AP2121**

**Electrical Characteristics**

**AP2121-1.2 Electrical Characteristics**

( $V_{IN}=2.2V$ ,  $T_J=25^{\circ}C$ ,  $C_{IN}=1\mu F$ ,  $C_{OUT}=1\mu F$ , **Bold** typeface applies over  $-40^{\circ}C \leq T_J \leq 85^{\circ}C$ , unless otherwise specified.)

Parameter	Symbol	Conditions	Min	Typ	Max	Unit
Output Voltage	$V_{OUT}$	$V_{IN}=2.2V$ $1mA \leq I_{OUT} \leq 30mA$	1.176	1.2	1.224	V
Input Voltage	$V_{IN}$				6	V
Output Current	$I_{OUT}$	$V_{IN}-V_{OUT}=1V$	200			mA
Load Regulation	$V_{RLOAD}$	$V_{IN}=2.2V$ $1mA \leq I_{OUT} \leq 80mA$		12	40	mV
Line Regulation	$V_{RLINE}$	$2.2V \leq V_{IN} \leq 6V$ $I_{OUT}=30mA$		4	16	mV
Dropout Voltage	$V_{DROP}$	$I_{OUT}=10mA$		700	900	mV
		$I_{OUT}=100mA$		700	900	
		$I_{OUT}=150mA$		700	900	
		$I_{OUT}=200mA$		700	900	
Quiescent Current	$I_Q$	$V_{IN}=2.2V$ , $I_{OUT}=0mA$		25	50	$\mu A$
Standby Current	$I_{STD}$	$V_{IN}=2.2V$ $V_{CE}$ in OFF mode		0.1	1	$\mu A$
Power Supply Rejection Ratio	PSRR	Ripple 0.5Vp-p, $f=1kHz$ $V_{IN}=2.2V$		70		dB
Output Voltage Temperature Coefficient	$\Delta V_{OUT}/\Delta T$	$I_{OUT}=30mA$		<b><math>\pm 120</math></b>		$\mu V/^{\circ}C$
	$(\Delta V_{OUT}/V_{OUT})/\Delta T$			<b><math>\pm 100</math></b>		ppm/ $^{\circ}C$
Short Current Limit	$I_{LIMIT}$	$V_{OUT}=0V$		50		mA
RMS Output Noise	$V_{NOISE}$	$T_A=25^{\circ}C$ $10Hz \leq f \leq 100kHz$		30		$\mu V_{rms}$
CE "High" Voltage		CE input voltage "High"	1.5			V
CE "Low" Voltage		CE input voltage "Low"			0.25	V
CE Pull-down Resistance	$R_{PD}$		2.5	5	10	$M\Omega$
Thermal Resistance (Junction to Case)	$\theta_{JC}$	SOT-23-3		74		$^{\circ}C/W$
		SOT-23-5		74		
		CSP-4		5		





**HIGH SPEED, EXTREMELY LOW NOISE LDO REGULATOR**

**AP2121**

**Electrical Characteristics (Continued)**

**AP2121-1.3 Electrical Characteristics**

( $V_{IN}=2.3V$ ,  $T_J=25^{\circ}C$ ,  $C_{IN}=1\mu F$ ,  $C_{OUT}=1\mu F$ , **Bold** typeface applies over  $-40^{\circ}C \leq T_J \leq 85^{\circ}C$ , unless otherwise specified.)

Parameter	Symbol	Conditions	Min	Typ	Max	Unit
Output Voltage	$V_{OUT}$	$V_{IN}=2.3V$ $1mA \leq I_{OUT} \leq 30mA$	1.274	1.3	1.326	V
Input Voltage	$V_{IN}$				6	V
Output Current	$I_{OUT}$	$V_{IN}-V_{OUT}=1V$	200			mA
Load Regulation	$V_{RLOAD}$	$V_{IN}=2.3V$ $1mA \leq I_{OUT} \leq 80mA$		12	40	mV
Line Regulation	$V_{RLINE}$	$2.3V \leq V_{IN} \leq 6V$ $I_{OUT}=30mA$		4	16	mV
Dropout Voltage	$V_{DROP}$	$I_{OUT}=10mA$		600	800	mV
		$I_{OUT}=100mA$		600	800	
		$I_{OUT}=150mA$		600	800	
		$I_{OUT}=200mA$		600	800	
Quiescent Current	$I_Q$	$V_{IN}=2.3V$ , $I_{OUT}=0mA$		25	50	$\mu A$
Standby Current	$I_{STD}$	$V_{IN}=2.3V$ $V_{CE}$ in OFF mode		0.1	1	$\mu A$
Power Supply Rejection Ratio	PSRR	Ripple 0.5Vp-p, $f=1kHz$ $V_{IN}=2.3V$		70		dB
Output Voltage Temperature Coefficient	$\Delta V_{OUT}/\Delta T$	$I_{OUT}=30mA$		<b><math>\pm 130</math></b>		$\mu V/^{\circ}C$
	$(\Delta V_{OUT}/V_{OUT})/\Delta T$			<b><math>\pm 100</math></b>		ppm/ $^{\circ}C$
Short Current Limit	$I_{LIMIT}$	$V_{OUT}=0V$		50		mA
RMS Output Noise	$V_{NOISE}$	$T_A=25^{\circ}C$ $10Hz \leq f \leq 100kHz$		30		$\mu V_{rms}$
CE "High" Voltage		CE input voltage "High"	1.5			V
CE "Low" Voltage		CE input voltage "Low"			0.25	V
CE Pull-down Resistance	$R_{PD}$		2.5	5	10	$M\Omega$
Thermal Resistance (Junction to Case)	$\theta_{JC}$	SOT-23-3		74		$^{\circ}C/W$
		SOT-23-5		74		
		CSP-4		5		



**HIGH SPEED, EXTREMELY LOW NOISE LDO REGULATOR** **AP2121**

**Electrical Characteristics (Continued)**

**AP2121-1.5 Electrical Characteristics**

( $V_{IN}=2.5V$ ,  $T_J=25^{\circ}C$ ,  $C_{IN}=1\mu F$ ,  $C_{OUT}=1\mu F$ , **Bold** typeface applies over  $-40^{\circ}C \leq T_J \leq 85^{\circ}C$ , unless otherwise specified.)

Parameter	Symbol	Conditions	Min	Typ	Max	Unit
Output Voltage	$V_{OUT}$	$V_{IN}=2.5V$ $1mA \leq I_{OUT} \leq 30mA$	1.47	1.5	1.53	V
Input Voltage	$V_{IN}$				6	V
Output Current	$I_{OUT}$	$V_{IN}-V_{OUT}=1V$	200			mA
Load Regulation	$V_{RLOAD}$	$V_{IN}=2.5V$ $1mA \leq I_{OUT} \leq 80mA$		12	40	mV
Line Regulation	$V_{RLINE}$	$2.3V \leq V_{IN} \leq 6V$ $I_{OUT}=30mA$		4	16	mV
Dropout Voltage	$V_{DROP}$	$I_{OUT}=10mA$		400	600	mV
		$I_{OUT}=100mA$		400	600	
		$I_{OUT}=150mA$		400	600	
		$I_{OUT}=200mA$		400	600	
Quiescent Current	$I_Q$	$V_{IN}=2.5V$ , $I_{OUT}=0mA$		25	50	$\mu A$
Standby Current	$I_{STD}$	$V_{IN}=2.5V$ $V_{CE}$ in OFF mode		0.1	1	$\mu A$
Power Supply Rejection Ratio	PSRR	Ripple 0.5Vp-p, $f=1kHz$ $V_{IN}=2.5V$		70		dB
Output Voltage Temperature Coefficient	$\Delta V_{OUT}/\Delta T$	$I_{OUT}=30mA$		<b><math>\pm 150</math></b>		$\mu V/^{\circ}C$
	$(\Delta V_{OUT}/V_{OUT})/\Delta T$			<b><math>\pm 100</math></b>		ppm/ $^{\circ}C$
Short Current Limit	$I_{LIMIT}$	$V_{OUT}=0V$		50		mA
RMS Output Noise	$V_{NOISE}$	$T_A=25^{\circ}C$ $10Hz \leq f \leq 100kHz$		30		$\mu V_{rms}$
CE "High" Voltage		CE input voltage "High"	1.5			V
CE "Low" Voltage		CE input voltage "Low"			0.25	V
CE Pull-down Resistance	$R_{PD}$		2.5	5	10	$M\Omega$
Thermal Resistance (Junction to Case)	$\theta_{JC}$	SOT-23-3		74		$^{\circ}C/W$
		SOT-23-5		74		
		CSP-4		5		



**HIGH SPEED, EXTREMELY LOW NOISE LDO REGULATOR** **AP2121**

**Electrical Characteristics (Continued)**

**AP2121-1.8 Electrical Characteristics**

( $V_{IN}=2.8V$ ,  $T_J=25^{\circ}C$ ,  $C_{IN}=1\mu F$ ,  $C_{OUT}=1\mu F$ , **Bold** typeface applies over  $-40^{\circ}C \leq T_J \leq 85^{\circ}C$ , unless otherwise specified.)

Parameter	Symbol	Conditions	Min	Typ	Max	Unit
Output Voltage	$V_{OUT}$	$V_{IN}=2.8V$ $1mA \leq I_{OUT} \leq 30mA$	1.764	1.8	1.836	V
Input Voltage	$V_{IN}$				6	V
Output Current	$I_{OUT}$	$V_{IN}-V_{OUT}=1V$	200			mA
Load Regulation	$V_{RLOAD}$	$V_{IN}=2.8V$ $1mA \leq I_{OUT} \leq 80mA$		12	40	mV
Line Regulation	$V_{RLINE}$	$2.3V \leq V_{IN} \leq 6V$ $I_{OUT}=30mA$		4	16	mV
Dropout Voltage	$V_{DROP}$	$I_{OUT}=10mA$		20	40	mV
		$I_{OUT}=100mA$		150	300	
		$I_{OUT}=150mA$		200	400	
		$I_{OUT}=200mA$		250	500	
Quiescent Current	$I_Q$	$V_{IN}=2.8V$ , $I_{OUT}=0mA$		25	50	$\mu A$
Standby Current	$I_{STD}$	$V_{IN}=2.8V$ $V_{CE}$ in OFF mode		0.1	1	$\mu A$
Power Supply Rejection Ratio	PSRR	Ripple 0.5Vp-p, $f=1kHz$ $V_{IN}=2.8V$		70		dB
Output Voltage Temperature Coefficient	$\Delta V_{OUT}/\Delta T$	$I_{OUT}=30mA$		$\pm 180$		$\mu V/^{\circ}C$
	$(\Delta V_{OUT}/V_{OUT})/\Delta T$			$\pm 100$		ppm/ $^{\circ}C$
Short Current Limit	$I_{LIMIT}$	$V_{OUT}=0V$		50		mA
RMS Output Noise	$V_{NOISE}$	$T_A=25^{\circ}C$ $10Hz \leq f \leq 100kHz$		30		$\mu V_{rms}$
CE "High" Voltage		CE input voltage "High"	1.5			V
CE "Low" Voltage		CE input voltage "Low"			0.25	V
CE Pull-down Resistance	$R_{PD}$		2.5	5	10	$M\Omega$
Thermal Resistance (Junction to Case)	$\theta_{JC}$	SOT-23-3		74		$^{\circ}C/W$
		SOT-23-5		74		
		CSP-4		5		



**HIGH SPEED, EXTREMELY LOW NOISE LDO REGULATOR** **AP2121**

**Electrical Characteristics (Continued)**

**AP2121-2.5 Electrical Characteristics**

( $V_{IN}=3.5V$ ,  $T_J=25^{\circ}C$ ,  $C_{IN}=1\mu F$ ,  $C_{OUT}=1\mu F$ , **Bold** typeface applies over  $-40^{\circ}C \leq T_J \leq 85^{\circ}C$ , unless otherwise specified.)

Parameter	Symbol	Conditions	Min	Typ	Max	Unit
Output Voltage	$V_{OUT}$	$V_{IN}=3.5V$ $1mA \leq I_{OUT} \leq 30mA$	2.45	2.5	2.55	V
Input Voltage	$V_{IN}$				6	V
Output Current	$I_{OUT}$	$V_{IN}-V_{OUT}=1V$	200			mA
Load Regulation	$V_{RLOAD}$	$V_{IN}=3.5V$ $1mA \leq I_{OUT} \leq 80mA$		12	40	mV
Line Regulation	$V_{RLINE}$	$3V \leq V_{IN} \leq 6V$ $I_{OUT}=30mA$		4	16	mV
Dropout Voltage	$V_{DROP}$	$I_{OUT}=10mA$		20	40	mV
		$I_{OUT}=100mA$		150	300	
		$I_{OUT}=150mA$		200	400	
		$I_{OUT}=200mA$		250	500	
Quiescent Current	$I_Q$	$V_{IN}=3.5V$ , $I_{OUT}=0mA$		25	50	$\mu A$
Standby Current	$I_{STD}$	$V_{IN}=3.5V$ $V_{CE}$ in OFF mode		0.1	1	$\mu A$
Power Supply Rejection Ratio	PSRR	Ripple 0.5Vp-p, $f=1kHz$ $V_{IN}=3.5V$		70		dB
Output Voltage Temperature Coefficient	$\Delta V_{OUT}/\Delta T$	$I_{OUT}=30mA$		<b><math>\pm 250</math></b>		$\mu V/^{\circ}C$
	$(\Delta V_{OUT}/V_{OUT})/\Delta T$			<b><math>\pm 100</math></b>		ppm/ $^{\circ}C$
Short Current Limit	$I_{LIMIT}$	$V_{OUT}=0V$		50		mA
RMS Output Noise	$V_{NOISE}$	$T_A=25^{\circ}C$ $10Hz \leq f \leq 100kHz$		30		$\mu V_{rms}$
CE "High" Voltage		CE input voltage "High"	1.5			V
CE "Low" Voltage		CE input voltage "Low"			0.25	V
CE Pull-down Resistance	$R_{PD}$		2.5	5	10	$M\Omega$
Thermal Resistance (Junction to Case)	$\theta_{JC}$	SOT-23-3		74		$^{\circ}C/W$
		SOT-23-5		74		
		CSP-4		5		



**HIGH SPEED, EXTREMELY LOW NOISE LDO REGULATOR**

**AP2121**

**Electrical Characteristics (Continued)**

**AP2121-2.8 Electrical Characteristics**

( $V_{IN}=3.8V$ ,  $T_J=25^{\circ}C$ ,  $C_{IN}=1\mu F$ ,  $C_{OUT}=1\mu F$ , **Bold** typeface applies over  $-40^{\circ}C \leq T_J \leq 85^{\circ}C$ , unless otherwise specified.)

Parameter	Symbol	Conditions	Min	Typ	Max	Unit
Output Voltage	$V_{OUT}$	$V_{IN}=3.8V$ $1mA \leq I_{OUT} \leq 30mA$	2.744	2.8	2.856	V
Input Voltage	$V_{IN}$				6	V
Output Current	$I_{OUT}$	$V_{IN}-V_{OUT}=1V$	200			mA
Load Regulation	$V_{RLOAD}$	$V_{IN}=3.8V$ $1mA \leq I_{OUT} \leq 80mA$		12	40	mV
Line Regulation	$V_{RLINE}$	$3.3V \leq V_{IN} \leq 6V$ $I_{OUT}=30mA$		4	16	mV
Dropout Voltage	$V_{DROP}$	$I_{OUT}=10mA$		20	40	mV
		$I_{OUT}=100mA$		150	300	
		$I_{OUT}=150mA$		200	400	
		$I_{OUT}=200mA$		250	500	
Quiescent Current	$I_Q$	$V_{IN}=3.8V$ , $I_{OUT}=0mA$		25	50	$\mu A$
Standby Current	$I_{STD}$	$V_{IN}=3.8V$ $V_{CE}$ in OFF mode		0.1	1	$\mu A$
Power Supply Rejection Ratio	PSRR	Ripple 0.5Vp-p, $f=1kHz$ $V_{IN}=3.8V$		70		dB
Output Voltage Temperature Coefficient	$\Delta V_{OUT}/\Delta T$	$I_{OUT}=30mA$		<b><math>\pm 280</math></b>		$\mu V/^{\circ}C$
	$(\Delta V_{OUT}/V_{OUT})/\Delta T$			<b><math>\pm 100</math></b>		ppm/ $^{\circ}C$
Short Current Limit	$I_{LIMIT}$	$V_{OUT}=0V$		50		mA
RMS Output Noise	$V_{NOISE}$	$T_A=25^{\circ}C$ $10Hz \leq f \leq 100kHz$		30		$\mu V_{rms}$
CE "High" Voltage		CE input voltage "High"	1.5			V
CE "Low" Voltage		CE input voltage "Low"			0.25	V
CE Pull-down Resistance	$R_{PD}$		2.5	5	10	$M\Omega$
Thermal Resistance (Junction to Case)	$\theta_{JC}$	SOT-23-3		74		$^{\circ}C/W$
		SOT-23-5		74		
		CSP-4		5		



**HIGH SPEED, EXTREMELY LOW NOISE LDO REGULATOR**

**AP2121**

**Electrical Characteristics (Continued)**

**AP2121-2.85 Electrical Characteristics**

( $V_{IN}=3.85V$ ,  $T_J=25^{\circ}C$ ,  $C_{IN}=1\mu F$ ,  $C_{OUT}=1\mu F$ , **Bold** typeface applies over  $-40^{\circ}C \leq T_J \leq 85^{\circ}C$ , unless otherwise specified.)

Parameter	Symbol	Conditions	Min	Typ	Max	Unit
Output Voltage	$V_{OUT}$	$V_{IN}=3.85V$ $1mA \leq I_{OUT} \leq 30mA$	2.793	2.85	2.907	V
Input Voltage	$V_{IN}$				6	V
Output Current	$I_{OUT}$	$V_{IN}-V_{OUT}=1V$	200			mA
Load Regulation	$V_{RLOAD}$	$V_{IN}=3.85V$ $1mA \leq I_{OUT} \leq 80mA$		12	40	mV
Line Regulation	$V_{RLINE}$	$3.3V \leq V_{IN} \leq 6V$ $I_{OUT}=30mA$		4	16	mV
Dropout Voltage	$V_{DROP}$	$I_{OUT}=10mA$		20	40	mV
		$I_{OUT}=100mA$		150	300	
		$I_{OUT}=150mA$		200	400	
		$I_{OUT}=200mA$		250	500	
Quiescent Current	$I_Q$	$V_{IN}=3.85V$ , $I_{OUT}=0mA$		25	50	$\mu A$
Standby Current	$I_{STD}$	$V_{IN}=3.85V$ $V_{CE}$ in OFF mode		0.1	1	$\mu A$
Power Supply Rejection Ratio	PSRR	Ripple 0.5Vp-p, $f=1kHz$ $V_{IN}=3.85V$		70		dB
Output Voltage Temperature Coefficient	$\Delta V_{OUT}/\Delta T$	$I_{OUT}=30mA$		<b><math>\pm 280</math></b>		$\mu V/^{\circ}C$
	$(\Delta V_{OUT}/V_{OUT})/\Delta T$			<b><math>\pm 100</math></b>		ppm/ $^{\circ}C$
Short Current Limit	$I_{LIMIT}$	$V_{OUT}=0V$		50		mA
RMS Output Noise	$V_{NOISE}$	$T_A=25^{\circ}C$ $10Hz \leq f \leq 100kHz$		30		$\mu V_{rms}$
CE "High" Voltage		CE input voltage "High"	1.5			V
CE "Low" Voltage		CE input voltage "Low"			0.25	V
CE Pull-down Resistance	$R_{PD}$		2.5	5	10	$M\Omega$
Thermal Resistance (Junction to Case)	$\theta_{JC}$	CSP-4		5		$^{\circ}C/W$



**HIGH SPEED, EXTREMELY LOW NOISE LDO REGULATOR**

**AP2121**

**Electrical Characteristics (Continued)**

**AP2121-3.0 Electrical Characteristics**

( $V_{IN}=4V$ ,  $T_J=25^{\circ}C$ ,  $C_{IN}=1\mu F$ ,  $C_{OUT}=1\mu F$ , **Bold** typeface applies over  $-40^{\circ}C \leq T_J \leq 85^{\circ}C$ , unless otherwise specified.)

Parameter	Symbol	Conditions	Min	Typ	Max	Unit
Output Voltage	$V_{OUT}$	$V_{IN}=4V$ $1mA \leq I_{OUT} \leq 30mA$	2.94	3.0	3.06	V
Input Voltage	$V_{IN}$				6	V
Output Current	$I_{OUT}$	$V_{IN}-V_{OUT}=1V$	200			mA
Load Regulation	$V_{RLOAD}$	$V_{IN}=4V$ $1mA \leq I_{OUT} \leq 80mA$		12	40	mV
Line Regulation	$V_{RLINE}$	$3.5V \leq V_{IN} \leq 6V$ $I_{OUT}=30mA$		4	16	mV
Dropout Voltage	$V_{DROP}$	$I_{OUT}=10mA$		20	40	mV
		$I_{OUT}=100mA$		150	300	
		$I_{OUT}=150mA$		200	400	
		$I_{OUT}=200mA$		250	500	
Quiescent Current	$I_Q$	$V_{IN}=4V$ , $I_{OUT}=0mA$		25	50	$\mu A$
Standby Current	$I_{STD}$	$V_{IN}=4V$ $V_{CE}$ in OFF mode		0.1	1	$\mu A$
Power Supply Rejection Ratio	PSRR	Ripple 0.5Vp-p, $f=1kHz$ $V_{IN}=4V$		70		dB
Output Voltage Temperature Coefficient	$\Delta V_{OUT}/\Delta T$	$I_{OUT}=30mA$		<b><math>\pm 300</math></b>		$\mu V/^{\circ}C$
	$(\Delta V_{OUT}/V_{OUT})/\Delta T$			<b><math>\pm 100</math></b>		ppm/ $^{\circ}C$
Short Current Limit	$I_{LIMIT}$	$V_{OUT}=0V$		50		mA
RMS Output Noise	$V_{NOISE}$	$T_A=25^{\circ}C$ $10Hz \leq f \leq 100kHz$		30		$\mu V_{rms}$
CE "High" Voltage		CE input voltage "High"	1.5			V
CE "Low" Voltage		CE input voltage "Low"			0.25	V
CE Pull-down Resistance	$R_{PD}$		2.5	5	10	$M\Omega$
Thermal Resistance (Junction to Case)	$\theta_{JC}$	SOT-23-3		74		$^{\circ}C/W$
		SOT-23-5		74		
		CSP-4		5		



**HIGH SPEED, EXTREMELY LOW NOISE LDO REGULATOR** **AP2121**

**Electrical Characteristics (Continued)**

**AP2121-3.2 Electrical Characteristics**

( $V_{IN}=4.2V$ ,  $T_J=25^{\circ}C$ ,  $C_{IN}=1\mu F$ ,  $C_{OUT}=1\mu F$ , **Bold** typeface applies over  $-40^{\circ}C \leq T_J \leq 85^{\circ}C$ , unless otherwise specified.)

Parameter	Symbol	Conditions	Min	Typ	Max	Unit
Output Voltage	$V_{OUT}$	$V_{IN}=4.2V$ $1mA \leq I_{OUT} \leq 30mA$	3.136	3.2	3.264	V
Input Voltage	$V_{IN}$				6	V
Output Current	$I_{OUT}$	$V_{IN}-V_{OUT}=1V$	200			mA
Load Regulation	$V_{RLOAD}$	$V_{IN}=4.2V$ $1mA \leq I_{OUT} \leq 80mA$		12	40	mV
Line Regulation	$V_{RLINE}$	$3.7V \leq V_{IN} \leq 6V$ $I_{OUT}=30mA$		4	16	mV
Dropout Voltage	$V_{DROP}$	$I_{OUT}=10mA$		20	40	mV
		$I_{OUT}=100mA$		150	300	
		$I_{OUT}=150mA$		200	400	
		$I_{OUT}=200mA$		250	500	
Quiescent Current	$I_Q$	$V_{IN}=4.2V$ , $I_{OUT}=0mA$		25	50	$\mu A$
Standby Current	$I_{STD}$	$V_{IN}=4.2V$ $V_{CE}$ in OFF mode		0.1	1	$\mu A$
Power Supply Rejection Ratio	PSRR	Ripple 0.5Vp-p, $f=1kHz$ $V_{IN}=4.2V$		70		dB
Output Voltage Temperature Coefficient	$\Delta V_{OUT}/\Delta T$	$I_{OUT}=30mA$		<b><math>\pm 320</math></b>		$\mu V/^{\circ}C$
	$(\Delta V_{OUT}/V_{OUT})/\Delta T$			<b><math>\pm 100</math></b>		ppm/ $^{\circ}C$
Short Current Limit	$I_{LIMIT}$	$V_{OUT}=0V$		50		mA
RMS Output Noise	$V_{NOISE}$	$T_A=25^{\circ}C$ $10Hz \leq f \leq 100kHz$		30		$\mu V_{rms}$
CE "High" Voltage		CE input voltage "High"	1.5			V
CE "Low" Voltage		CE input voltage "Low"			0.25	V
CE Pull-down Resistance	$R_{PD}$		2.5	5	10	M $\Omega$
Thermal Resistance (Junction to Case)	$\theta_{JC}$	SOT-23-3		74		$^{\circ}C/W$
		SOT-23-5		74		
		CSP-4		5		





**HIGH SPEED, EXTREMELY LOW NOISE LDO REGULATOR** **AP2121**

**Electrical Characteristics (Continued)**

**AP2121-3.3 Electrical Characteristics**

( $V_{IN}=4.3V$ ,  $T_J=25^{\circ}C$ ,  $C_{IN}=1\mu F$ ,  $C_{OUT}=1\mu F$ , **Bold** typeface applies over  $-40^{\circ}C \leq T_J \leq 85^{\circ}C$ , unless otherwise specified.)

Parameter	Symbol	Conditions	Min	Typ	Max	Unit
Output Voltage	$V_{OUT}$	$V_{IN}=4.3V$ $1mA \leq I_{OUT} \leq 30mA$	3.234	3.3	3.366	V
Input Voltage	$V_{IN}$				6	V
Output Current	$I_{OUT}$	$V_{IN}-V_{OUT}=1V$	200			mA
Load Regulation	$V_{RLOAD}$	$V_{IN}=4.3V$ $1mA \leq I_{OUT} \leq 80mA$		12	40	mV
Line Regulation	$V_{RLINE}$	$3.8V \leq V_{IN} \leq 6V$ $I_{OUT}=30mA$		4	16	mV
Dropout Voltage	$V_{DROP}$	$I_{OUT}=10mA$		20	40	mV
		$I_{OUT}=100mA$		150	300	
		$I_{OUT}=150mA$		200	400	
		$I_{OUT}=200mA$		250	500	
Quiescent Current	$I_Q$	$V_{IN}=4.3V$ , $I_{OUT}=0mA$		25	50	$\mu A$
Standby Current	$I_{STD}$	$V_{IN}=4.3V$ $V_{CE}$ in OFF mode		0.1	1	$\mu A$
Power Supply Rejection Ratio	PSRR	Ripple 0.5Vp-p, $f=1kHz$ $V_{IN}=4.3V$		70		dB
Output Voltage Temperature Coefficient	$\Delta V_{OUT}/\Delta T$	$I_{OUT}=30mA$		<b><math>\pm 330</math></b>		$\mu V/^{\circ}C$
	$(\Delta V_{OUT}/V_{OUT})/\Delta T$			<b><math>\pm 100</math></b>		ppm/ $^{\circ}C$
Short Current Limit	$I_{LIMIT}$	$V_{OUT}=0V$		50		mA
RMS Output Noise	$V_{NOISE}$	$T_A=25^{\circ}C$ $10Hz \leq f \leq 100kHz$		30		$\mu V_{rms}$
CE "High" Voltage		CE input voltage "High"	1.5			V
CE "Low" Voltage		CE input voltage "Low"			0.25	V
CE Pull-down Resistance	$R_{PD}$		2.5	5	10	M $\Omega$
Thermal Resistance (Junction to Case)	$\theta_{JC}$	SOT-23-3		74		$^{\circ}C/W$
		SOT-23-5		74		
		CSP-4		5		



**Typical Performance Characteristics**

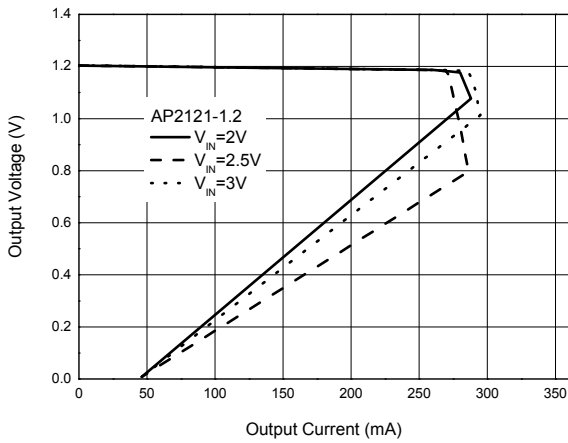

Figure 4. Output Voltage vs. Output Current

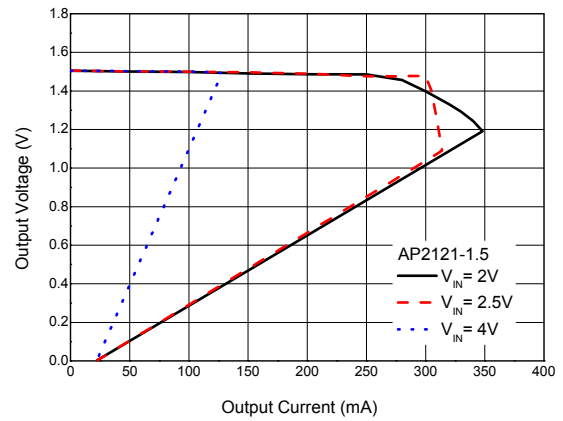

Figure 5. Output Voltage vs. Output Current

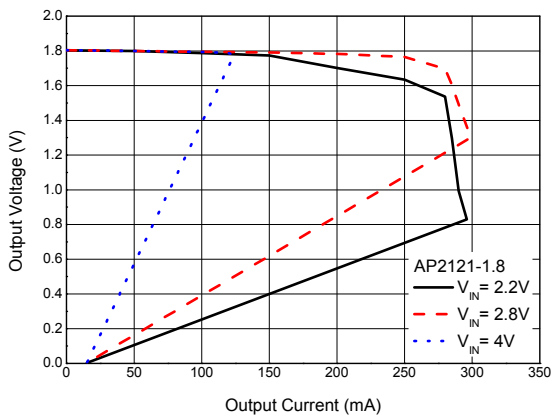

Figure 6. Output Voltage vs. Output Current

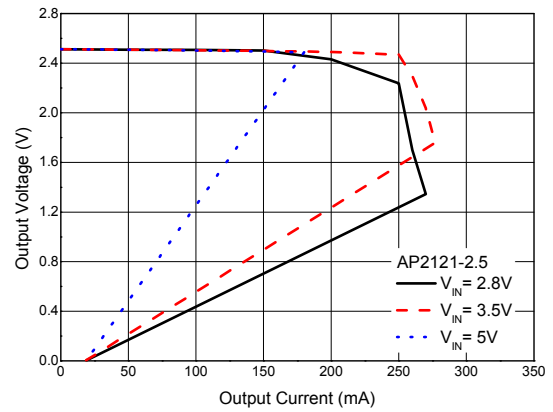

Figure 7. Output Voltage vs. Output Current



**HIGH SPEED, EXTREMELY LOW NOISE LDO REGULATOR**

**AP2121**

**Typical Performance Characteristics (Continued)**

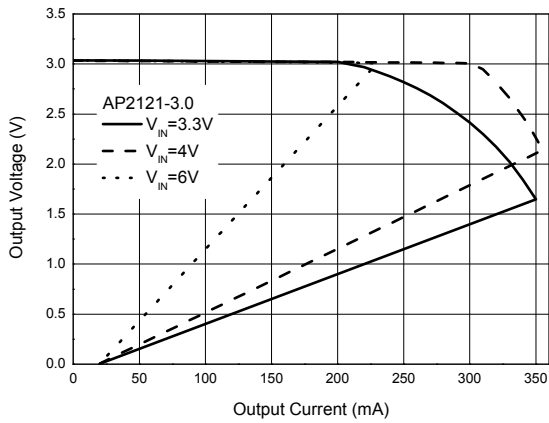

Figure 8. Output Voltage vs. Output Current

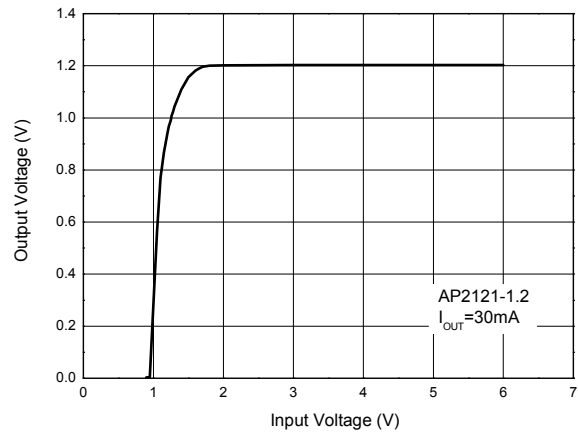

Figure 9. Output Voltage vs. Input Voltage

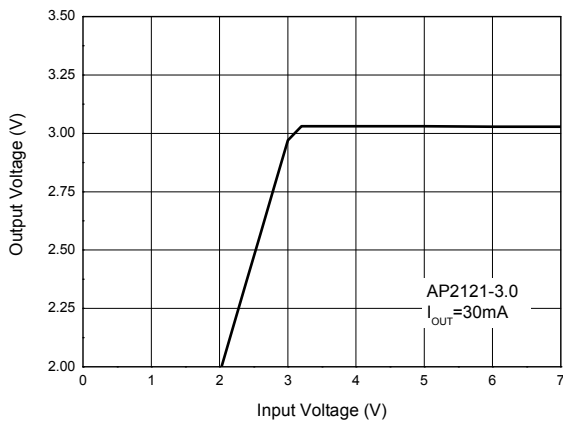

Figure 10. Output Voltage vs. Input Voltage

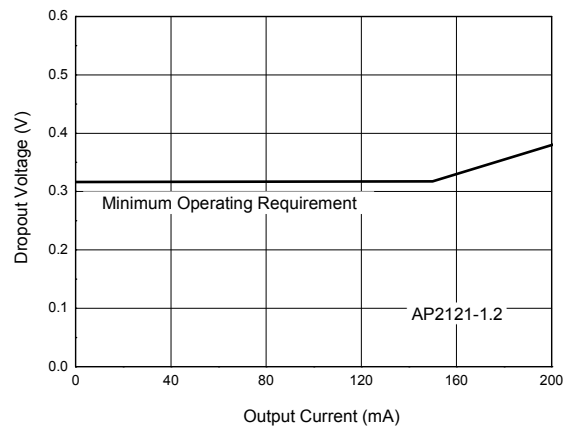

Figure 11. Dropout Voltage vs. Output Current



**HIGH SPEED, EXTREMELY LOW NOISE LDO REGULATOR**

**AP2121**

**Typical Performance Characteristics (Continued)**

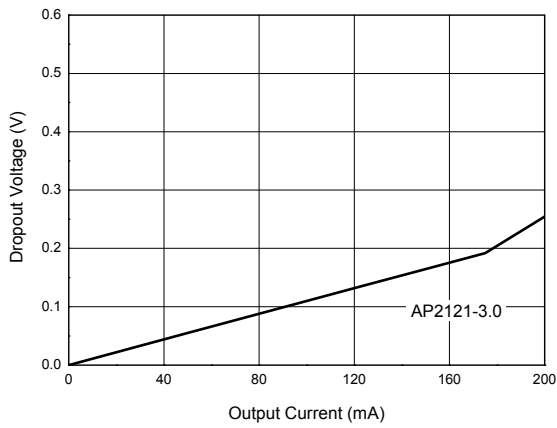

Figure 12. Dropout Voltage vs. Output Current

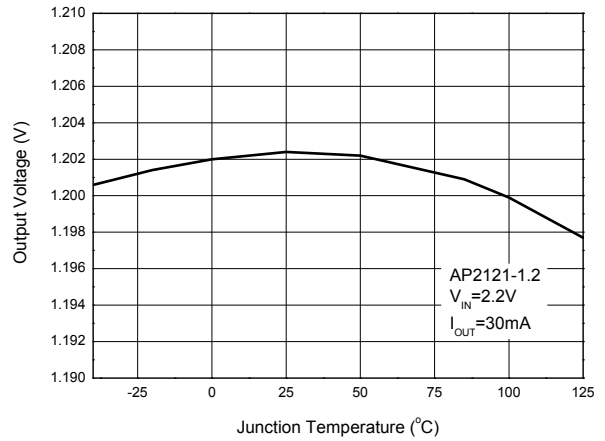

Figure 13. Output Voltage vs. Junction Temperature

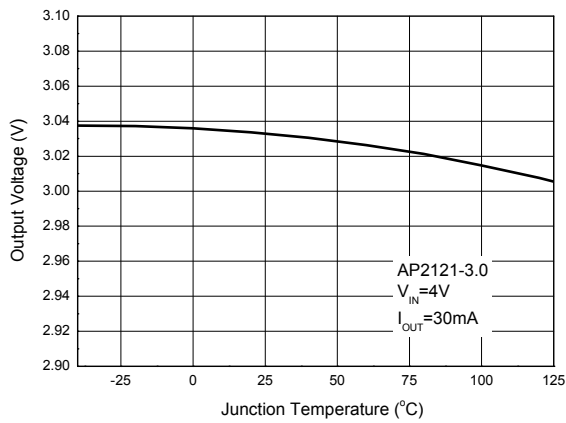

Figure 14. Output Voltage vs. Junction Temperature

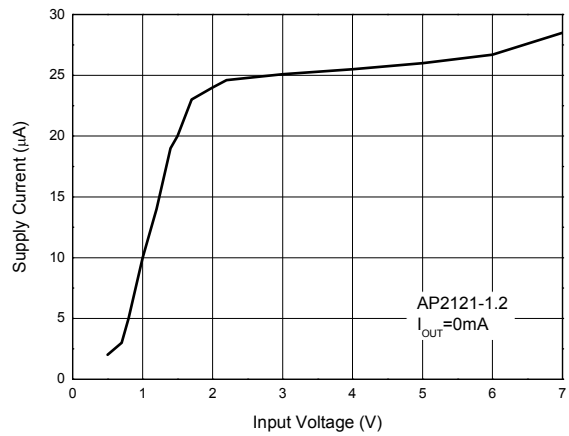

Figure 15. Supply Current vs. Input Voltage



**HIGH SPEED, EXTREMELY LOW NOISE LDO REGULATOR**

**AP2121**

**Typical Performance Characteristics (Continued)**

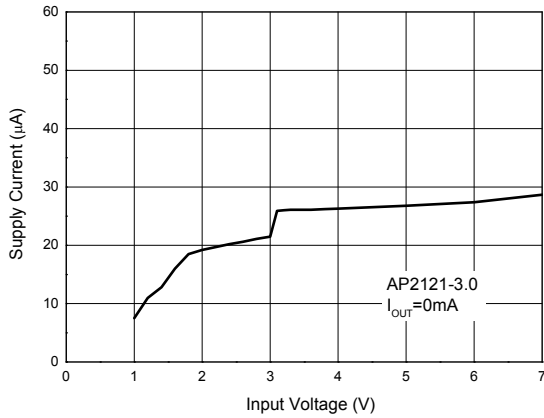

Figure 16. Supply Current vs. Input Voltage

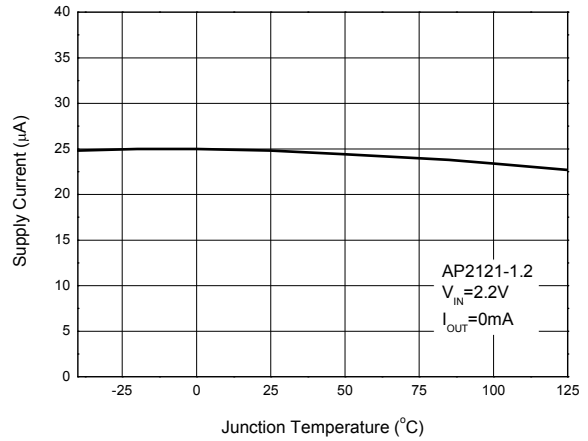

Figure 17. Supply Current vs. Junction Temperature

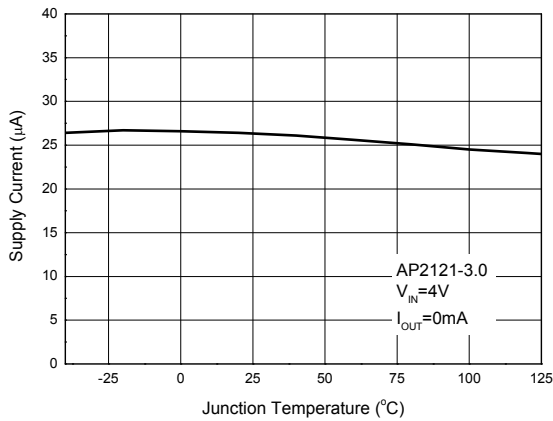

Figure 18. Supply Current vs. Junction Temperature

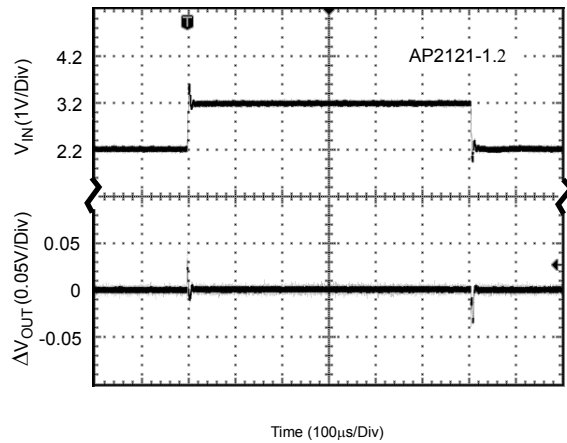

Figure 19. Line Transient  
(Conditions:  $I_{\text{OUT}}=30\text{mA}$ ,  $C_{\text{IN}}=1\mu\text{F}$ ,  $C_{\text{OUT}}=1\mu\text{F}$ )

**Typical Performance Characteristics (Continued)**

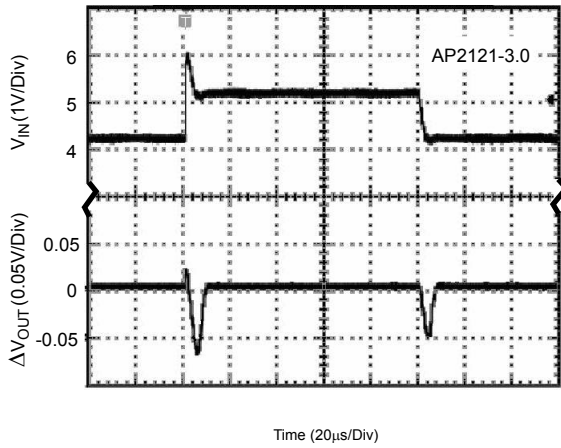

Figure 20. Line Transient  
(Conditions:  $I_{OUT}=30\text{mA}$ ,  $C_{IN}=1\mu\text{F}$ ,  $C_{OUT}=1\mu\text{F}$ )

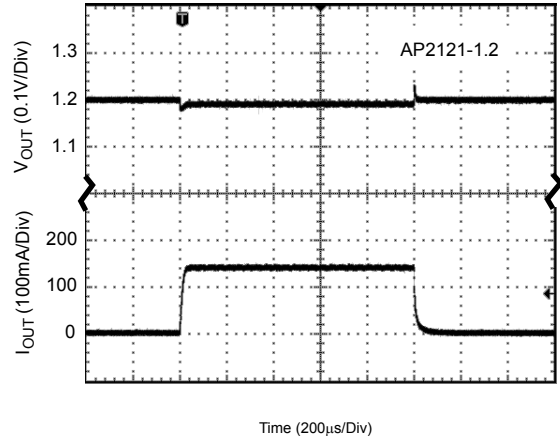

Figure 21. Load Transient  
(Conditions:  $V_{IN}=2.2\text{V}$ ,  $C_{IN}=1\mu\text{F}$ ,  $C_{OUT}=1\mu\text{F}$ )

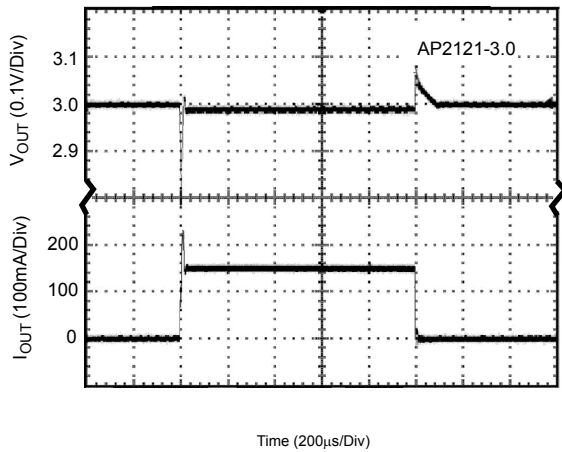

Figure 22. Load Transient  
(Conditions:  $V_{IN}=4\text{V}$ ,  $C_{IN}=1\mu\text{F}$ ,  $C_{OUT}=1\mu\text{F}$ )

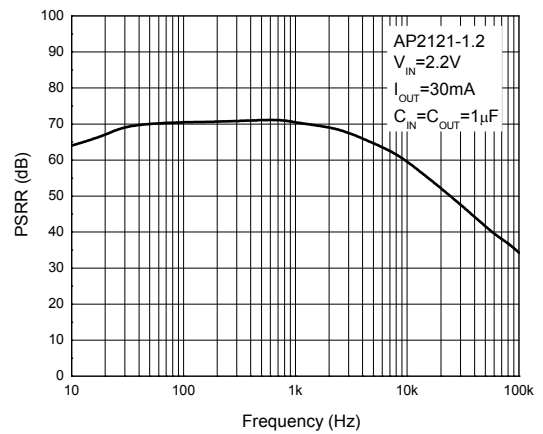

Figure 23. PSRR vs. Frequency



**Typical Performance Characteristics (Continued)**

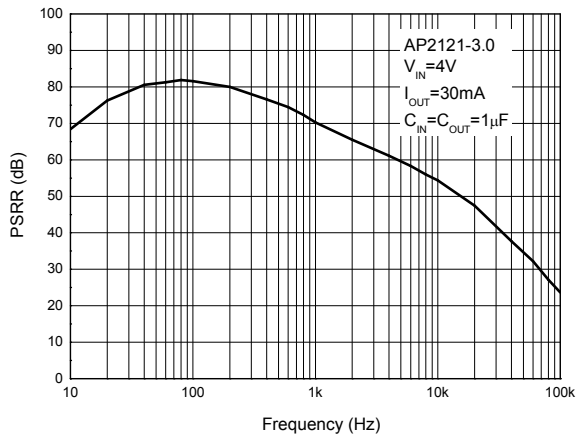
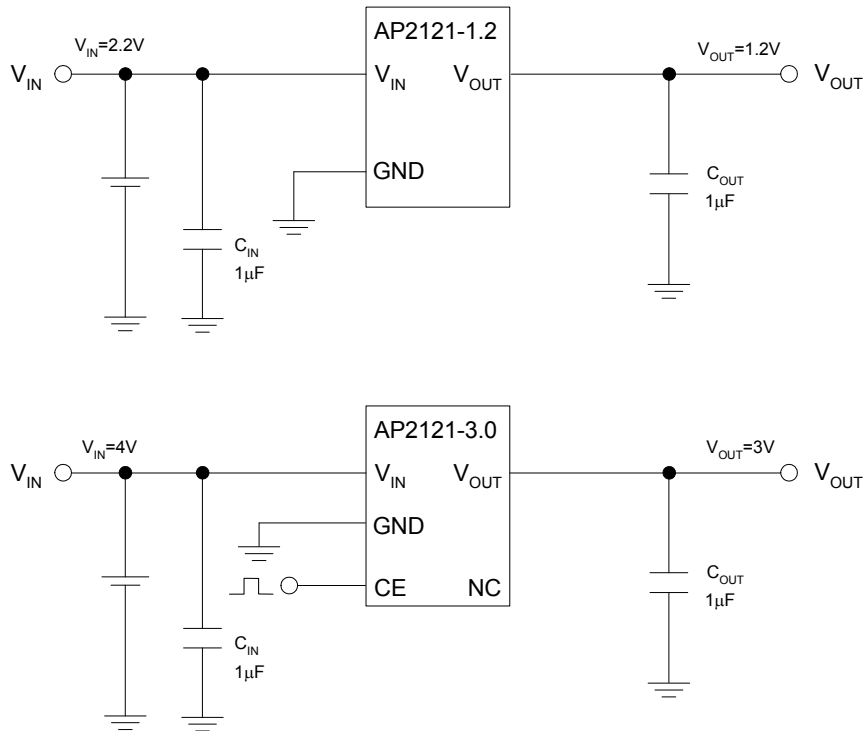

Figure 24. PSRR vs. Frequency

**Typical Application**

Note: Filter capacitors are required at the AP2121's input and output.  $1\mu F$  capacitor is required at the input. The minimum output capacitance required for stability should be more than  $1\mu F$  with ESR from  $0.01\Omega$  to  $100\Omega$ . Ceramic capacitors are recommended.

Figure 25. Typical Application of AP2121





**HIGH SPEED, EXTREMELY LOW NOISE LDO REGULATOR**

**AP2121**

**Mechanical Dimensions**

**SOT-23-3**

**Unit: mm(inch)**

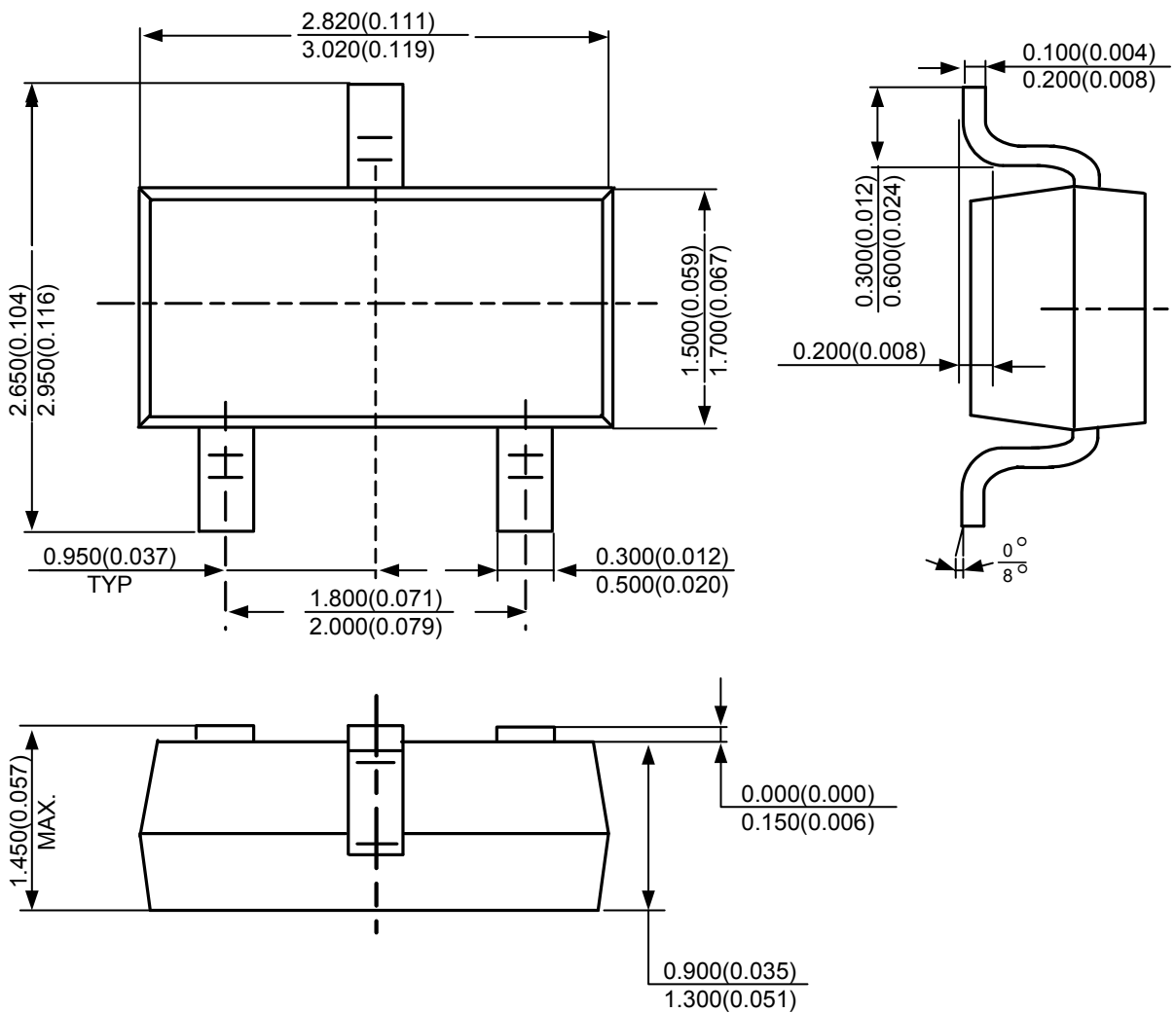



**HIGH SPEED, EXTREMELY LOW NOISE LDO REGULATOR**

**AP2121**

**Mechanical Dimensions (Continued)**

**SOT-23-5**

**Unit: mm(inch)**

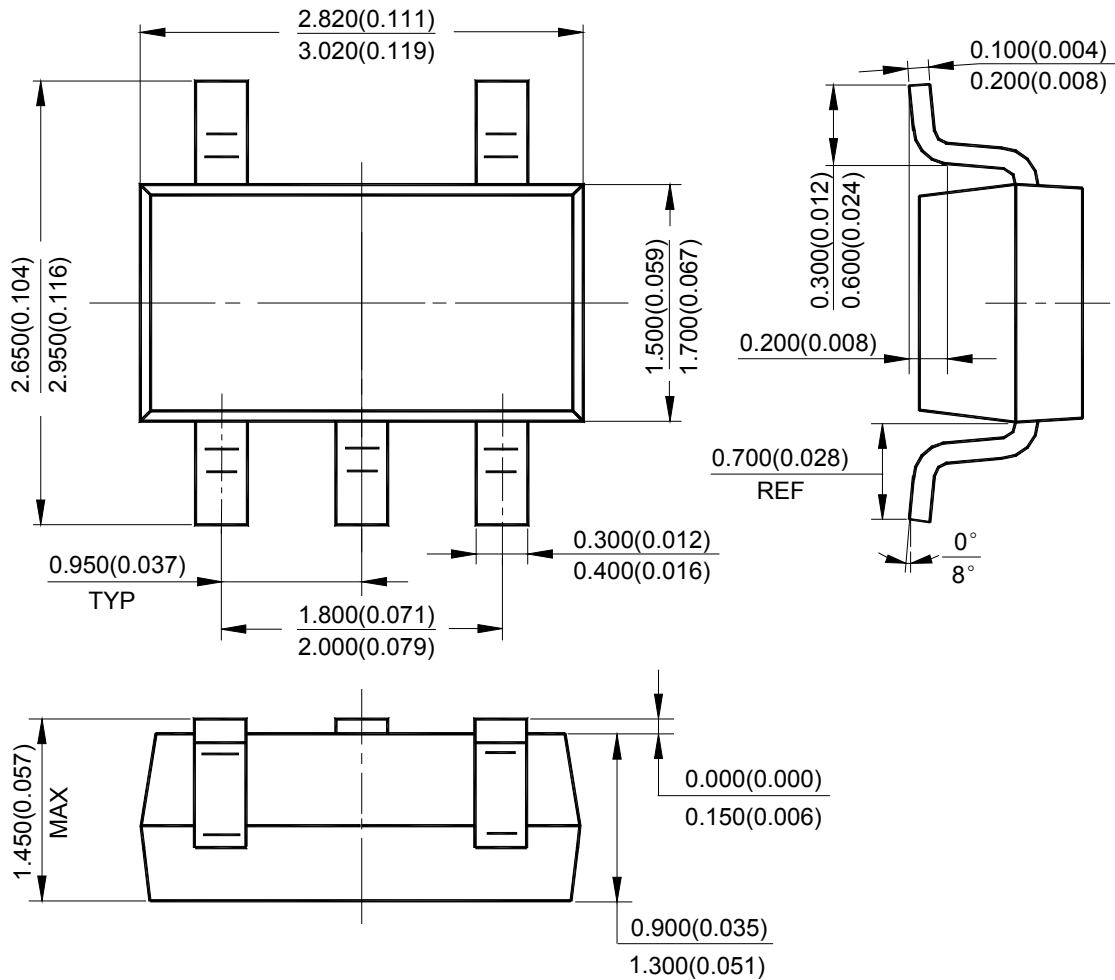



**Mechanical Dimensions (Continued)**

**CSP-4 (P 0.4)**

**Unit: mm(inch)**

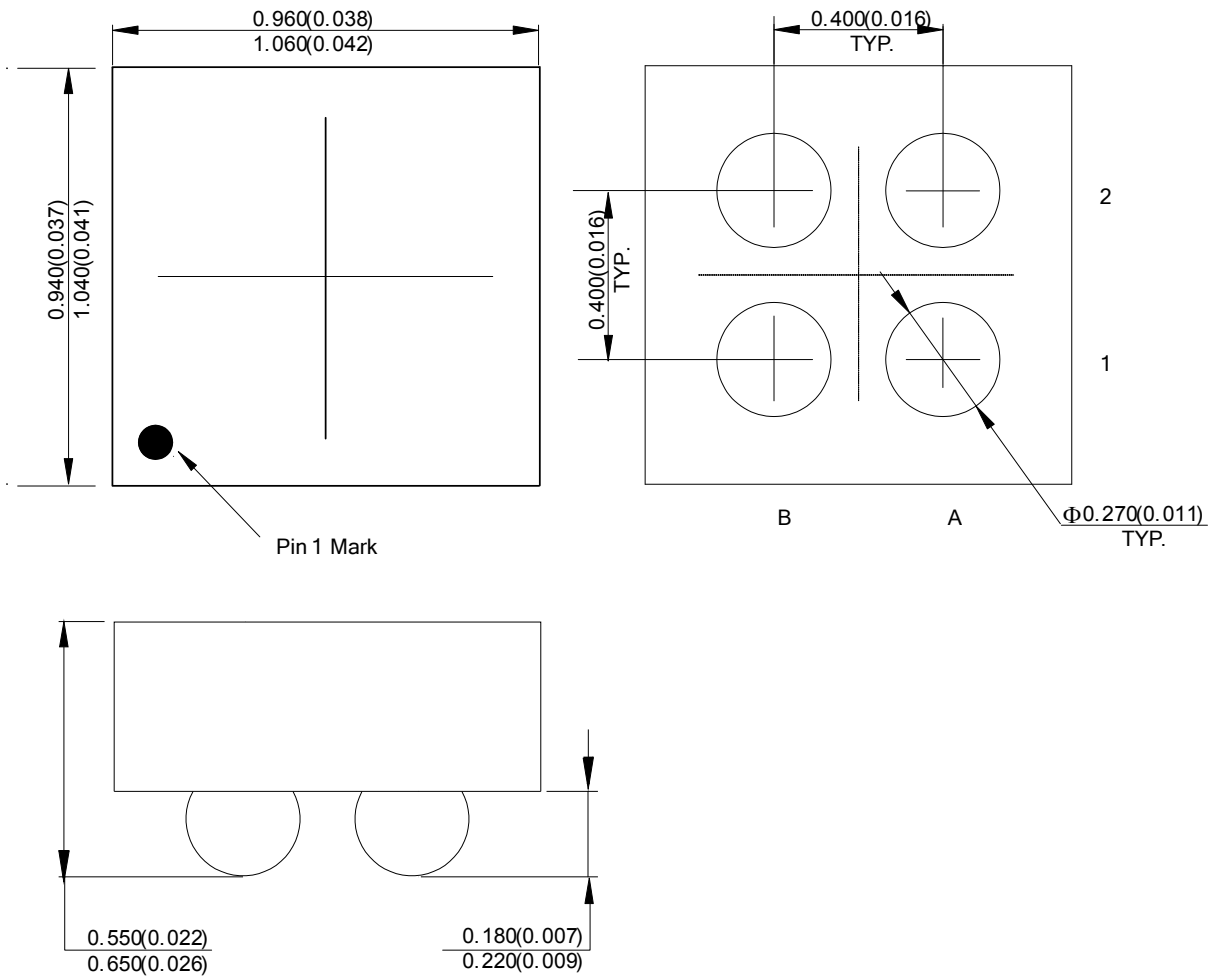



**Mechanical Dimensions (Continued)**

**CSP-4 (P 0.5)**

**Unit: mm(inch)**

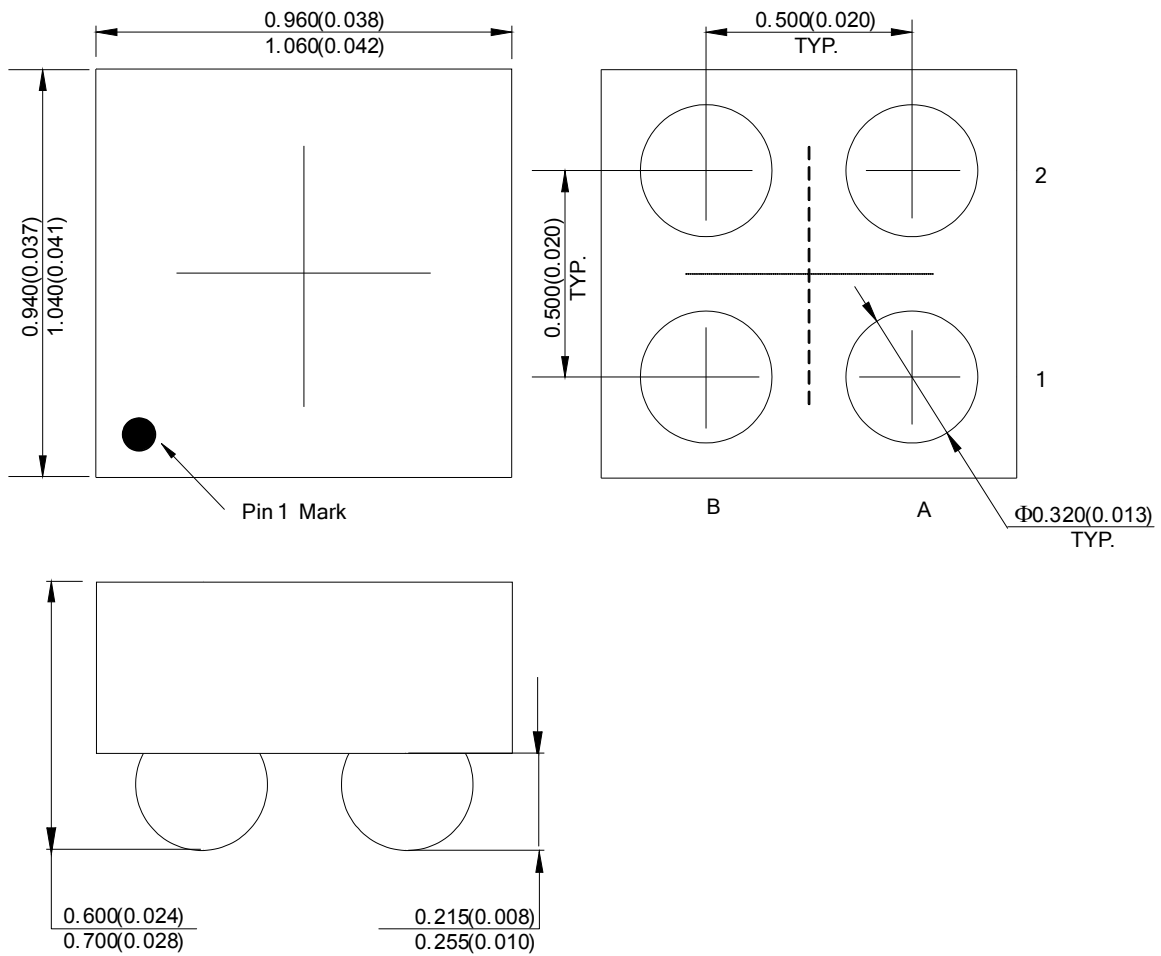



## **BCD Semiconductor Manufacturing Limited**

<http://www.bcdsemi.com>

### **IMPORTANT NOTICE**

BCD Semiconductor Manufacturing Limited reserves the right to make changes without further notice to any products or specifications herein. BCD Semiconductor Manufacturing Limited does not assume any responsibility for use of any its products for any particular purpose, nor does BCD Semiconductor Manufacturing Limited assume any liability arising out of the application or use of any its products or circuits. BCD Semiconductor Manufacturing Limited does not convey any license under its patent rights or other rights nor the rights of others.

---

#### **MAIN SITE**

##### **- Headquarters**

##### **BCD Semiconductor Manufacturing Limited**

No. 1600, Zi Xing Road, Shanghai Zizhu Science-based Industrial Park, 200241, China  
Tel: +86-21-24162266, Fax: +86-21-24162277

##### **- Wafer Fab**

##### **Shanghai SIM-BCD Semiconductor Manufacturing Co., Ltd.**

800 Yi Shan Road, Shanghai 200233, China  
Tel: +86-21-6485 1491, Fax: +86-21-5450 0008

#### **REGIONAL SALES OFFICE**

##### **Shenzhen Office**

##### **Shanghai SIM-BCD Semiconductor Manufacturing Co., Ltd., Shenzhen Office**

Unit A Room 1203, Skyworth Bldg., Gaoxin Ave. 1.S., Nanshan District, Shenzhen, China  
Tel: +86-755-8826 7951  
Fax: +86-755-8826 7865

##### **Taiwan Office**

##### **BCD Semiconductor (Taiwan) Company Limited**

4F, 298-1, Rui Guang Road, Nei-Hu District, Taipei, Taiwan  
Tel: +886-2-2656 2808  
Fax: +886-2-2656 2806

##### **USA Office**

##### **BCD Semiconductor Corp.**

30920 Huntwood Ave. Hayward, CA 94544, USA  
Tel : +1-510-324-2988  
Fax: +1-510-324-2788

## X-ON Electronics

Largest Supplier of Electrical and Electronic Components

*Click to view similar products for [LDO Voltage Regulators](#) category:*

*Click to view products by [Diodes Incorporated](#) manufacturer:*

Other Similar products are found below :

[M38D29FFHP#U1](#) [702103A](#) [717726C](#) [742457H](#) [MP20051DN-LF-Z](#) [R5F111PGGFB#30](#) [AP7363-SP-13](#) [NCP103AMX285TCG](#)  
[NCV8664CST33T3G](#) [NCV8752AMX28TCG](#) [L9454](#) [AP7362-HA-7](#) [LX13043CLD](#) [TCR3DF185,LM\(CT](#) [TCR3DF24,LM\(CT](#)  
[TCR3DF285,LM\(CT](#) [TCR3DF31,LM\(CT](#) [TCR3DF45,LM\(CT](#) [TLF4949EJ](#) [L9708](#) [L970813TR](#) [030014BB](#) [059985X](#) [EAN61387601](#)  
[EAN61573601](#) [NCP121AMX173TCG](#) [NCP4687DH15T1G](#) [NCV8703MX30TCG](#) [701326R](#) [702087BB](#) [755078E](#) [TCR2EN28,LF\(S](#)  
[LM1117DT-1.8/NO](#) [LT1086CM#TRPBF](#) [AZ1085S2-1.5TRE1](#) [MAX15101EWL+T](#) [NCV8170AXV250T2G](#) [SCD337BTG](#)  
[TCR3DF27,LM\(CT](#) [TCR3DF19,LM\(CT](#) [TCR3DF125,LM\(CT](#) [TCR2EN18,LF\(S](#) [MAX15103EWL+T](#) [TS2937CZ-5.0 C0](#) [MAX8878EUK30-](#)  
[T](#) [MAX663CPA](#) [NCV4269CPD50R2G](#) [NCV8716MT30TBG](#) [AZ1117IH-1.2TRG1](#) [MP2013GQ-P](#)