

Description

The AP2281 slew rate controlled load switch is a single P-channel MOSFET power switch designed for high-side load-switching applications. The MOSFET has a typical $R_{DS(ON)}$ of 80mΩ at 5V, allowing increased load current handling capacity with a low forward voltage drop. The turn-on slew rate of the device is controlled internally.

The AP2281 load switch is designed to operate from 1.5V to 6V, making it ideal for 1.8V, 2.5V, 3.3V, and 5V systems. The typical quiescent supply current is only 0.01μA.

Features

- Wide input voltage range: 1.5V – 6V
- Low $R_{DS(ON)}$: 80mΩ typical @ 5V
- Turn-on slew rate controlled
- AP2281-1: 1ms turn-on rise time
- AP2281-3: 100μs turn-on rise time with internal discharge
- Very low turn-on quiescent current: << 1μA
- Fast load discharge option
- Temperature range -40°C to +85°C
- **Lead-Free Finish; RoHS Compliant (Notes 1 & 2)**
- **Halogen and Antimony Free. "Green" Device (Note 3)**

Applications

- Smart Phones
- PDA
- Cell Phones
- GPS Navigators
- PMP/MP4
- Notebook and Pocket PC

- Notes:
1. EU Directive 2002/95/EC (RoHS) & 2011/65/EU (RoHS 2) compliant. All applicable RoHS exemptions applied.
 2. See http://www.diodes.com/quality/lead_free.html for more information about Diodes Incorporated's definitions of Halogen- and Antimony-free, "Green" and Lead-free.
 3. Halogen- and Antimony-free "Green" products are defined as those which contain <900ppm bromine, <900ppm chlorine (<1500ppm total Br + Cl) and <1000ppm antimony compounds.

Pin Assignments

(Top View)

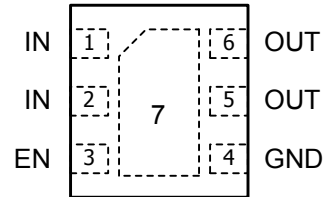

U-DFN2018-6

(Top View)

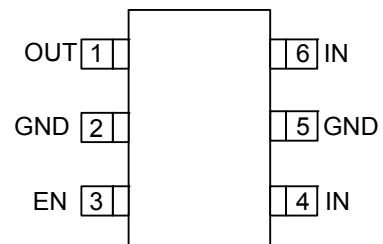

SOT26

Typical Applications Circuit

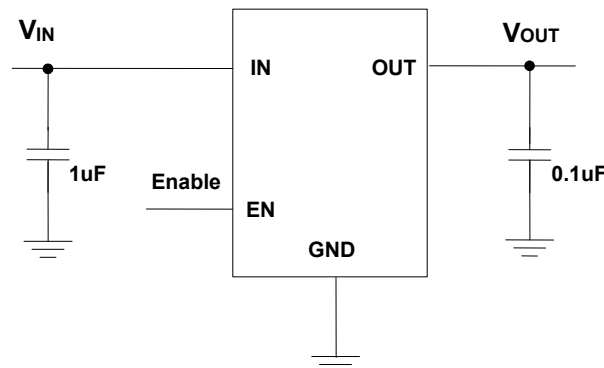

Pin Descriptions

Pin Name	Pin Number		Function
	SOT26	U-DFN2018-6	
OUT	1	5, 6	Voltage output pin. This is the pin to the P-channel MOSFET drain connection. Bypass to ground through a 0.1uF capacitor.
GND	2, 5	4	Ground.
EN	3	3	Enable input, active high
IN	4, 6	1, 2	Voltage input pin. This is the pin to the P-channel MOSFET source. Bypass to ground through a 1uF capacitor.
PAD		7	Thermal pad. Suggest connecting to ground plane to get better heat dissipation.

Options

Part Number	Slew Rate (typ)	Active Pull Down	Enable
AP2281-1	1ms	No	Active High
AP2281-3	100µs	Yes	Active High

Functional Block Diagram

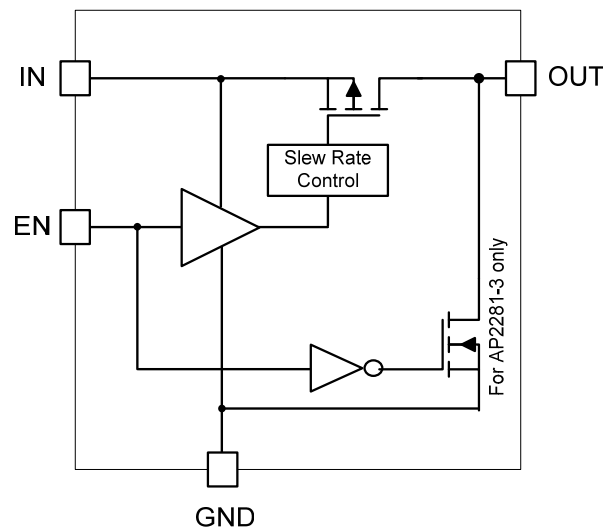

Absolute Maximum Ratings (@T_A = +25°C, unless otherwise specified.)

Symbol	Parameter		Ratings	Unit
ESD HBM	Human Body Model ESD Protection		5	KV
ESD MM	Machine Model ESD Protection	SOT26	500	V
		U-DFN2018-6	450	V
V _{IN}	Input Voltage		6.5	V
V _{OUT}	Output Voltage		V _{IN} +0.3	V
V _{EN}	Enable Voltage		6.5	V
I _{load}	Maximum Continuous Load Current		2	A
T _J	Operating Junction Temperature Range		-40 to +125	°C
T _{ST}	Storage Temperature Range		-65 to +150	°C
P _D	Power Dissipation	SOT26 (Note 4, 5, 6)	720	mW
		U-DFN2018-6 (Note 4, 5, 7)	1410	mW

- Notes: 4. T_J, max = +125°C.
5. Ratings apply to ambient temperature at +25°C.

Stresses greater than the 'Absolute Maximum Ratings' specified above, may cause permanent damage to the device. These are stress ratings only; functional operation of the device at these or any other conditions exceeding those indicated in this specification is not implied. Device reliability may be affected by exposure to absolute maximum rating conditions for extended periods of time.

Recommended Operating Conditions (@T_A = +25°C, unless otherwise specified.)

Symbol	Parameter	Min	Max	Unit
V _{IN}	Input voltage	1.5	6.0	V
I _{OUT}	Output Current	0	2.0	A
T _A	Operating Ambient Temperature	-40	+85	°C

Electrical Characteristics (@T_A = +25°C, unless otherwise specified.)

Symbol	Parameters	Test Conditions	Min	Typ	Max	Unit
I _Q	Input Quiescent Current	V _{EN} = V _{IN} , I _{OUT} = 0	—	0.01	1	μA
I _{SHDN}	Input Shutdown Current	V _{EN} = 0V, OUT open	—	0.01	1	μA
I _{LEAK}	Input Leakage Current	V _{EN} = 0V, OUT grounded	—	0.01	1	μA
R _{DS(ON)}	Switch on-resistance	V _{IN} = 5.0V	—	80	100	mΩ
		V _{IN} = 3.3V	—	95	120	mΩ
		V _{IN} = 1.8V	—	160	210	mΩ
		V _{IN} = 1.5V	—	210	280	mΩ
V _{IL}	EN Input Logic Low Voltage	V _{IN} = 1.5V to 6V	—	—	0.4	V
V _{IH}	EN Input Logic High Voltage	1.5V ≤ V _{IN} ≤ 2.7V	1.4	—	—	V
		2.7V < V _{IN} < 5.25V	1.6	—	—	V
		V _{IN} ≥ 5.25V	1.7	—	—	V
I _{SINK}	EN Input leakage	V _{EN} = 5V	—	—	1	μA
T _{D(ON)}	Output turn-on delay time	R _{LOAD} = 10Ω	—	1	—	μS
T _{ON}	Output turn-on rise time	AP2281-1, R _{LOAD} = 10Ω	—	1000	1500	μS
		AP2281-3, R _{LOAD} = 10Ω	—	100	150	μS
T _{D(OFF)}	Output turn-off delay time	R _{LOAD} = 10Ω	—	0.5	1	μS
R _{DISCH}	Discharge FET on-resistance	For AP2281-3 only, V _{EN} = GND	—	65	100	Ω
θ _{JA}	Thermal Resistance Junction-to-Ambient	SOT26 (Note 6)	—	153	—	°C/W
		U-DFN2018-6 (Note 7)	—	78	—	°C/W
θ _{JC}	Thermal Resistance Junction-to-case	SOT26 (Note 6)	—	29	—	°C/W
		U-DFN2018-6 (Note 7)	—	19	—	°C/W

- Notes: 6. Test condition for SOT26: Device mounted on FR-4 substrate PC board, 2oz copper, with minimum recommended pad layout.
7. Test condition for U-DFN2018-6: Device mounted on FR-4 2-layer board, 2oz copper, with minimum recommended pad on top layer and 3 vias to bottom layer 1.0"x1.4" ground plane.

Typical Performance Characteristics

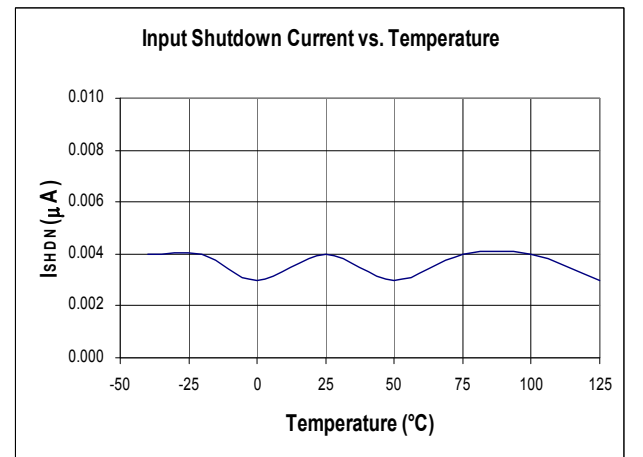
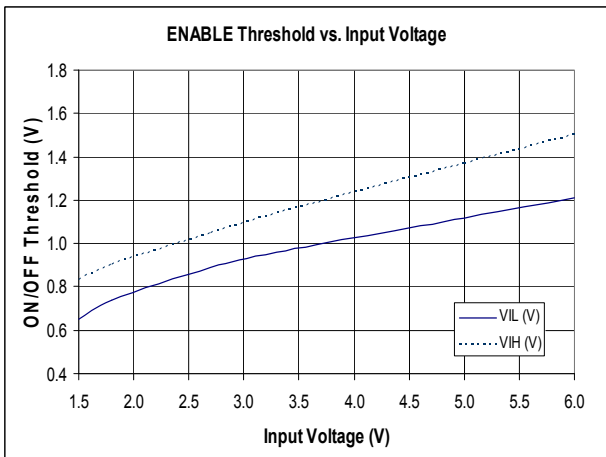
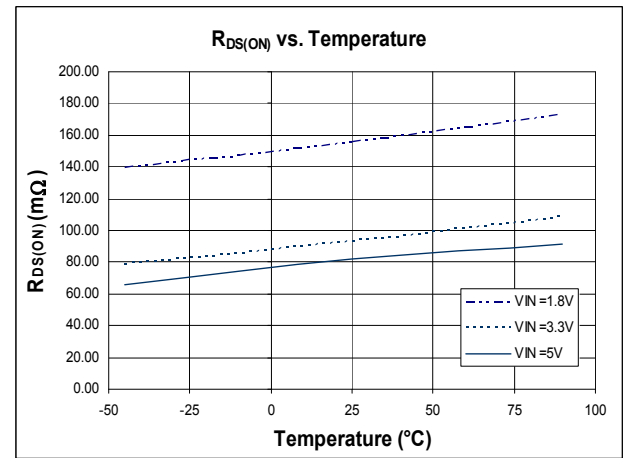
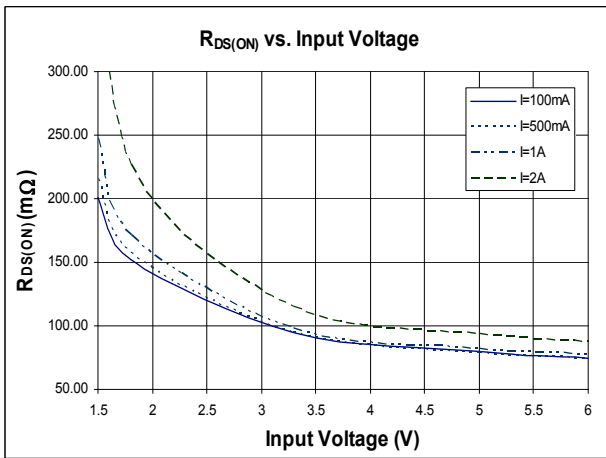
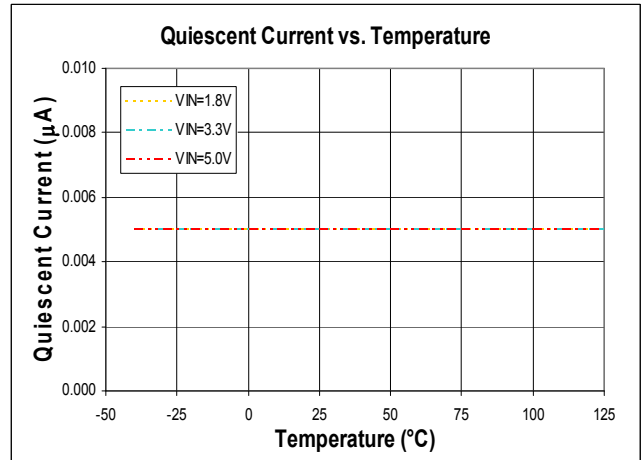
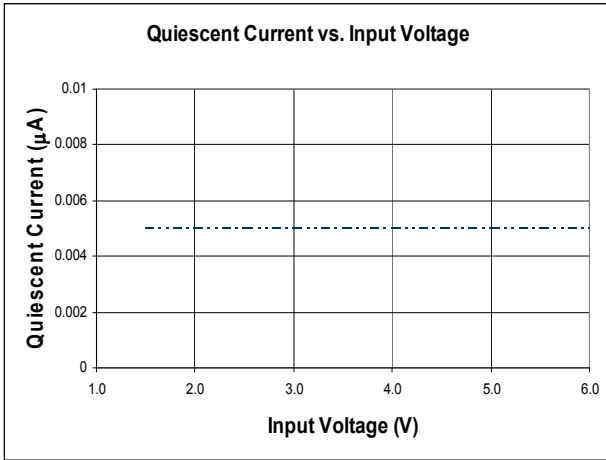

Typical Performance Characteristics (cont.)

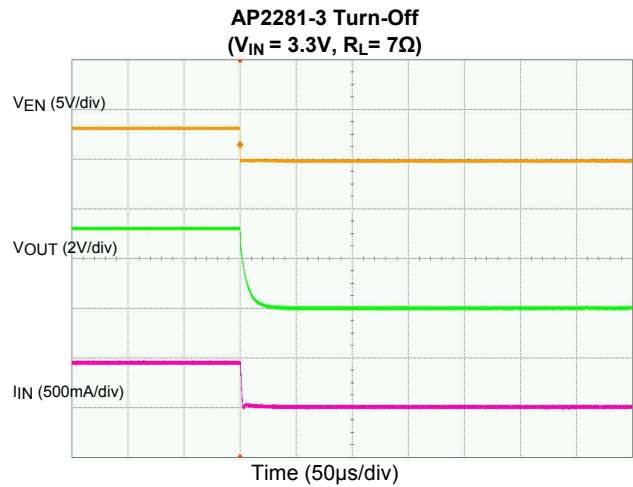
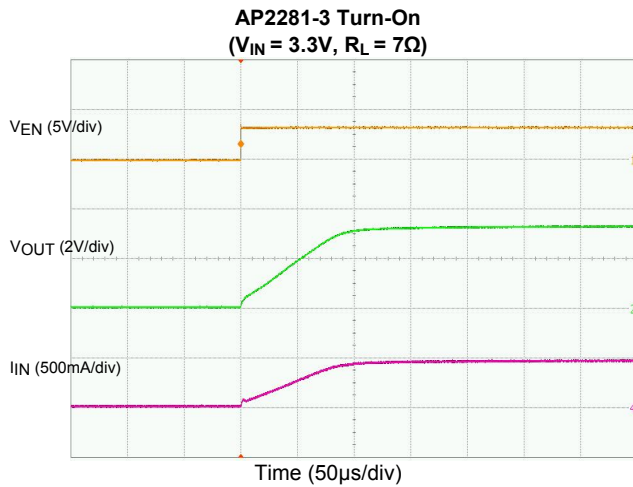
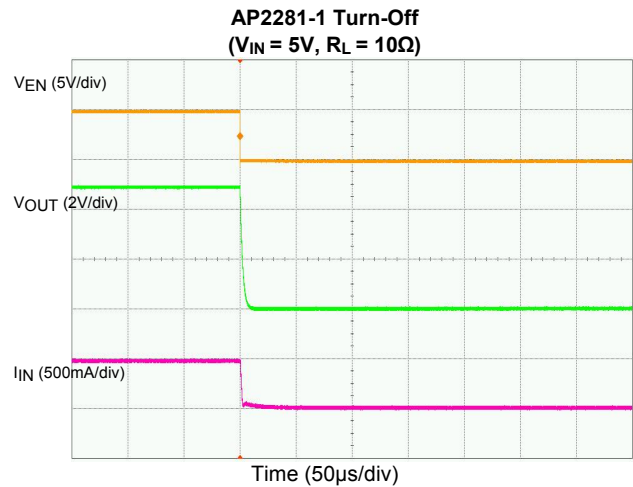
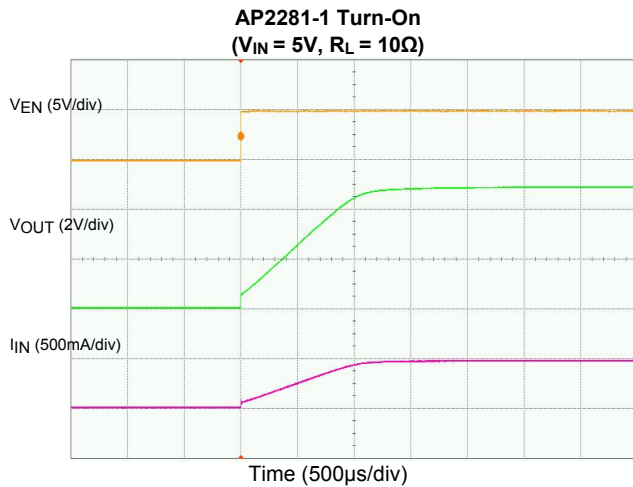
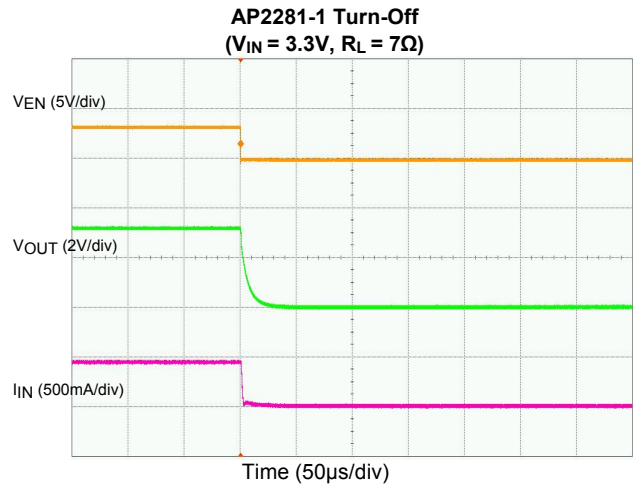
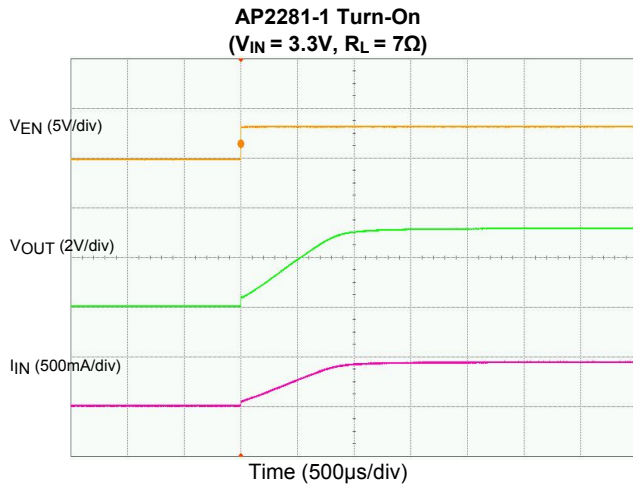

Typical Performance Characteristics (cont.)

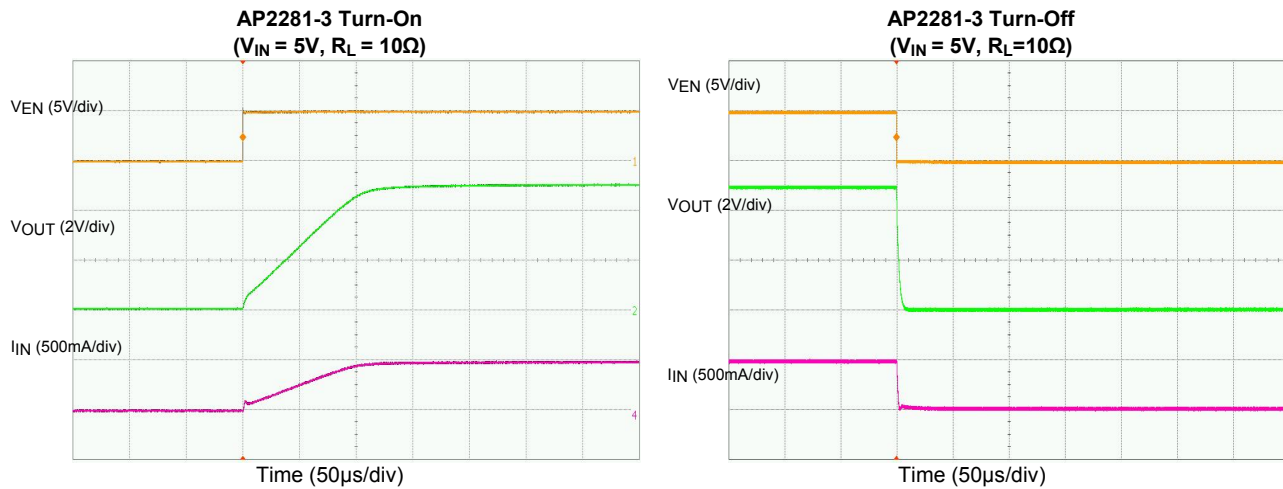

Application Notes

Input Capacitor

A 1µF capacitor is recommended to connect between IN and GND pins to decouple input power supply glitch and noise. The input capacitor has no specific type or ESR (Equivalent Series Resistance) requirement. However, for higher current application, ceramic capacitors are recommended due to their capability to withstand input current surges from low impedance sources, such as batteries in portable applications. This input capacitor must be located as close as possible to the device to assure input stability and less noise. For PCB layout, a wide copper trace is required for both IN and GND.

Output Capacitor

A 0.1µF capacitor is recommended to connect between OUT and GND pins to stabilize and accommodate load transient condition. The output capacitor has no specific type or ESR requirement. The amount of the capacitance may be increased without limit. For PCB layout, the output capacitor must be placed as close as possible to OUT and GND pins, and keep the traces as short as possible.

ENABLE/SHUTDOWN Operation

The AP2281 is turned on by setting the EN pin high, and is turned off by pulling it low. To ensure proper operation, the signal source used to drive the EN pin must be able to swing above and below the specified turn-on/off voltage thresholds listed in the Electrical Characteristics section under V_{IL} and V_{IH} .

DISCHARGE Operation

The AP2281-3 offers discharge option that helps to discharge the output charge when disabled.

Power Dissipation

The device power dissipation and proper sizing of the thermal plane is critical to avoid thermal shutdown and ensure reliable operation. Power dissipation of the device depends on input voltage and load conditions and can be calculated by:

$$P_D = I_{OUT}^2 \times R_{DS(on)} \quad (1)$$

However, the maximum power dissipation that can be handled by the device depends on the maximum junction to ambient thermal resistance, maximum ambient temperature, and maximum device junction temperature, which can be approximated by the equation below:

$$P_D(\max@T_A) = \frac{(+125^\circ\text{C} - T_A)}{\theta_{JA}} \quad (2)$$

For example at $V_{IN} = 5V$, the typical $R_{DS(on)} = 80m\Omega$. For $I_{OUT} = 2A$, the maximum power dissipation calculated using equation (1) is $P_D = 0.32W$. Based on SOT26 $\theta_{JA} = 153^\circ\text{C/W}$ and equation (2), the calculated junction temperature rise from ambient is approximately 49°C . Since the maximum junction temperature is 125°C , the operating ambient temperature must be kept below 76°C to safely operate the device.

Application Notes (cont.)

On the other hand, at $T_A = +85^\circ\text{C}$ and $V_{IN} = 5\text{V}$, the calculated maximum power dissipation from equation (2) is approximately $P_{D(\text{MAX})} = 0.26\text{W}$. Hence the safe operating maximum continuous current is 1.81A. For other application conditions, the users should recalculate the device maximum power dissipation based on the operating conditions.

Ordering Information

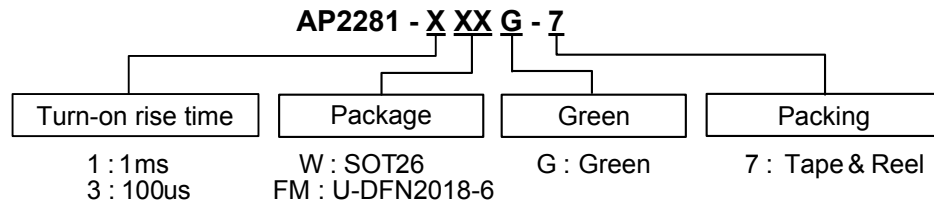

Part Number	Package Code	Packaging	7" Tape and Reel	
			Quantity	Part Number Suffix
AP2281-1WG-7	W	SOT26	3000/Tape & Reel	-7
AP2281-3WG-7	W	SOT26	3000/Tape & Reel	-7
AP2281-1FMG-7	FM	U-DFN2018-6	3000/Tape & Reel	-7
AP2281-3FMG-7	FM	U-DFN2018-6	3000/Tape & Reel	-7

Marking Information

(1) SOT26

(Top View)

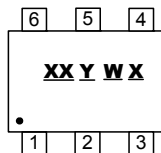

XX : Identification code
Y : Year 0~9
W : Week : A~Z : 1~26 week;
a~z : 27~52 week; z represents
52 and 53 week
X : A~Z : Green

Device	Package Type	Identification Code
AP2281-1W	SOT26	U2
AP2281-3W	SOT26	U3

(2) U-DFN2018-6

(Top View)

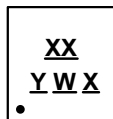

XX : Identification code
Y : Year 0~9
W : Week : A~Z : 1~26 week;
a~z : 27~52 week; z represents
52 and 53 week
X : A~Z : Green

Device	Package Type	Identification Code
AP2281-1FM	U-DFN2018-6	UE
AP2281-3FM	U-DFN2018-6	UF

Package Outline Dimensions (All dimensions in mm.)

Please see AP02002 at <http://www.diodes.com/datasheets/ap02002.pdf> for latest version.

(1) SOT26

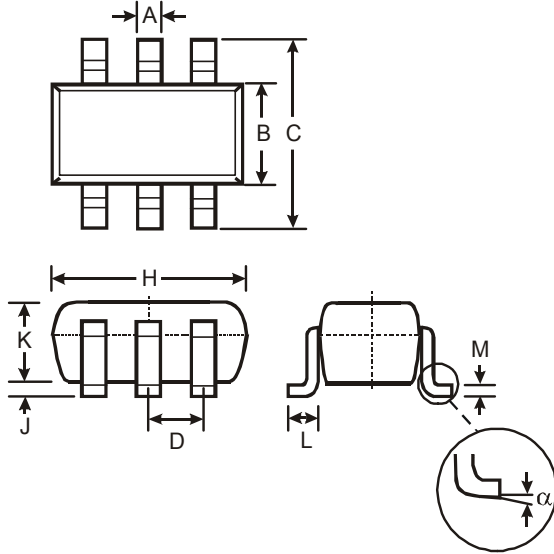

SOT26			
Dim	Min	Max	Typ
A	0.35	0.50	0.38
B	1.50	1.70	1.60
C	2.70	3.00	2.80
D	—	—	0.95
H	2.90	3.10	3.00
J	0.013	0.10	0.05
K	1.00	1.30	1.10
L	0.35	0.55	0.40
M	0.10	0.20	0.15
α	0°	8°	—
All Dimensions in mm			

(2) U-DFN2018-6

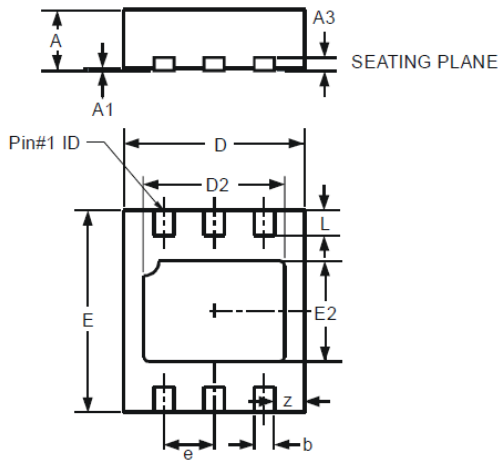

U-DFN2018-6			
Dim	Min	Max	Typ
A	0.545	0.605	0.575
A1	0	0.05	0.02
A3	—	—	0.13
b	0.15	0.25	0.20
D	1.750	1.875	1.80
D2	1.30	1.50	1.40
e	—	—	0.50
E	1.95	2.075	2.00
E2	0.90	1.10	1.00
L	0.20	0.30	0.25
z	—	—	0.30
All Dimensions in mm			

Suggested Pad Layout

Please see AP02001 at <http://www.diodes.com/datasheets/ap02001.pdf> for the latest version.

(1) SOT26

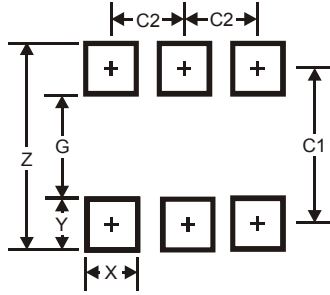

Dimensions	Value (in mm)
Z	3.20
G	1.60
X	0.55
Y	0.80
C1	2.40
C2	0.95

(2) U-DFN2018-6

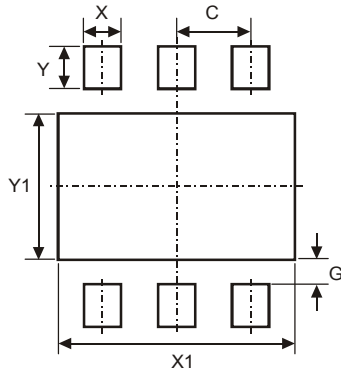

Dimensions	Value (in mm)
C	0.50
G	0.20
X	0.25
X1	1.60
Y	0.35
Y1	1.20

Taping Orientation

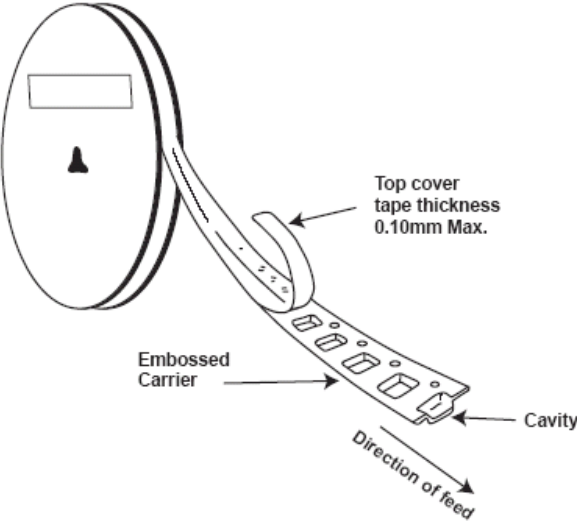
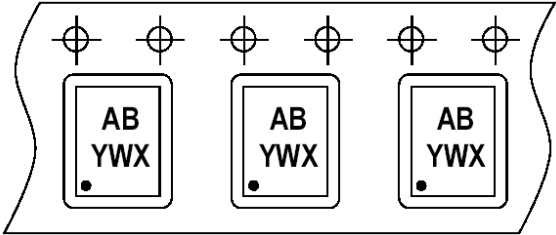

Note: 8. The taping orientation of the other package type can be found on our website at <http://www.diodes.com/datasheets/ap02007.pdf>

IMPORTANT NOTICE

DIODES INCORPORATED MAKES NO WARRANTY OF ANY KIND, EXPRESS OR IMPLIED, WITH REGARDS TO THIS DOCUMENT, INCLUDING, BUT NOT LIMITED TO, THE IMPLIED WARRANTIES OF MERCHANTABILITY AND FITNESS FOR A PARTICULAR PURPOSE (AND THEIR EQUIVALENTS UNDER THE LAWS OF ANY JURISDICTION).

Diodes Incorporated and its subsidiaries reserve the right to make modifications, enhancements, improvements, corrections or other changes without further notice to this document and any product described herein. Diodes Incorporated does not assume any liability arising out of the application or use of this document or any product described herein; neither does Diodes Incorporated convey any license under its patent or trademark rights, nor the rights of others. Any Customer or user of this document or products described herein in such applications shall assume all risks of such use and will agree to hold Diodes Incorporated and all the companies whose products are represented on Diodes Incorporated website, harmless against all damages.

Diodes Incorporated does not warrant or accept any liability whatsoever in respect of any products purchased through unauthorized sales channel. Should Customers purchase or use Diodes Incorporated products for any unintended or unauthorized application, Customers shall indemnify and hold Diodes Incorporated and its representatives harmless against all claims, damages, expenses, and attorney fees arising out of, directly or indirectly, any claim of personal injury or death associated with such unintended or unauthorized application.

Products described herein may be covered by one or more United States, international or foreign patents pending. Product names and markings noted herein may also be covered by one or more United States, international or foreign trademarks.

This document is written in English but may be translated into multiple languages for reference. Only the English version of this document is the final and determinative format released by Diodes Incorporated.

LIFE SUPPORT

Diodes Incorporated products are specifically not authorized for use as critical components in life support devices or systems without the express written approval of the Chief Executive Officer of Diodes Incorporated. As used herein:

A. Life support devices or systems are devices or systems which:

1. are intended to implant into the body, or
2. support or sustain life and whose failure to perform when properly used in accordance with instructions for use provided in the labeling can be reasonably expected to result in significant injury to the user.

B. A critical component is any component in a life support device or system whose failure to perform can be reasonably expected to cause the failure of the life support device or to affect its safety or effectiveness.

Customers represent that they have all necessary expertise in the safety and regulatory ramifications of their life support devices or systems, and acknowledge and agree that they are solely responsible for all legal, regulatory and safety-related requirements concerning their products and any use of Diodes Incorporated products in such safety-critical, life support devices or systems, notwithstanding any devices- or systems-related information or support that may be provided by Diodes Incorporated. Further, Customers must fully indemnify Diodes Incorporated and its representatives against any damages arising out of the use of Diodes Incorporated products in such safety-critical, life support devices or systems.

Copyright © 2013, Diodes Incorporated

www.diodes.com

X-ON Electronics

Largest Supplier of Electrical and Electronic Components

Click to view similar products for [Power Switch ICs - Power Distribution](#) *category:*

Click to view products by [Diodes Incorporated](#) *manufacturer:*

Other Similar products are found below :

[TCK111G,LF\(S\)](#) [FPF1018](#) [DS1222](#) [TCK2065G,LF](#) [SZNCP3712ASNT3G](#) [MIC2033-05BYMT-T5](#) [MIC2033-12AYMT-T5](#) [MIC2033-05BYM6-T5](#) [SLG5NT1437VTR](#) [SZNCP3712ASNT1G](#) [DML1008LDS-7](#) [KTS1670EDA-TR](#) [KTS1640QGDV-TR](#) [KTS1641QGDV-TR](#) [U6513A](#) [MIC2012YM-TR](#) [MP5095GJ-P](#) [TPS2021IDRQ1](#) [TPS2104DBVR](#) [MIC2098-1YMT-TR](#) [MIC94062YMT TR](#) [MIC2015-1.2YM6 TR](#) [MIC2075-2YM](#) [MIC94068YML-TR](#) [SIP32461DB-T2-GE1](#) [NCP335FCT2G](#) [FPF1504UCX](#) [TCK105G,LF\(S\)](#) [AP2411S-13](#) [AP2151DSG-13](#) [AP2172MPG-13](#) [MIC94094YC6-TR](#) [MIC94093YC6-TR](#) [MIC94064YC6-TR](#) [MIC94061YMT-TR](#) [MIC2505-1YM](#) [MIC94085YFT-TR](#) [MIC94042YFL-TR](#) [MIC2005-1.2YM6-TR](#) [SIP32510DT-T1-GE3](#) [NCP333FCT2G](#) [NCP331SNT1G](#) [TPS2092DR](#) [TPS2063DR](#) [MIC2008YML-TR](#) [MIC94084YFT-TR](#) [DIO1280WL12](#) [BTS70202EPAXUMA1](#) [AP22814ASN-7](#) [MIC2043-2YTS](#)