

Description

The AP3436/A is a step-down DC-DC converter with integrated power stage capable of driving up to 3A continuous output current. It integrates 2 N-channel power MOSFETs with low on-resistance. Current mode control provides fast transient response and cycle-by-cycle current limit.

For AP3436, the regulator adopts current-mode in forced pulse-width modulation (PWM) mode with 1.25MHz switching frequency internally, which allows small-sized components, such as capacitors and inductors. This feature greatly simplifies the design of switch-mode power supplies. Under PWM mode, the device remains at the fixed PWM operation (typical at 1.25MHz), regardless of if the load current is high or low.

For AP3436A, the regulator operates in either fixed PWM mode or a pulse-skipping modulation (PSM) mode depending on the different load conditions. The device can operate at typical 1.25MHz fixed switching frequency under heavy load condition. At light load, the regulator enters a PSM mode to minimize the switching loss by reducing the switching frequency.

The AP3436/A provides EN function. Pulling this pin high statically enables the device while pulling the pin low statically for longer than 10 μ s will shut it down.

Under Voltage Lockout is internally set at 2.75V for V_{CC} detection. The output voltage startup ramp is controlled by the soft start. An open drain power good signal indicates the output is within 75% to 125% of its nominal voltage.

The AP3436/A is available in U-DFN3030-10 package.

Applications

- Desktop & Notebook
- Low Voltage, High Density Power System
- Consumer Application Such as Set Top Box, LCD Display and CPE Equipment

Notes:

1. No purposely added lead. Fully EU Directive 2002/95/EC (RoHS) & 2011/65/EU (RoHS 2) compliant.
2. See http://www.diodes.com/quality/lead_free.html for more information about Diodes Incorporated's definitions of Halogen- and Antimony-free, "Green" and Lead-free.
3. Halogen- and Antimony-free "Green" products are defined as those which contain <900ppm bromine, <900ppm chlorine (<1500ppm total Br + Cl) and <1000ppm antimony compounds.

Pin Assignments

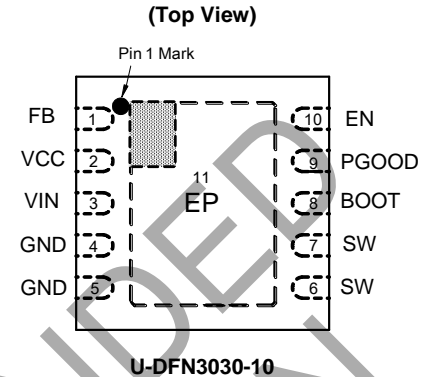

Features

- Analog Power Input V_{CC} Range: 3.0V to 5.5V
- Power Input V_{IN} Range: 1.3V to 5.5V
- 0.6V Reference Voltage with $\pm 1.5\%$ Precision
- 2 MOSFETs (Typ 50m Ω) for High Efficiency at 3A Loads
- High Efficiency: Up to 95%
- Output Current: 3A
- Current Mode Control
- Built-in Soft Start Function
- UV and OV Power Good Output
- Built-in UV and OV Protection Function
- Built-in Over Current Protection
- Built-in Thermal Shutdown Function
- Thermally Enhanced 3mmx3mm DFN Package
- **Totally Lead-Free & Fully RoHS Compliant (Notes 1 & 2)**
- **Halogen and Antimony Free. "Green" Device (Note 3)**

Typical Applications Circuit

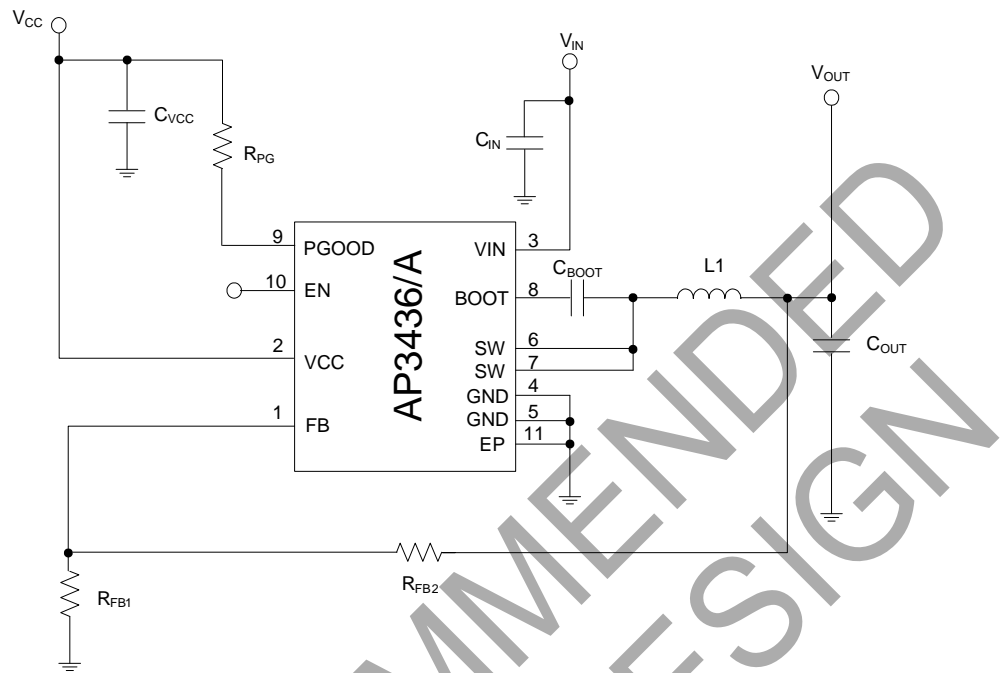

Note 4: When using a single power supply for V_{CC} and V_{IN}, a 4.7Ω resistor should be placed between them for noise isolation.

Component	Value	Unit	Component	Value	Unit
C _{VCC}	1	μF	C _{IN}	44	μF
R _{PG}	10	kΩ	C _{BOOT}	0.1	μF
R _{FB2}	TBD	kΩ	L1	1.5	μH
R _{FB1}	TBD	kΩ	C _{OUT}	88	μF

Table 1. Component Guide

Pin Descriptions

Pin Number	Pin Name	Function
1	FB	Voltage Feedback Input. Connect to V _{OUT} through a voltage divider to set the output voltage
2	VCC	Analog Power Input
3	VIN	Power Input
4, 5	GND	Ground. Must be Connected to GND on PCB
6, 7	SW	Power Switch Output
8	BOOT	High Side Switch Driver Supply
9	PGOOD	Open Drain Power Good Output
10	EN	Enable
11	Exposed Pad	Thermal Connection to the PCB. Must be connected to GND on PCB

Functional Block Diagram

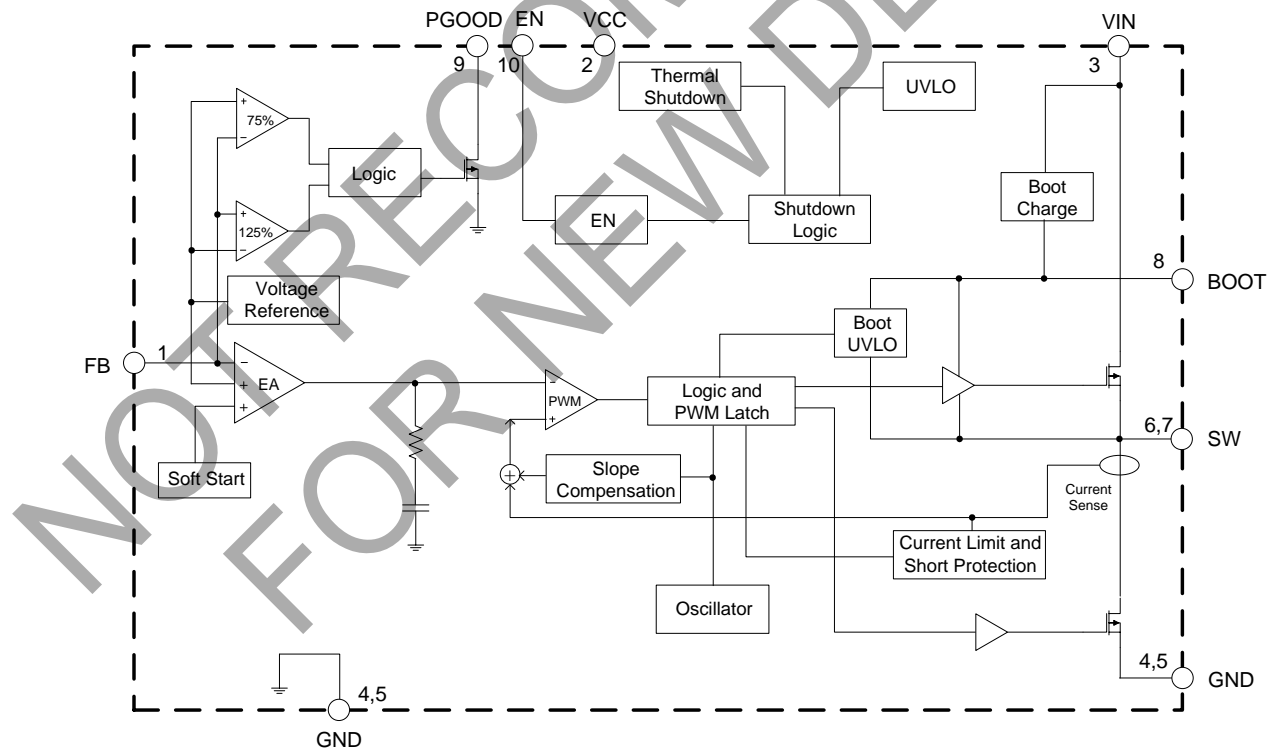

Absolute Maximum Ratings (Note 5)

Symbol	Parameter	Rating	Unit
V _{CC} , V _{IN}	VCC, VIN Pin Voltage	-0.3 to 6	V
V _{EN}	EN Pin Voltage	-0.3 to 6	V
V _{SW}	SW Pin Voltage	-0.3 to V _{IN} +0.3	V
V _{SW_TRANSIENT}	SW Pin Transient Voltage (<50ns)	-5 to V _{IN} +5	V
V _{FB}	FB Pin Voltage	-0.3 to 6	V
V _{PGD}	PGOOD Pin Voltage	-0.3 to 6	V
V _{BOOT_SW}	BOOT to SW Voltage	0 to 6	V
θ _{JA}	Thermal Resistance (Junction to Ambient, Simulation)	33	°C/W
θ _{JC}	Thermal Resistance (Junction to Case)	3	°C/W
T _J	Operating Junction Temperature	-40 to +150	°C
T _{STG}	Storage Temperature	-65 to +150	°C
T _{LEAD}	Lead Temperature (Soldering, 10sec)	+260	°C
V _{HBM}	ESD (Human Body Model)	2000	V
V _{MM}	ESD (Machine Model)	200	V

Note 5: Stresses greater than those listed under "Absolute Maximum Ratings" may cause permanent damage to the device. These are stress ratings only, and functional operation of the device at these or any other conditions beyond those indicated under "Recommended Operating Conditions" is not implied. Exposure to "Absolute Maximum Ratings" for extended periods may affect device reliability.

Recommended Operating Conditions

Symbol	Parameter	Min	Max	Unit
V _{CC}	Analog Input Voltage	3.0	5.5	V
V _{IN}	Power Input Voltage	1.3	5.5	V
I _{OUT(MAX)}	Maximum Output Current	3	–	A
V _{OUT}	Output Voltage	0.8	V _{IN}	V
T _A	Operating Ambient Temperature	-40	+85	°C

Electrical Characteristics ($V_{CC} = 5V$, $V_{IN} = 5V$, $T_A = +25^\circ C$, unless otherwise specified.)

Symbol	Parameter	Conditions	Min	Typ	Max	Unit
SUPPLY VOLTAGE (VCC, VIN PIN)						
V_{CC}	Analog Power Input Voltage	–	3.0	–	5.5	V
V_{IN}	Power Input Voltage	–	1.3	–	5.5	V
I_Q	Quiescent Current	$V_{FB} = 1.5V$, $V_{CC} = 5V$, $V_{IN} = 5V$	–	400	–	μA
I_{SHDN}	Shutdown Supply Current	$V_{EN} = 0V$, $3.0V \leq V_{CC} \leq 5.5V$, $1.3V \leq V_{IN} \leq 5.5V$	–	–	1	μA
POWER ON RESET						
V_{UVLO}	Internal Under Voltage Lockout Threshold for V_{CC}	–	–	2.75	2.85	V
V_{HYS_VCC}	Internal Under Voltage Hysteresis for V_{CC}	–	–	150	–	mV
VOLTAGE REFERENCE (FB PIN)						
V_{FB}	Voltage Reference	$3.0V \leq V_{CC} \leq 5.5V$	0.591	0.600	0.609	V
INTERNAL PWM FREQUENCY						
f	PWM Frequency	$3.0V \leq V_{CC} \leq 5.5V$	1.0	1.25	1.5	MHz
MOSFET SPEC						
R_{ON_H}	High Side Switch On-resistance	$V_{BOOT_SW} = 5.0V$	–	50	100	m Ω
		$V_{BOOT_SW} = 3.0V$	–	70	140	m Ω
R_{ON_L}	Low Side Switch On-resistance	$V_{CC} = 5.0V$	–	50	100	m Ω
		$V_{CC} = 3.0V$	–	70	140	m Ω
CURRENT LIMIT						
I_{LIMIT}	Current Limit Threshold	–	4.8	7.6	–	A
THERMAL SHUTDOWN						
T_{TSD}	Thermal Shutdown	–	–	+160	–	$^\circ C$
–	Hysteresis	–	–	+20	–	$^\circ C$
BOOT SPEC (BOOT PIN)						
R_{BOOT}	BOOT Charge Resistor	$V_{CC} = 5.0V$	–	16	–	Ω
–	BOOT to SW UVLO	$V_{CC} = 3.0V$	–	2.2	–	V
SOFT START						
t _{SS}	Soft Start Time	–	0.8	–	2	ms

Electrical Characteristics (Cont. $V_{CC} = 5V$, $V_{IN} = 5V$, $T_A = +25^\circ C$, unless otherwise specified.)

Symbol	Parameter	Conditions	Min	Typ	Max	Unit
ENABLE (EN PIN)						
V_{EN_L}	EN Pin Threshold	–	–	–	0.8	V
V_{EN_H}		–	1.6	–	–	V
POWER GOOD (PGOOD PIN)						
V_{FBTH}	Feedback Threshold	V_{FB} falling (Fault)	70	75	–	% V_{REF}
		V_{FB} rising (Good)	77	82	–	
		V_{FB} rising (Fault)	–	125	130	
		V_{FB} falling (Good)	–	118	123	
t_{PG_DLY}	Delay Time for PGOOD from High to Low	–	–	30	–	μs
R_{PG}	Internal Power Good Pull Low Resistance	–	–	–	150	Ω
R_{PG_UP}	External Pull-up Resistance Range	–	3000	–	–	Ω
SYSTEM PERFORMANCE						
V_{UVP}	Output Under Voltage Protection Threshold	$V_{IN} = 1.3$ to $5.5V$	–	–	$0.5 \times V_{OUT}$	V
t_{UVP}	Delay Time for UVP Triggered	$V_{IN} = 1.5$ to $5V$	–	65	–	μs
V_{OVP}	Output Over Voltage Protection Threshold	$V_{IN} = 1.3$ to $5.5V$	$1.5 \times V_{OUT}$	–	–	V
t_{OVP}	Delay Time for OVP Triggered	$V_{IN} = 1.5$ to $5V$	–	65	–	μs
I_{OUT}	Output Current	$V_{IN} = 1.5$ to $5V$, $V_{OUT} = 1.0V$	3	–	–	A
–	Output Voltage Line Regulation	$V_{IN} = 1.5$ to $5V$, $I_{OUT} = 100mA$	–	0.4	–	$\% \times V_{OUT}/V$
–	Output Voltage Load Regulation	$I_{OUT} = 0A$ to $3A$	–	0.3	–	$\% \times V_{OUT}/A$
V_{TRAN}	Output Voltage Load Transient	$V_{IN} = 5V$, $V_{OUT} = 1.0V$, $dl/dt = 400mA/\mu s$	–	± 2.5	–	$\% \times V_{OUT}/A$
η	Efficiency	$V_{CC} = 5V$, $V_{IN} = 5V$, $I_{OUT} = 3A$, $V_{OUT} = 1.2V$	–	80	–	%

Performance Characteristics

Efficiency vs. Output Current

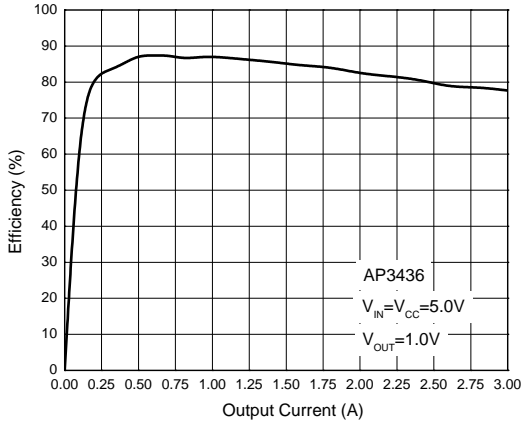

Reference Voltage vs. Input Voltage

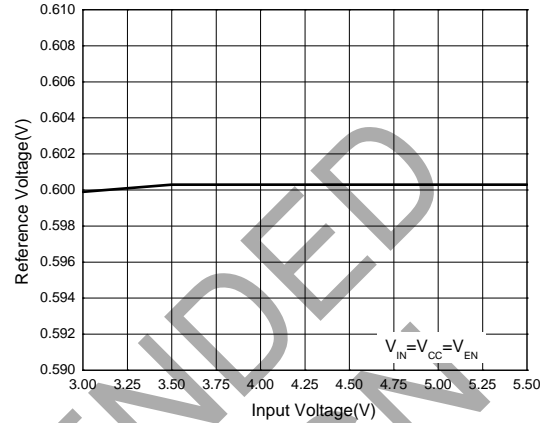

Reference Voltage vs. Temperature

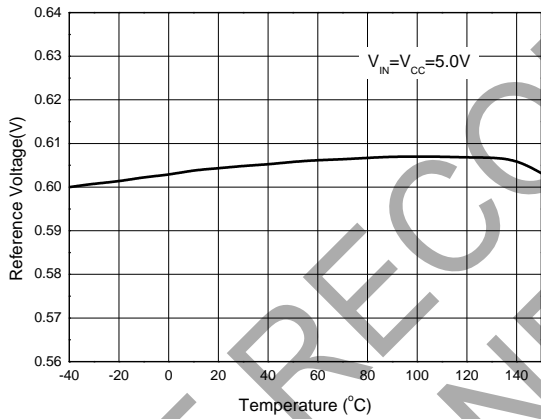

PWM Frequency vs. Input Voltage

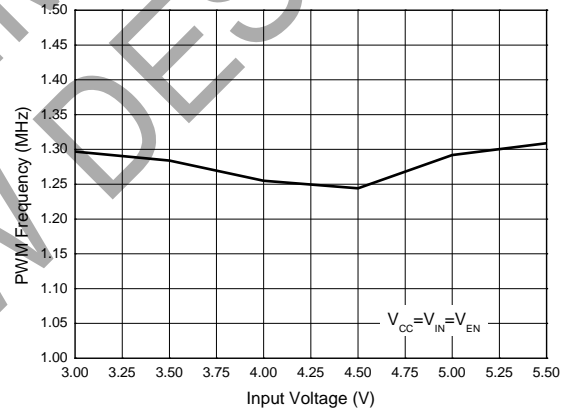

PWM Frequency vs. Temperature

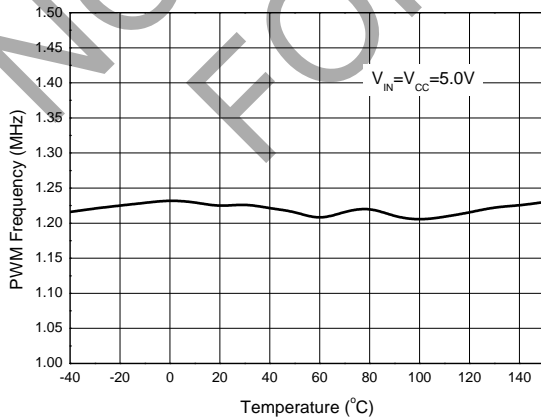

Current Limit vs. Input Voltage

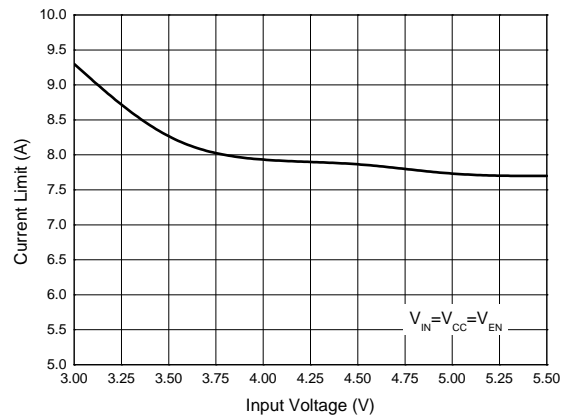

Performance Characteristics (Cont.)

Current Limit vs. Temperature

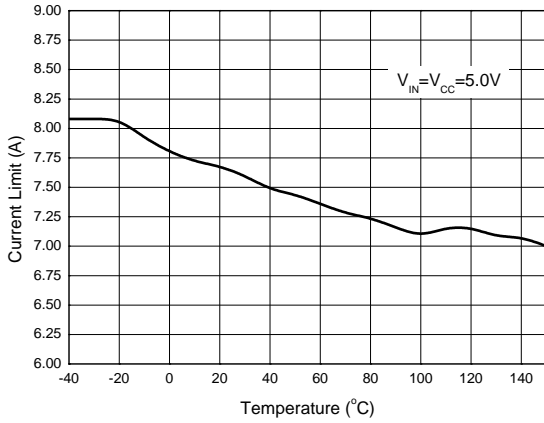

Line Regulation vs. Input Voltage

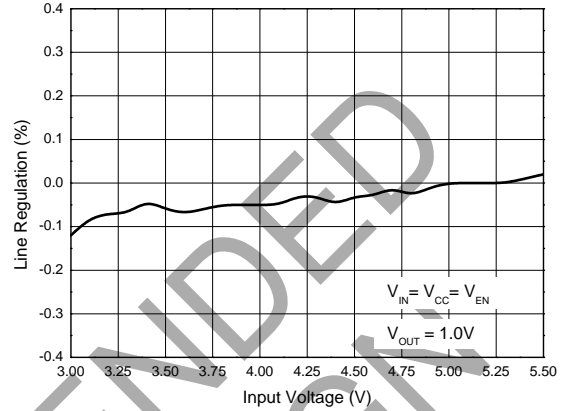

Load Regulation vs. Output Current

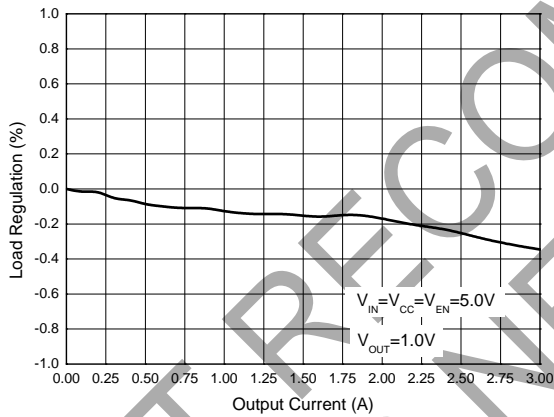

**Power on Waveform
(V_IN = V_CC = 5V, V_OUT = 1V, I_OUT = 3A)**

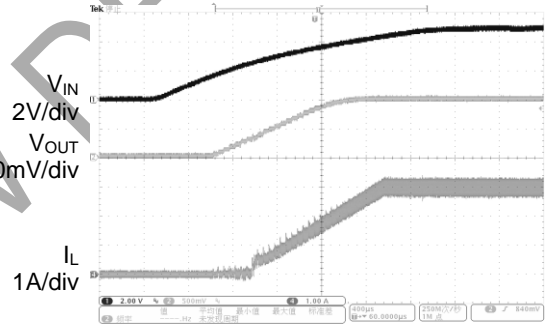

Time 400µs/div

**Power off Waveform
(V_IN = V_CC = 5V, V_OUT = 1V, I_OUT = 3A)**

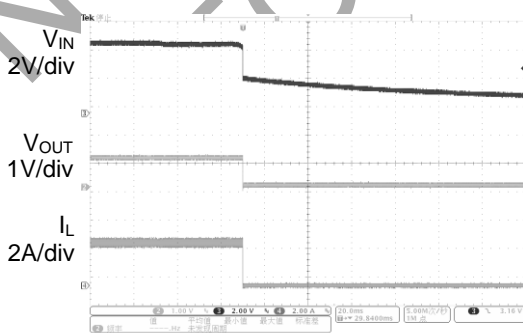

**Enable Waveform
(V_IN = V_CC = 5V, V_OUT = 1V, I_OUT = 3A)**

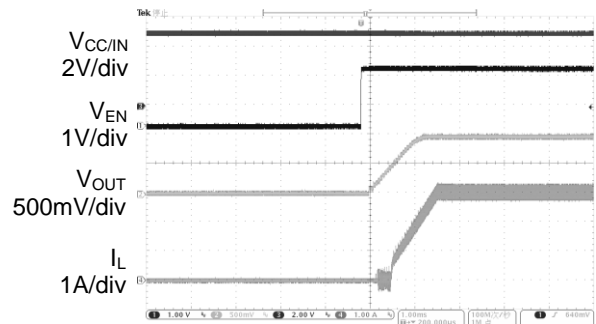

Time 1ms/div

Performance Characteristics (Cont.)

Disable Waveform
($V_{IN}=V_{CC}=5V$, $V_{OUT}=1V$, $I_{OUT}=3A$)

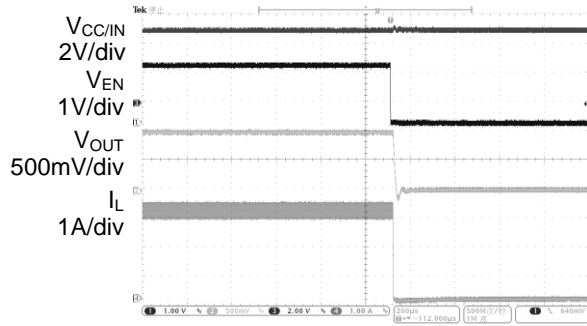

Time 200 μ s/div

Load Transient Response
($V_{IN}=V_{CC}=5V$, $V_{OUT}=1V$, $I_{OUT}=0$ to 3A)

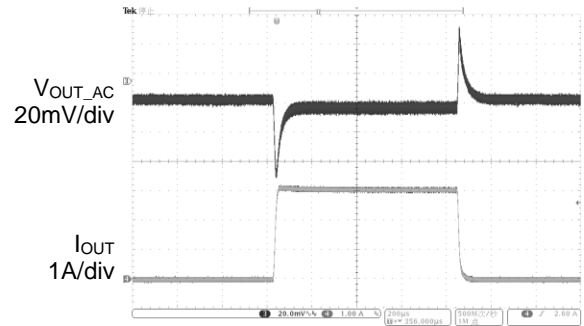

Time 200 μ s/div

Load Transient Response
($V_{IN}=V_{CC}=3.3V$, $V_{OUT}=1V$, $I_{OUT}=0$ to 3A)

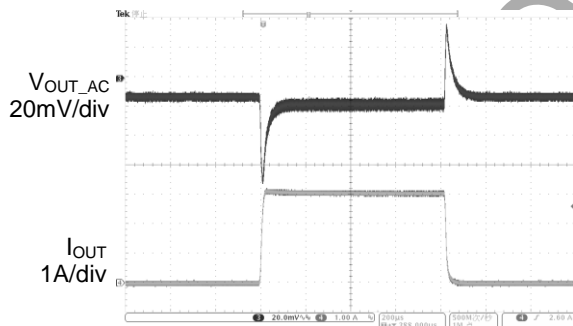

Time 200 μ s/div

NOT FOR COMMERCIAL NEW DESIGN

Application Information

1. Overview

The AP3436/A is a 3A synchronous buck (step-down) converter with two integrated N-channel MOSFETs. For AP3436, the regulator operates in PWM mode with 1.25MHz switching frequency internally, regardless of if the load current is high or low. For AP3436A, when the load is very light, the regulator automatically operates in the PSM mode to minimize the switching loss, thus achieving high efficiency at light load. When the load increases, the regulator automatically switches over to a current-mode PWM operating at nominal 1.25MHz switching frequency.

2. Power On Reset

A Power On Reset (POR) circuitry continuously monitors the supply voltage at VCC pin. Once the rising POR threshold is exceeded, the AP3436/A sets itself to active state and is ready to accept chip enable command. The rising POR threshold is typically 2.75V.

3. Soft Start

A built-in soft-start is used to prevent surge current from power supply input V_{IN} during turn on (Referring to the Functional Block Diagram). The error amplifier is a three-input device. Reference voltage V_{REF} or the internal soft-start voltage V_{SS} whichever is smaller dominates the behavior of the non-inverting inputs of the error amplifier. V_{SS} internally ramps up to 0.6V after the soft-start cycle is initiated. The ramp is created digitally, so the output voltage will follow the V_{SS} signal and ramps up smoothly to its target level.

4. EN Function

The AP3436/A provides Enable Function. Pulling this pin higher than 1.6V statically enables the AP3436/A while pulling the pin lower than 0.8V statically for longer than 10 μ s will shutdown the IC.

5. Adjusting Output Voltage

The output voltage is set with a resistor divider from the FB pin. It is recommended to use divider resistors with 1% tolerance or better. Start with a 100k Ω for the resistor R1 and use the following equation to calculate R2. Consider using larger value resistors to improve efficiency at very light loads. If the values are too high, the regulator is more susceptible to noise and the voltage errors caused by FB input current are noticeable.

$$R2 = \frac{R1 \times 0.6}{V_{OUT} - 0.6}$$

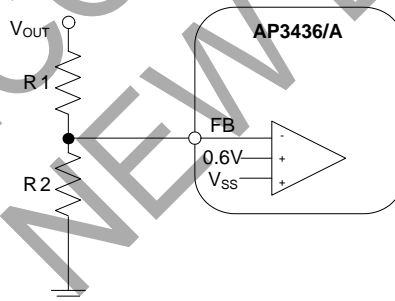

Figure 1. Voltage Divider Circuit

6. Short Circuit Protection (SCP)

The AP3436/A has Over Current Protection (OCP) and Under Voltage Protection (UVP) functions.

6.1 OCP Function

The high side switch current is detected during each cycle. During SCP conditions, the output voltage is pulled down and the switch current is increased. Once the increased high side switching current is detected to trigger the current limit of high side switch, the high side switch will be immediately turned off and will not be turned on again until the next switching cycle. When over current condition is removed, the AP3436/A will recover back to normal operation again.

6.2 UVP Function

The FB voltage is also monitored for Under Voltage Protection. The UV threshold is set at 0.2V. The under voltage protection has 65 μ s triggered delay. When UVP is triggered, both high side and low side are shutdown immediately. The UVP is a latched function, reset power supply or EN pin to restart AP3436/A again.

Application Information (Cont.)

7. Over Voltage Protection (OVP)

The output voltage is continuously monitored for Over Voltage Protection by FB pin. When it is larger than 1.67 times as setting, the OVP function is triggered. The Over Voltage Protection has 65 μ s triggered delay.

When OVP is triggered, both high side and low side are shutdown immediately and the output voltage is discharged by an internal 1k Ω resistor.

8. Power Good

The PGOOD pin output connects an open drain MOSFET. The output is pulled low when the FB voltage enters the fault condition by falling below 75% or rising above 125% of the nominal internal reference voltage. There is a 7% hysteresis on the threshold voltage, so when the FB voltage rises to the good condition above 82% or falls below 118% of the internal voltage reference the PGOOD output MOSFET is turned off. It is recommended to use a pull-up resistor between the values of 3k Ω and 100k Ω to a voltage source that is 5V or less.

9. Thermal Shutdown

The device implements an internal thermal shutdown to protect itself if the junction temperature exceeds +160 $^{\circ}$ C. Switching is stopped when the junction temperature exceeds the thermal trip threshold. Once the die temperature decreases below +140 $^{\circ}$ C, the device reinitiates the soft start operation. The thermal shutdown hysteresis is +20 $^{\circ}$ C.

NOT RECOMMENDED
FOR NEW DESIGN

Ordering Information

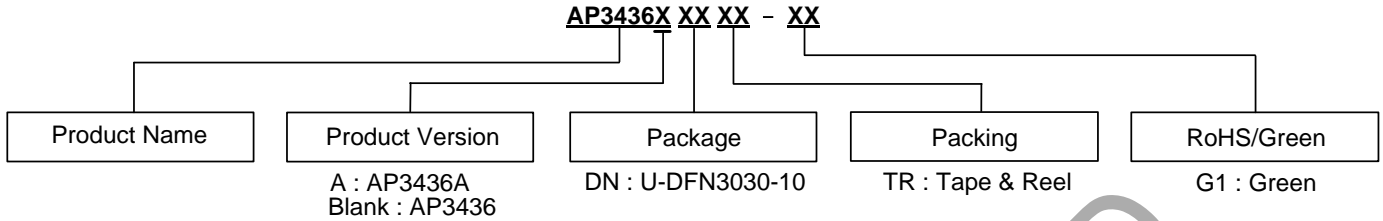

Package	Temperature Range	Function	Part Number	Marking ID	Packing
U-DFN3030-10	-40 to +85°C	PWM	AP3436DNTR-G1	BDB	5000/Tape & Reel
		PWM/PSM	AP3436ADNTR-G1	BDF	5000/Tape & Reel

Marking Information

AP3436

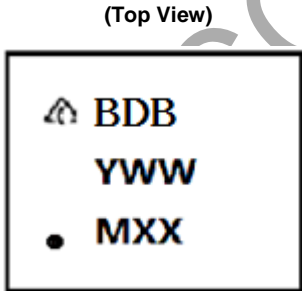

First Line: Logo and Marking ID
 Second and Third Lines: Date Code
 Y: Year
 WW: Work Week of Molding
 M: Assembly House Code
 XX: 7th and 8th Digits of Batch No.

AP3436A

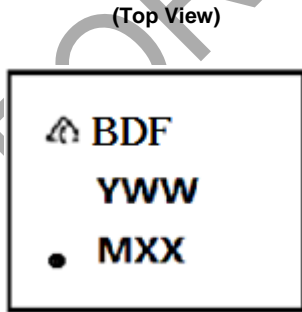

First Line: Logo and Marking ID
 Second and Third Lines: Date Code
 Y: Year
 WW: Work Week of Molding
 M: Assembly House Code
 XX: 7th and 8th Digits of Batch No.

Package Outline Dimensions (All dimensions in mm(inch).)

(1) Package Type: U-DFN3030-10

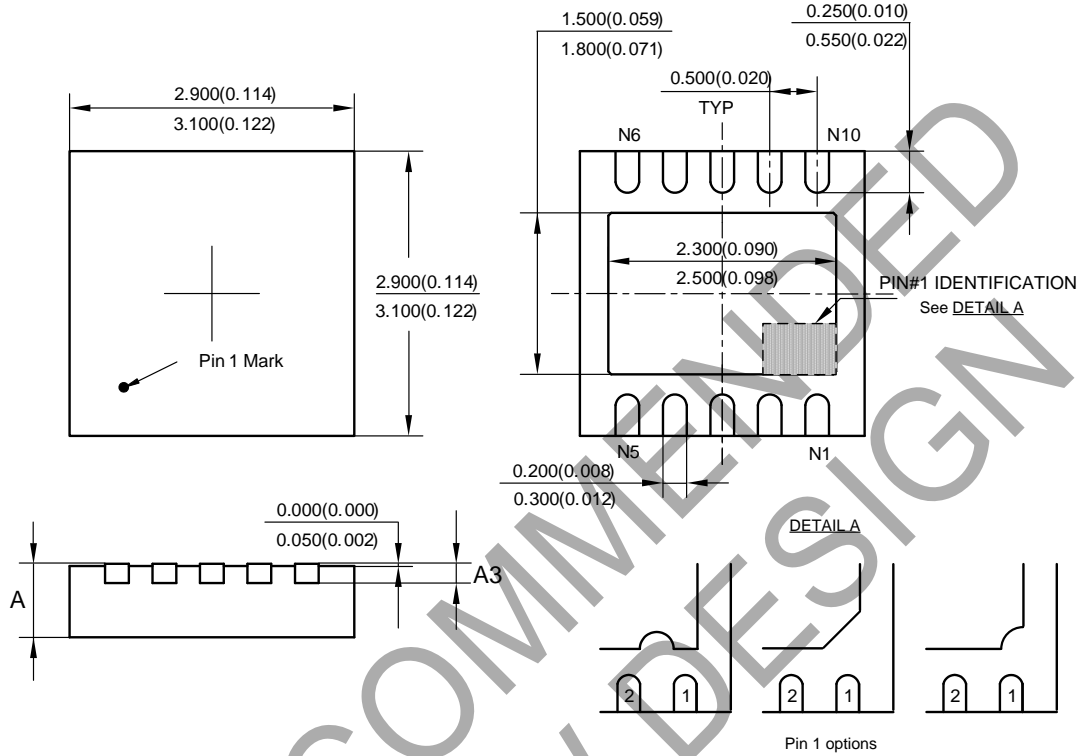

Symbol	A				A3			
	min(mm)	max(mm)	min(inch)	max(inch)	min(mm)	max(mm)	min(inch)	max(inch)
Option 1	0.700	0.800	0.028	0.031	0.153	0.253	0.006	0.010
Option 2	0.570	0.630	0.022	0.025	0.150 (Typ)		0.006 (Typ)	

Suggested Pad Layout

(1) Package Type: U-DFN3030-10

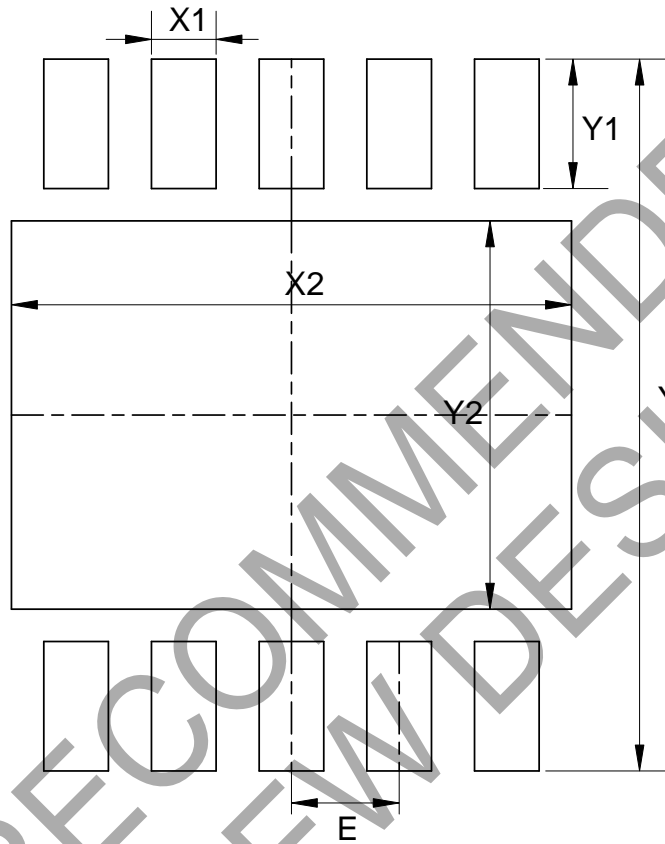

Dimensions	Y (mm)/(inch)	X1 (mm)/(inch)	Y1 (mm)/(inch)	X2 (mm)/(inch)	Y2 (mm)/(inch)	E (mm)/(inch)
Value	3.300/0.130	0.300/0.012	0.600/0.024	2.600/0.102	1.800/0.071	0.500/0.020

IMPORTANT NOTICE

DIODES INCORPORATED MAKES NO WARRANTY OF ANY KIND, EXPRESS OR IMPLIED, WITH REGARDS TO THIS DOCUMENT, INCLUDING, BUT NOT LIMITED TO, THE IMPLIED WARRANTIES OF MERCHANTABILITY AND FITNESS FOR A PARTICULAR PURPOSE (AND THEIR EQUIVALENTS UNDER THE LAWS OF ANY JURISDICTION).

Diodes Incorporated and its subsidiaries reserve the right to make modifications, enhancements, improvements, corrections or other changes without further notice to this document and any product described herein. Diodes Incorporated does not assume any liability arising out of the application or use of this document or any product described herein; neither does Diodes Incorporated convey any license under its patent or trademark rights, nor the rights of others. Any Customer or user of this document or products described herein in such applications shall assume all risks of such use and will agree to hold Diodes Incorporated and all the companies whose products are represented on Diodes Incorporated website, harmless against all damages.

Diodes Incorporated does not warrant or accept any liability whatsoever in respect of any products purchased through unauthorized sales channel. Should Customers purchase or use Diodes Incorporated products for any unintended or unauthorized application, Customers shall indemnify and hold Diodes Incorporated and its representatives harmless against all claims, damages, expenses, and attorney fees arising out of, directly or indirectly, any claim of personal injury or death associated with such unintended or unauthorized application.

Products described herein may be covered by one or more United States, international or foreign patents pending. Product names and markings noted herein may also be covered by one or more United States, international or foreign trademarks.

This document is written in English but may be translated into multiple languages for reference. Only the English version of this document is the final and determinative format released by Diodes Incorporated.

LIFE SUPPORT

Diodes Incorporated products are specifically not authorized for use as critical components in life support devices or systems without the express written approval of the Chief Executive Officer of Diodes Incorporated. As used herein:

A. Life support devices or systems are devices or systems which:

1. are intended to implant into the body, or
2. support or sustain life and whose failure to perform when properly used in accordance with instructions for use provided in the labeling can be reasonably expected to result in significant injury to the user.

B. A critical component is any component in a life support device or system whose failure to perform can be reasonably expected to cause the failure of the life support device or to affect its safety or effectiveness.

Customers represent that they have all necessary expertise in the safety and regulatory ramifications of their life support devices or systems, and acknowledge and agree that they are solely responsible for all legal, regulatory and safety-related requirements concerning their products and any use of Diodes Incorporated products in such safety-critical, life support devices or systems, notwithstanding any devices- or systems-related information or support that may be provided by Diodes Incorporated. Further, Customers must fully indemnify Diodes Incorporated and its representatives against any damages arising out of the use of Diodes Incorporated products in such safety-critical, life support devices or systems.

Copyright © 2017, Diodes Incorporated

www.diodes.com

X-ON Electronics

Largest Supplier of Electrical and Electronic Components

Click to view similar products for [Switching Voltage Regulators](#) category:

Click to view products by [Diodes Incorporated](#) manufacturer:

Other Similar products are found below :

[FAN53610AUC33X](#) [FAN53611AUC123X](#) [FAN48610BUC33X](#) [FAN48610BUC45X](#) [FAN48617UC50X](#) [R3](#) [430464BB](#) [MIC45116-1YMP-T1](#) [KE177614](#) [MAX809TTR](#) [NCV891234MW50R2G](#) [NCP81103MNTXG](#) [NCP81203PMNTXG](#) [NCP81208MNTXG](#) [NCP81109GMNTXG](#) [SCY1751FCCT1G](#) [NCP81109JMNTXG](#) [AP3409ADNTR-G1](#) [LTM8064IY](#) [LT8315EFE#TRPBF](#) [NCV1077CSTBT3G](#) [DA9121-B0V76](#) [LTC3644IY#PBF](#) [LD8116CGL](#) [HG2269M/TR](#) [OB2269](#) [XD3526](#) [U6215A](#) [U6215B](#) [U6620S](#) [LTC3803ES6#TR](#) [LTC3803ES6#TRM](#) [LTC3412IFE](#) [LT1425IS](#) [MAX25203BATJA/VY+](#) [MAX77874CEWM+](#) [XC9236D08CER-G](#) [ISL95338IRTZ](#) [MP3416GJ-P](#) [BD9S201NUX-CE2](#) [MP5461GC-Z](#) [MPQ4415AGQB-Z](#) [MPQ4590GS-Z](#) [LX7178-01CSP-TR](#) [MCP1642B-18IMC](#) [MCP1642D-ADJIMC](#) [MCP1642D-18IMC](#) [MCP1642D-30IMC](#) [MCP1665T-E/MRA](#) [MIC2876-4.75YMT-T5](#)