

Description

The APX803S is used for microprocessor (μ P) supervisory circuits to monitor the power supplies in μ P and digital systems. They provide excellent circuit reliability and low cost by eliminating external components and adjustments when used with 5.0V, 3.3V, 3.0V and 2.5V powered circuits.

These circuits perform a single function: they assert a reset signal on power up and whenever the V_{CC} supply voltage declines below a preset threshold, keeping it asserted for a fixed period of time after V_{CC} has risen above the reset threshold. For the APX803S this period is a minimum of 1ms while for other APX803S variants it is at least 140ms. The reset comparator is designed to ignore fast transients on V_{CC} , and the outputs are guaranteed to be in the correct logic state for V_{CC} down to 1V.

The APX803S is available with different reset thresholds suitable for operation with a variety of supply voltages. The APX803S has an open drain active low $\overline{\text{RESET}}$ output and compliment Diodes APX809S/810S which have push-pull output stages. Low supply current makes the APX803S ideal for use in portable equipment. The APX803S is available in two pin out variants of the 3-pin SOT23 package.

Features

- Precision Monitoring of 2.5V, 3.0V, 3.3V, and 5.0V Power-Supply Voltages
- Fully Specified Over Temperature
- Open-drain $\overline{\text{RESET}}$ Active Low
- Power-On/Power Supply Glitch Reset Pulse
 - APX803S00 1.7ms (Typ.)
 - APX803S05 50ms (Typ.)
 - APX803S 240ms (Typ.)
- 10 μ A Supply Current (Typ.)
- Guaranteed Reset Valid to $V_{CC} = 1V$
- **Totally Lead-Free & Fully RoHS Compliant (Note 1 & 2)**
- **Halogen and Antimony Free. "Green" Device (Note 3)**

- Notes:
1. No purposely added lead. Fully EU Directive 2002/95/EC (RoHS) & 2011/65/EU (RoHS 2) compliant.
 2. See http://www.diodes.com/quality/lead_free.html for more information about Diodes Incorporated's definitions of Halogen- and Antimony-free, "Green" and Lead-free.
 3. Halogen- and Antimony-free "Green" products are defined as those which contain <900ppm bromine, <900ppm chlorine (<1500ppm total Br + Cl) and <1000ppm antimony compounds.

Pin Assignments

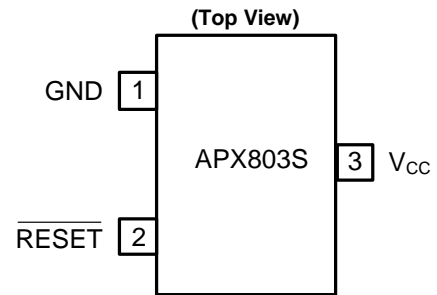

SOT23 (SA Package)

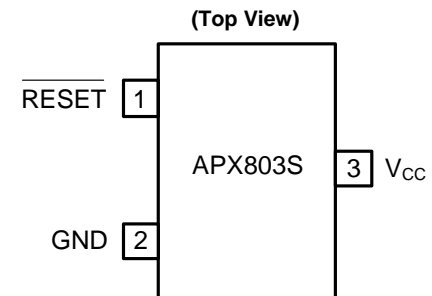

SOT23 (SR Package)

Applications

- Computers
- Controllers
- Intelligent Instruments
- Critical μ P and μ C Power Monitoring
- Portable/Battery Powered Equipment

Typical Applications Circuit

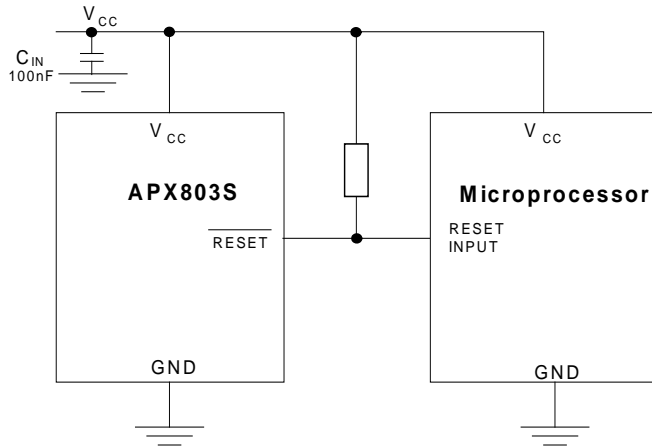

Pin Descriptions

Pin Number		Pin Name	Description
SOT23 (SA Package)	SOT23 (SR Package)		
1	2	GND	Ground
2	1	$\overline{\text{RESET}}$	Reset Output Pin Active Low Open Drain
3	3	V _{CC}	Operating Voltage Input

Functional Block Diagram

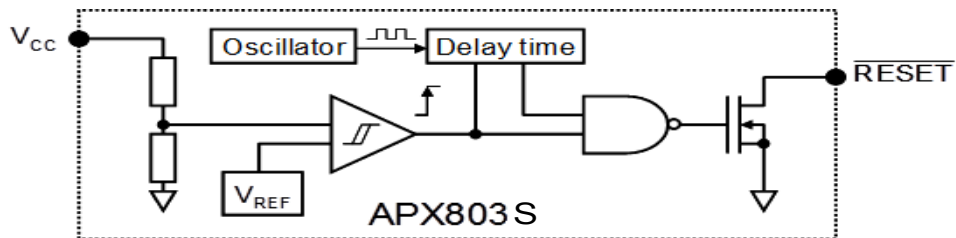

Absolute Maximum Ratings (@T_A = +25°C, unless otherwise specified.)

Symbol	Parameter	Rating	Unit
ESD HBM	Human Body Model ESD Protection	3	kV
ESD MM	Machine Model ESD Protection	400	V
ESD CDM	Charged Device Model ESD Protection	1500	V
V _{CC}	Supply Voltage	-0.3 to +6.0	V
$\overline{\text{V}}_{\text{RESET}}$	$\overline{\text{RESET}}$ (Open Drain)	-0.3 to 6	V
I _{CC}	Input Current, V _{CC}	20	mA
I _O	Output Current, $\overline{\text{RESET}}$	20	mA
θ _{JA}	Thermal Resistance Junction-to-Ambient (SOT23 Package)	232	°C/W
θ _{JC}	Thermal Resistance Junction-to-Case (SOT23 Package)	87	°C/W
T _J	Junction Temperature	+150	°C
T _{ST}	Storage Temperature Range	-65 to +150	°C
dV _{CC} /dt	V _{CC} Rate of Rise (V _{CC} = 0 to V _T)	100	V/μs

NEW PRODUCT

Recommended Operating Conditions (@ $T_A = +25^\circ\text{C}$, unless otherwise specified.)

Symbol	Parameter	Min	Max	Unit
V_{CC}	Supply Voltage	1.0	5.5	V
$V_{\overline{\text{RESET}}}$	$\overline{\text{RESET}}$ Output Voltage	0	5.5	V
T_A	Operating Ambient Temperature Range	-40	+85	$^\circ\text{C}$

Electrical Characteristics (Typical values are @ $T_A = +25^\circ\text{C}$, unless otherwise specified.)

Symbol	Parameter	Test Conditions	Min	Typ.	Max	Unit	
I_{CC}	Supply Current	$V_{TH} + 0.2V$	—	10	15	μA	
V_{TH}	Reset Threshold	$T_A = +25^\circ\text{C}$	APX803SXX-23	2.21	2.25	2.30	V
			APX803SXX-26	2.59	2.63	2.67	
			APX803SXX-29	2.89	2.93	2.97	
			APX803SXX-31	3.04	3.08	3.13	
			APX803SXX-40	3.94	4.00	4.06	
			APX803SXX-44	4.31	4.38	4.45	
			APX803SXX-46	4.56	4.63	4.70	
—	Reset Threshold Tempco	$T_A = -40^\circ\text{C}$ to $+85^\circ\text{C}$	—	30	—	ppm/ $^\circ\text{C}$	
t_s	V_{CC} to $\overline{\text{RESET}}$ Delay	$V_{CC} = V_{TH}$ to $(V_{TH} - 100\text{mV})$	—	20	—	μs	
t_{DELAY}	Reset Active Timeout Period	$V_{CC} \geq 1.02 \times V_{TH}$	APX803S-XX	140	240	280	ms
			APX803S05-XX	20	50	70	
			APX803S00-XX	1	1.7	3.3	
V_{OL}	$\overline{\text{RESET}}$ Output Voltage Low	$V_{CC} = V_{TH} - 0.2V$, $I_{\text{SINK}} = 1.2\text{mA}$	—	—	0.3	V	
		$V_{CC} = V_{TH} - 0.2V$, $I_{\text{SINK}} = 3.5\text{mA}$	—	—	0.4		
		$V_{CC} > 1.0V$, $I_{\text{SINK}} = 50\mu\text{A}$	—	—	0.3		
I_{OH}	$\overline{\text{RESET}}$ Output High Leakage Current	$V_{CC} > V_{TH} + 0.2V$	—	—	1	μA	

Performance Characteristics

NEW PRODUCT

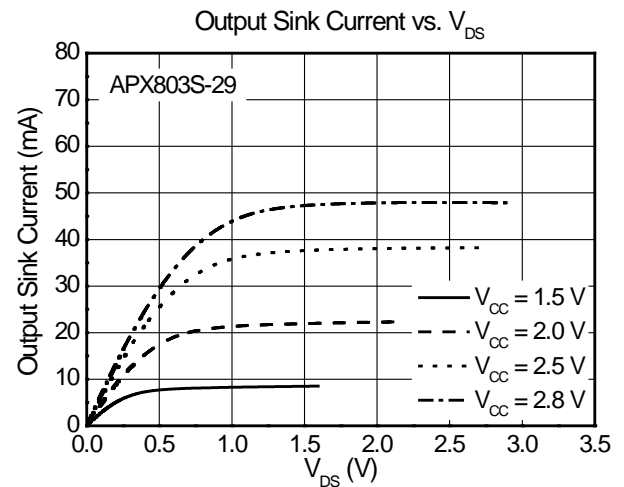
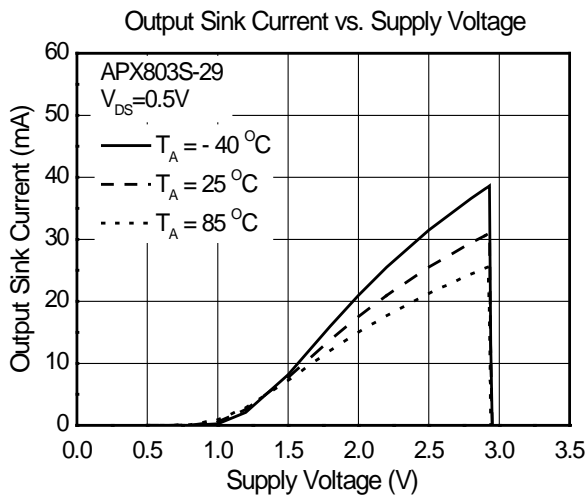
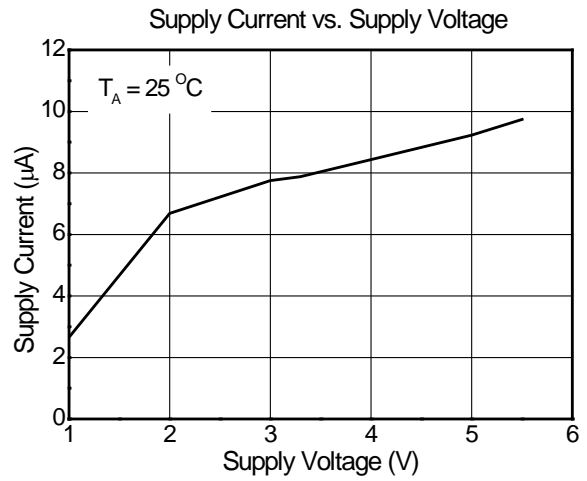
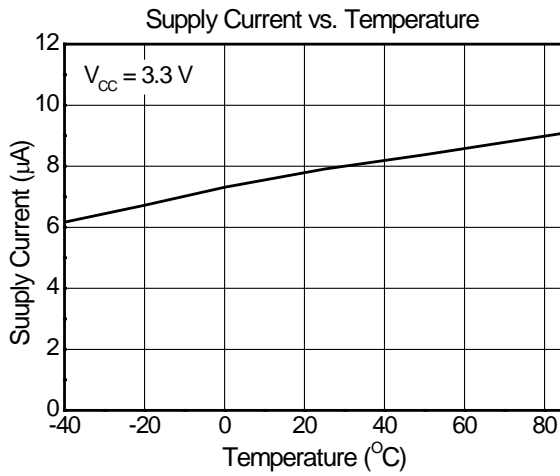
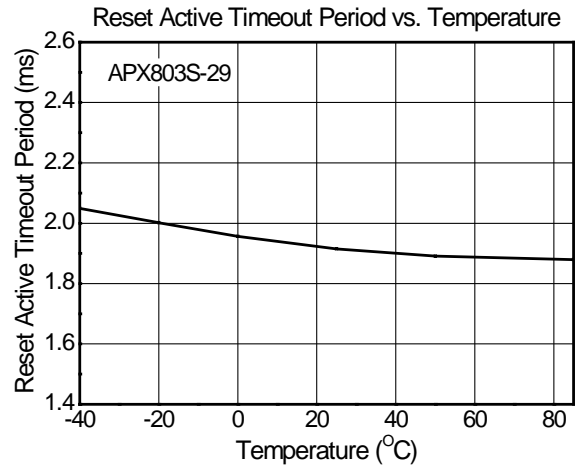
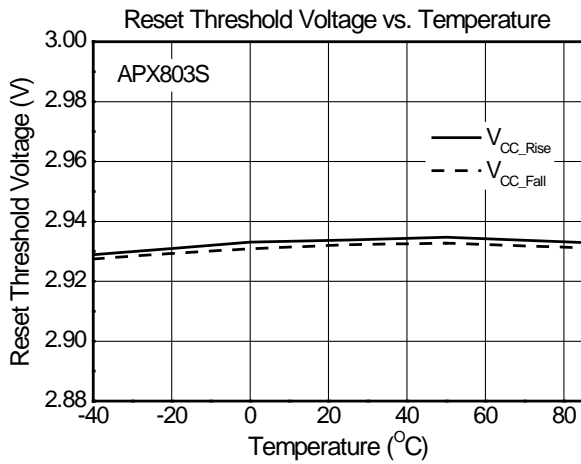

Timing Diagram

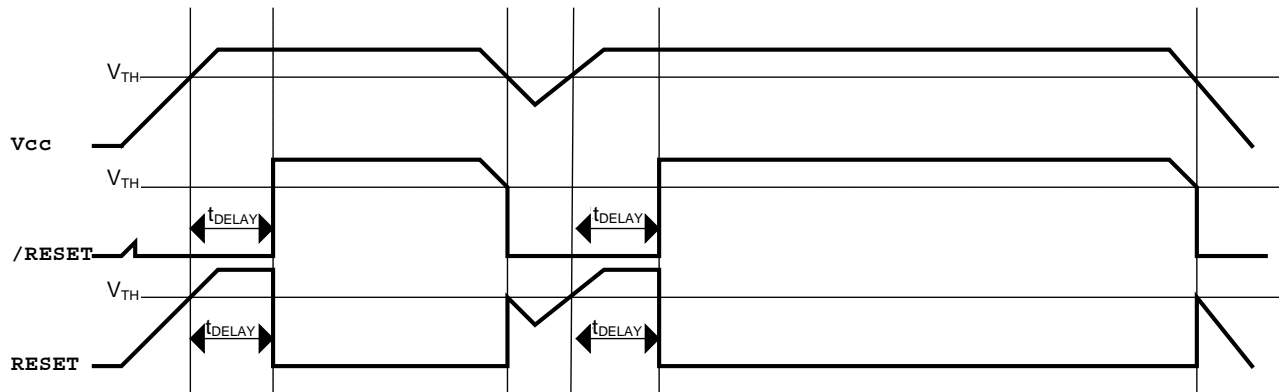

Functional Description

Microprocessors (μPs) and microcontrollers (μC) have a reset input to ensure that it starts up in a known state. The APX803S drive the μP 's reset input to prevent code-execution errors during power-up, power-down, or brownout conditions. They assert a reset signal whenever the V_{CC} supply voltage declines below a preset threshold and keep it asserted for a fixed period of time after V_{CC} has risen above the reset threshold. For the APX803S00 this period is a minimum of 1ms while for other APX803S variants it is at least 140ms. The APX803S has an open-drain output stage.

Ensuring a Valid Reset Output Down to $V_{CC} = 0$

$\overline{\text{RESET}}$ is guaranteed to be a logic low for $V_{CC} > 1\text{V}$. Once V_{CC} exceeds the reset threshold, an internal timer keeps $\overline{\text{RESET}}$ low for the reset timeout period; after this interval, $\overline{\text{RESET}}$ goes high. If a brownout condition occurs (V_{CC} dips below the $\overline{\text{RESET}}$ reset threshold), $\overline{\text{RESET}}$ goes low. Any time V_{CC} goes below the reset threshold, the internal timer resets to zero, and $\overline{\text{RESET}}$ goes low. The internal timer starts after V_{CC} returns above the reset threshold, and $\overline{\text{RESET}}$ remains low for the reset timeout period.

When V_{CC} falls below 1V, the APX803S $\overline{\text{RESET}}$ output no longer sinks current — it becomes an open circuit. Therefore, high-impedance CMOS logic inputs connected to $\overline{\text{RESET}}$ can drift to undetermined voltages.

This presents no problem in most applications since most μP and other circuitry is inoperative with V_{CC} below 1V.

Interfacing to μP with Bidirectional RESET Pins

Since the RESET output on the APX803S is open drain, this device interfaces easily with $\mu\text{P}/\mu\text{C}$ that has bidirectional RESET pins, such as the Motorola 68HC11.

Connecting the μP supervisor's RESET output directly to the microcontroller's (μC 's) RESET pin with a single pull-up resistor allows either device to assert reset.

Supervising and Monitoring Multiple Supplies

Generally, the pull-up resistor connected to the APX803S will connect to the supply voltage that is being monitored at the IC's V_{CC} pin. However, some systems may use the APX803S open-drain output to level-shift from the monitored supply to reset the μP powered by a different supply voltage or monitor multiple supplies that will be fed into 1 $\mu\text{C}/\mu\text{P}$ reset input.

Functional Description (Cont.)

Selection of Voltage Divider Value (Take APX803S00-29SA-7 as example)

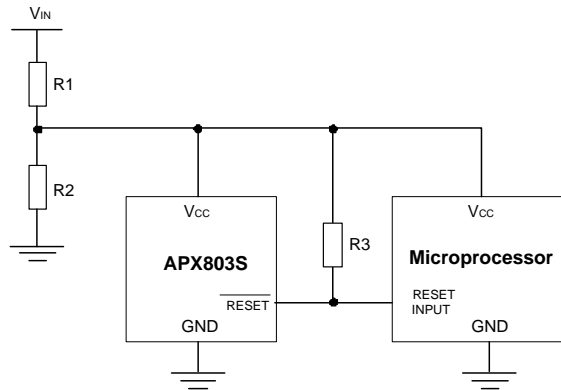

When \$V_{CC}\$ just rises up to the \$V_{TH}\$ value (2.93V in this case), the internal oscillator will start working, which may pull some considerable current from the source voltage, such as 60µA or so. Take above topology as real application example, below equation required to meet to make sure the IC boot up smoothly. Given \$V_{CC} = 13.2V\$ and \$R3 = 100k\Omega\$, an appropriate \$R1/R2\$ value combination would be \$R1 = 15.6k\Omega\$ and \$R2 = 7.3k\Omega\$.

$$V_{CC} = \frac{\frac{R2 \cdot R3 \cdot R_{IN}}{R2 \cdot R3 + R2 \cdot R_{IN} + R3 \cdot R_{IN}}}{\frac{R2 \cdot R3 \cdot R_{IN}}{R2 \cdot R3 + R2 \cdot R_{IN} + R3 \cdot R_{IN}} + R1} \times V_{IN}$$

Note: \$R_{IN}\$ is defined as equivalent input resistance of APX803S00-29, 51.4kΩ derived by 2.93V/57µA in this case.

Ordering Information

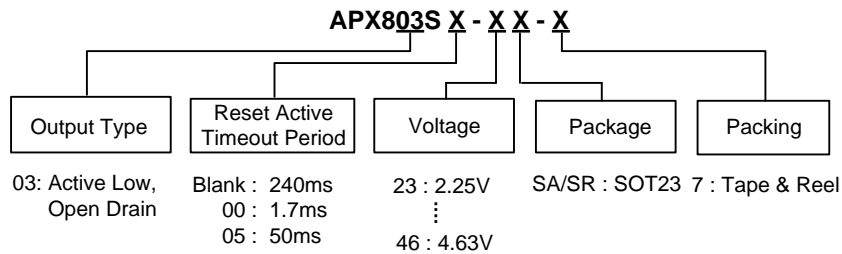

Part Number	Package Code	Packaging (Note 4)	7" Tape and Reel	
			Quantity	Part Number Suffix
APX803SXX-XXSA-7	SA	SOT23	3000/Tape & Reel	-7
APX803SXX-XXSR-7	SR	SOT23	3000/Tape & Reel	-7

Note: 4. Pad layout as shown in Diodes Incorporated's package outline PDFs, which can be found on our website at <http://www.diodes.com/package-outlines.html>.

Marking Information

(1) SOT23

(Top View)

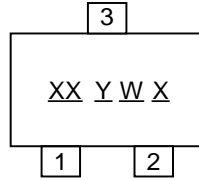

XX : Identification code

Y : Year 0~9

W : Week : A~Z : 1~26 week;
a~z : 27~52 week; z represents
52 and 53 week

X : Internal code

Device	Package	Identification Code
APX803S-46SA	SOT23	V3
APX803S-44SA	SOT23	V4
APX803S-40SA	SOT23	V5
APX803S-31SA	SOT23	V6
APX803S-29SA	SOT23	V7
APX803S-26SA	SOT23	V8
APX803S-23SA	SOT23	V9
APX803S-46SR	SOT23	S3
APX803S-44SR	SOT23	S4
APX803S-40SR	SOT23	S5
APX803S-31SR	SOT23	S6
APX803S-29SR	SOT23	S7
APX803S-26SR	SOT23	S8
APX803S-23SR	SOT23	S9
APX803S00-46SA	SOT23	VA
APX803S00-44SA	SOT23	VB
APX803S00-40SA	SOT23	VC
APX803S00-31SA	SOT23	VD
APX803S00-29SA	SOT23	VE
APX803S00-26SA	SOT23	VF
APX803S00-23SA	SOT23	VG
APX803S00-46SR	SOT23	VH
APX803S00-44SR	SOT23	VJ
APX803S00-40SR	SOT23	VK
APX803S00-31SR	SOT23	VM
APX803S00-29SR	SOT23	VS
APX803S00-26SR	SOT23	VT
APX803S00-23SR	SOT23	VU
APX803S05-46SA	SOT23	VV
APX803S05-44SA	SOT23	VW
APX803S05-40SA	SOT23	VX
APX803S05-31SA	SOT23	VY
APX803S05-29SA	SOT23	VZ
APX803S05-26SA	SOT23	WA
APX803S05-23SA	SOT23	WB
APX803S05-46SR	SOT23	WC
APX803S05-44SR	SOT23	WD
APX803S05-40SR	SOT23	WE
APX803S05-31SR	SOT23	WF
APX803S05-29SR	SOT23	WG
APX803S05-26SR	SOT23	WH
APX803S05-23SR	SOT23	WZ

NEW PRODUCT

Package Outline Dimensions

Please see <http://www.diodes.com/package-outlines.html> for the latest version.

SOT23

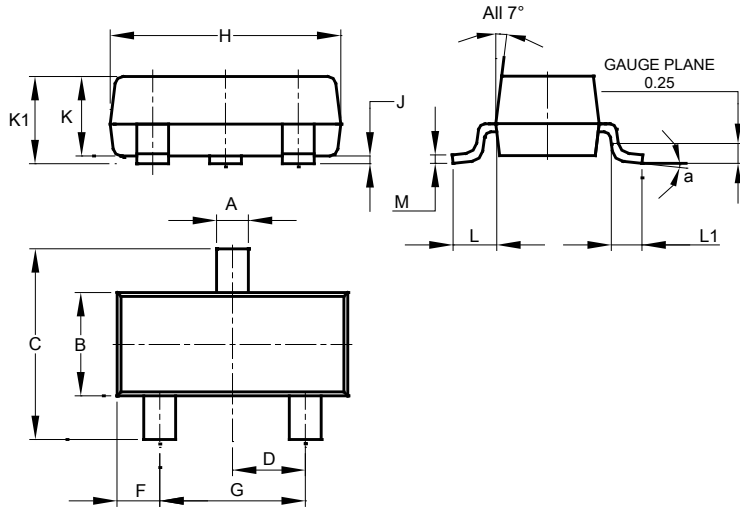

SOT23			
Dim	Min	Max	Typ
A	0.37	0.51	0.40
B	1.20	1.40	1.30
C	2.30	2.50	2.40
D	0.89	1.03	0.915
F	0.45	0.60	0.535
G	1.78	2.05	1.83
H	2.80	3.00	2.90
J	0.013	0.10	0.05
K	0.890	1.00	0.975
K1	0.903	1.10	1.025
L	0.45	0.61	0.55
L1	0.25	0.55	0.40
M	0.085	0.150	0.110
a	0°	8°	--
All Dimensions in mm			

NEW PRODUCT

Suggested Pad Layout

Please see <http://www.diodes.com/package-outlines.html> for the latest version.

SOT23

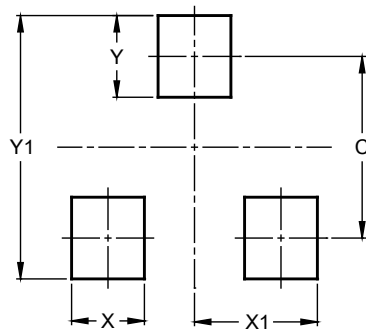

Dimensions	Value (in mm)
C	2.0
X	0.8
X1	1.35
Y	0.9
Y1	2.9

IMPORTANT NOTICE

DIODES INCORPORATED MAKES NO WARRANTY OF ANY KIND, EXPRESS OR IMPLIED, WITH REGARDS TO THIS DOCUMENT, INCLUDING, BUT NOT LIMITED TO, THE IMPLIED WARRANTIES OF MERCHANTABILITY AND FITNESS FOR A PARTICULAR PURPOSE (AND THEIR EQUIVALENTS UNDER THE LAWS OF ANY JURISDICTION).

Diodes Incorporated and its subsidiaries reserve the right to make modifications, enhancements, improvements, corrections or other changes without further notice to this document and any product described herein. Diodes Incorporated does not assume any liability arising out of the application or use of this document or any product described herein; neither does Diodes Incorporated convey any license under its patent or trademark rights, nor the rights of others. Any Customer or user of this document or products described herein in such applications shall assume all risks of such use and will agree to hold Diodes Incorporated and all the companies whose products are represented on Diodes Incorporated website, harmless against all damages.

Diodes Incorporated does not warrant or accept any liability whatsoever in respect of any products purchased through unauthorized sales channel. Should Customers purchase or use Diodes Incorporated products for any unintended or unauthorized application, Customers shall indemnify and hold Diodes Incorporated and its representatives harmless against all claims, damages, expenses, and attorney fees arising out of, directly or indirectly, any claim of personal injury or death associated with such unintended or unauthorized application.

Products described herein may be covered by one or more United States, international or foreign patents pending. Product names and markings noted herein may also be covered by one or more United States, international or foreign trademarks.

This document is written in English but may be translated into multiple languages for reference. Only the English version of this document is the final and determinative format released by Diodes Incorporated.

LIFE SUPPORT

Diodes Incorporated products are specifically not authorized for use as critical components in life support devices or systems without the express written approval of the Chief Executive Officer of Diodes Incorporated. As used herein:

A. Life support devices or systems are devices or systems which:

1. are intended to implant into the body, or
2. support or sustain life and whose failure to perform when properly used in accordance with instructions for use provided in the labeling can be reasonably expected to result in significant injury to the user.

B. A critical component is any component in a life support device or system whose failure to perform can be reasonably expected to cause the failure of the life support device or to affect its safety or effectiveness.

Customers represent that they have all necessary expertise in the safety and regulatory ramifications of their life support devices or systems, and acknowledge and agree that they are solely responsible for all legal, regulatory and safety-related requirements concerning their products and any use of Diodes Incorporated products in such safety-critical, life support devices or systems, notwithstanding any devices- or systems-related information or support that may be provided by Diodes Incorporated. Further, Customers must fully indemnify Diodes Incorporated and its representatives against any damages arising out of the use of Diodes Incorporated products in such safety-critical, life support devices or systems.

Copyright © 2017, Diodes Incorporated

www.diodes.com

X-ON Electronics

Largest Supplier of Electrical and Electronic Components

Click to view similar products for [Supervisory Circuits](#) category:

Click to view products by [Diodes Incorporated](#) manufacturer:

Other Similar products are found below :

[CAT853STBI-T3](#) [RT9818C-27GU3](#) [DS1232L](#) [NCV302HSN45T1G](#) [STM6710FWB7F](#) [PT7M6127NLTA3EX](#) [XC6118C25AGR-G](#)
[ISL88011IH526Z-TK](#) [ISL88013IH529Z-TK](#) [ISL88705IP846Z](#) [ISL88706IP831Z](#) [ISL88708IB844Z](#) [ISL88708IP831Z](#) [TCM811MERCTR](#)
[X40420S14-A](#) [X40421S14-C](#) [X40430S14-A](#) [X40430S14I-A](#) [X40430S14I-B](#) [X40431S14-A](#) [X40431S14-B](#) [X40431S14-C](#) [X40431S14I-A](#)
[X40431S14I-B](#) [X40431S14I-C](#) [X4043P-2.7](#) [X4043PI-2.7](#) [X4043S8-2.7T1](#) [X4043S8IZ-2.7](#) [X4043S8IZT1](#) [X4043S8T1](#) [X4045P](#) [X4045PI](#)
[X4045PI-2.7](#) [X4045S8-2.7T1](#) [X4045S8IZ](#) [X4045S8T1](#) [X4163P](#) [X4163P-2.7](#) [X4163PI](#) [X4163PI-2.7](#) [X4163S8](#) [X4165P](#) [X4165P-2.7](#)
[X4165PI](#) [X4165PI-2.7](#) [X4165S8I-2.7](#) [X4283S8I](#) [X4323S8-2.7](#) [X4323S8I-2.7](#)