

1A ULTRA LOW DROPOUT LINEAR REGULATOR

Description

The AZ2940 is a low dropout three-terminal regulator with a typical dropout of 280mV at 1A output current.

The AZ2940 provides current limit and thermal shutdown. On-chip thermal shutdown provides protection against any combination of high current and ambient temperature that would create excessive junction temperatures.

The AZ2940 has 1.2V, 1.8V, 2.5V, 3.3V and 5.0V versions.

The AZ2940 series is available in the industry standard TO-220-3, TO-220F-3, TO-263-3, TO-252-2 (3), TO-252-2 (4), TO-252-2 (5) and SOT-223 power packages. (Detailed information please refer to pages 13, 14)

Applications

- LCD TV
- Set Top Box
- LCD Monitor
- SMPS Post Regulator
- Laptop, Palmtop and Notebook
- Portable Instrumentation
- USB Power Supply

- Notes:
1. EU Directive 2002/95/EC (RoHS) & 2011/65/EU (RoHS 2) compliant. All applicable RoHS exemptions applied.
 2. See http://www.diodes.com/quality/lead_free.html for more information about Diodes Incorporated's definitions of Halogen- and Antimony-free, "Green" and Lead-free.
 3. Halogen- and Antimony-free "Green" products are defined as those which contain <900ppm bromine, <900ppm chlorine (<1500ppm total Br + Cl) and <1000ppm antimony compounds.

Pin Assignments

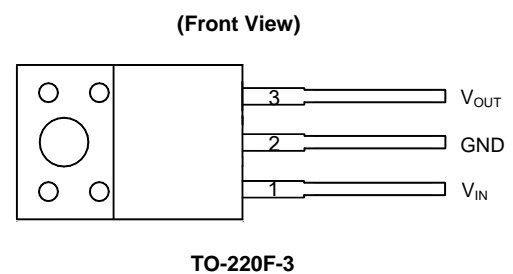
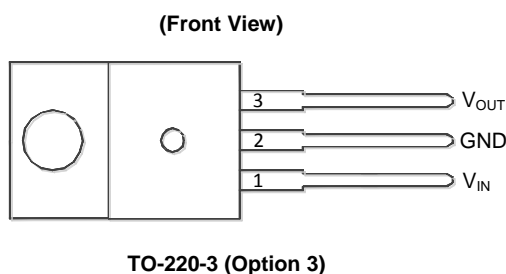
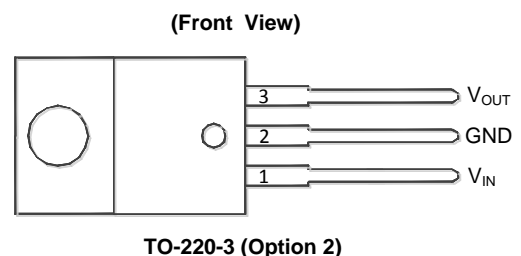
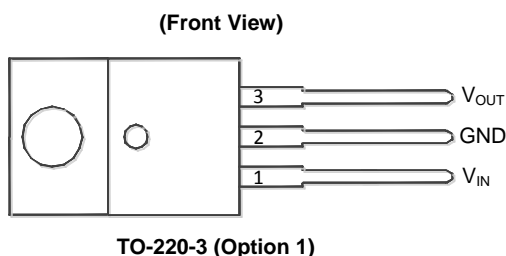

Pin Assignments (Cont.)

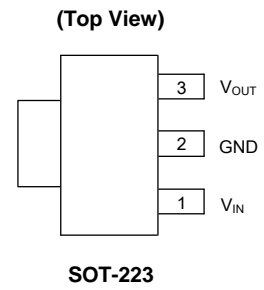
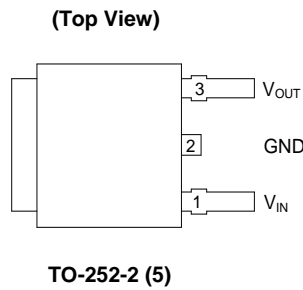
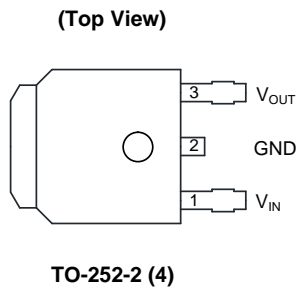
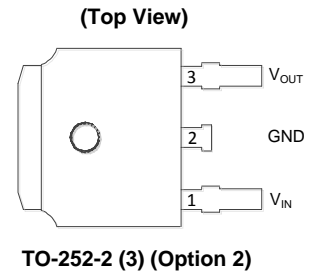
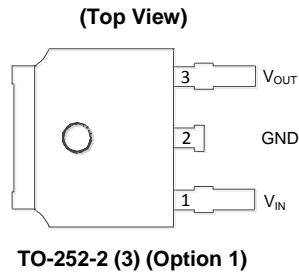
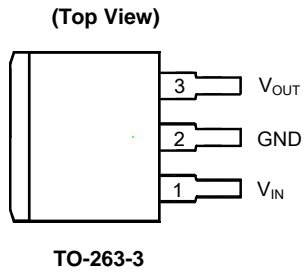

Typical Applications Circuit (Note 4)

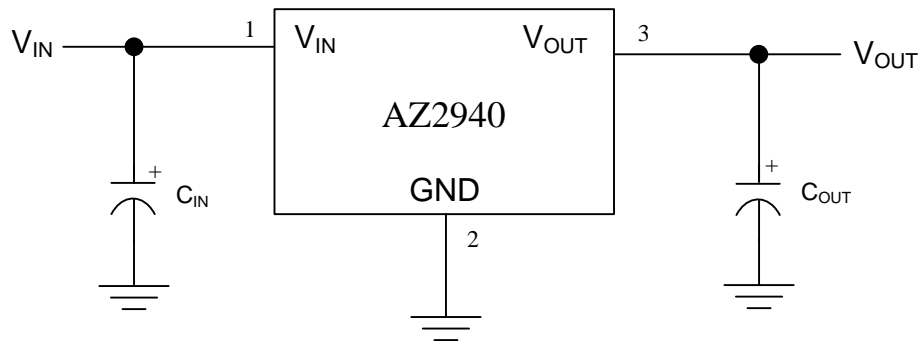

Note 4: C_{IN} is required if regulator is located far from power supply filter and is recommended to be 0.47μF or greater. To maintain stability, C_{OUT} is recommended to be 2.2μF or greater. The ESR of this capacitor is critical, please see curve.

Pin Description

Pin Number	Pin Name	Function
1	V _{IN}	Unregulated Input
2	GND	Ground pin. This pin and TAB are internally connected
3	V _{OUT}	Regulated Output

Functional Block Diagram

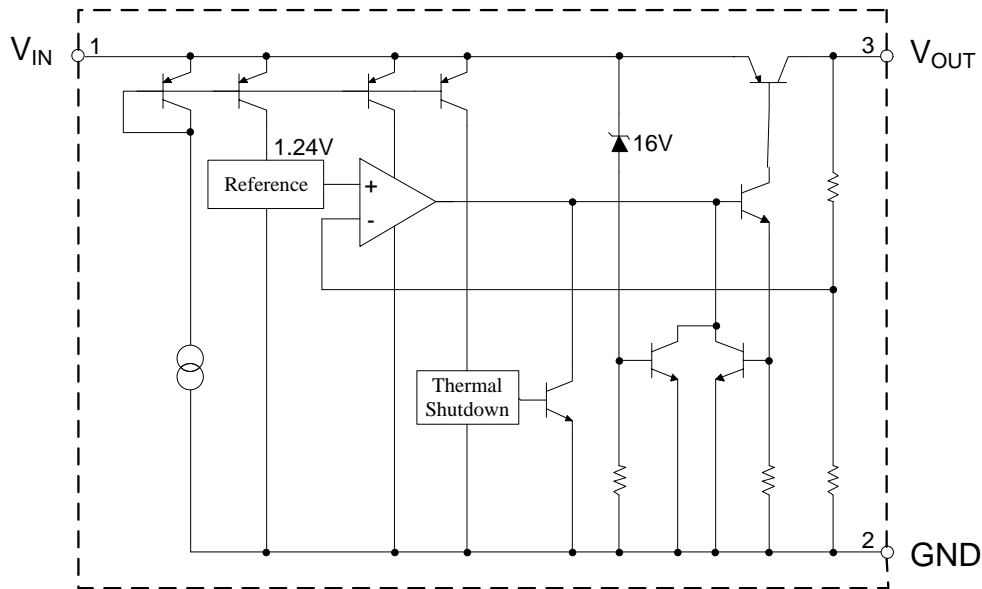

Absolute Maximum Ratings (Note 5)

Symbol	Parameter	Rating		Unit
V _{IN}	Input Voltage	16		V
T _J	Operating Junction Temperature	+150		°C
T _{STG}	Storage Temperature Range	-65 to +150		°C
T _{LEAD}	Lead Temperature (Soldering, 10sec)	+260		°C
θ _{JA}	Thermal Resistance (Junction to Ambient)	TO-220-3/TO-220F-3	60	°C/W
		TO-263-3	60	
		TO-252-2 (3)/(4)/(5)	100	
		SOT-223	120	
ESD	ESD (Human Body Model)	5000		V
ESD	ESD (Machine Model)	300		V

Note 5: Stresses greater than those listed under “Absolute Maximum Ratings” may cause permanent damage to the device. These are stress ratings only, and functional operation of the device at these or any other conditions beyond those indicated under “Recommended Operating Conditions” is not implied. Exposure to “Absolute Maximum Ratings” for extended periods may affect device reliability.

Recommended Operating Conditions

Symbol	Parameter	Min	Max	Unit
V _{IN}	Input Voltage	2.5	13.2	V
T _J	Operating Junction Temperature	-40	+125	°C

Electrical Characteristics

AZ2940-1.2 Electrical Characteristics

(Operating Conditions: $V_{IN} = 2.5V$, $I_{OUT} = 10mA$, $C_{IN} = 10\mu F$, $C_{OUT} = 10\mu F$, $T_J = +25^\circ C$, unless otherwise specified. The **Boldface** applies over $-40^\circ C$ to $+125^\circ C$)

Symbol	Parameter	Condition	Min	Typ	Max	Unit	
V_{OUT}	Output Voltage	$I_{OUT} = 10mA$	1.188	1.2	1.212	V	
		$10mA \leq I_{OUT} \leq 1A$, $2.5V \leq V_{IN} \leq 13.2V$	1.176	1.2	1.224	V	
V_{RLINE}	Line Regulation	$I_{OUT} = 10mA$, $2.5V \leq V_{IN} \leq 13.2V$	–	3.6	18	mV	
V_{RLOAD}	Load Regulation	$V_{IN} = 2.5V$, $10mA \leq I_{OUT} \leq 1A$	–	5.4	27	mV	
$\Delta V_{OUT}/\Delta T$	Output Voltage Temperature Coefficient	$I_{OUT} = 10mA$	–	–	180	$\mu V/^\circ C$	
I_{GND}	Ground Current	$V_{IN} = 2.5V$	$I_{OUT} = 750mA$	–	12	25	mA
			$I_{OUT} = 1A$	–	18	–	mA
I_{SC}	Short Circuit Current	$V_{OUT} = 0V$ (Note 6)	1.5	2.2	–	A	
$I_{LOAD(MIN)}$	Minimum Load Current	–	–	1	5	mA	
–	Output Noise Voltage (rms)	10Hz to 100kHz, $I_{OUT} = 100mA$, $C_{OUT} = 10\mu F$	–	400	–	μV	
θ_{JC}	Thermal Resistance	TO-252-2 (3)/(4)/(5)	–	7.8	–	$^\circ C/W$	
		SOT-223	–	29.7	–		

Note 6: $V_{IN} = V_{OUT(NOMINAL)} + 1V$.

Electrical Characteristics (Cont.)

AZ2940-1.8 Electrical Characteristics

(Operating Conditions: $V_{IN} = 2.8V$, $I_{OUT} = 10mA$, $C_{IN} = 10\mu F$, $C_{OUT} = 10\mu F$, $T_J = +25^\circ C$, unless otherwise specified. The **Boldface** applies over $-40^\circ C$ to $+125^\circ C$)

Symbol	Parameter	Condition	Min	Typ	Max	Unit	
V_{OUT}	Output Voltage	$I_{OUT} = 10mA$	1.782	1.8	1.818	V	
		$10mA \leq I_{OUT} \leq 1A$, $2.8V \leq V_{IN} \leq 13.2V$	1.764	1.8	1.836	V	
V_{RLINE}	Line Regulation	$I_{OUT} = 10mA$, $2.8V \leq V_{IN} \leq 13.2V$	–	3.6	18	mV	
V_{RLOAD}	Load Regulation	$V_{IN} = 2.8V$, $10mA \leq I_{OUT} \leq 1A$	–	5.4	27	mV	
$\Delta V_{OUT}/\Delta T$	Output Voltage Temperature Coefficient	$I_{OUT} = 10mA$	–	36	180	$\mu V/^\circ C$	
V_{DROP}	Dropout Voltage (Note 7)	$\Delta V_{OUT} = 1\%$	$I_{OUT} = 100mA$	–	290	500	mV
			$I_{OUT} = 1A$	–	330	750	mV
I_{GND}	Ground Current	$V_{IN} = 2.8V$	$I_{OUT} = 750mA$	–	12	25	mA
			$I_{OUT} = 1A$	–	18	–	mA
I_{SC}	Short Circuit Current	$V_{OUT} = 0V$ (Note 6)	1.5	2.2	–	A	
$I_{LOAD(MIN)}$	Minimum Load Current	–	–	1	5	mA	
–	Output Noise Voltage (rms)	10Hz to 100kHz, $I_{OUT} = 100mA$, $C_{OUT} = 10\mu F$	–	400	–	μV	
θ_{JC}	Thermal Resistance	TO-252-2 (3)/(4)/(5)	–	7.8	–	$^\circ C/W$	
		SOT-223	–	29.7	–		

Notes: 6. $V_{IN} = V_{OUT(NOMINAL)} + 1V$.

7. Dropout voltage is defined as the input-to-output differential when the output voltage drops to 99% of its nominal value which is measured at $V_{OUT} + 1V$ applied to V_{IN} . In application, V_{IN} should be no less than 2.5V.

Electrical Characteristics (Cont.)

AZ2940-2.5 Electrical Characteristics

(Operating Conditions: $V_{IN} = 3.5V$, $I_{OUT} = 10mA$, $C_{IN} = 10\mu F$, $C_{OUT} = 10\mu F$, $T_J = +25^\circ C$, unless otherwise specified. The **Boldface** applies over -40°C to +125°C)

Symbol	Parameter	Condition	Min	Typ	Max	Unit	
V_{OUT}	Output Voltage	$I_{OUT} = 10mA$	2.475	2.5	2.525	V	
		$10mA \leq I_{OUT} \leq 1A$, $3.5V \leq V_{IN} \leq 13.2V$	2.45	2.5	2.55	V	
V_{RLINE}	Line Regulation	$I_{OUT} = 10mA$, $3.5V \leq V_{IN} \leq 13.2V$	-	5.0	25	mV	
V_{RLOAD}	Load Regulation	$V_{IN} = 3.5V$, $10mA \leq I_{OUT} \leq 1A$	-	7.5	37.5	mV	
$\Delta V_{OUT}/\Delta T$	Output Voltage Temperature Coefficient	$I_{OUT} = 10mA$	-	50	250	$\mu V/^\circ C$	
V_{DROP}	Dropout Voltage (Note 8)	$\Delta V_{OUT} = 1\%$	$I_{OUT} = 100mA$	-	70	200	mV
			$I_{OUT} = 1A$	-	280	550	mV
I_{GND}	Ground Current	$V_{IN} = 3.5V$	$I_{OUT} = 750mA$	-	12	25	mA
			$I_{OUT} = 1A$	-	18	-	mA
I_{SC}	Short Circuit Current	$V_{OUT} = 0V$ (Note 6)	1.5	2.2	-	A	
$I_{LOAD(MIN)}$	Minimum Load Current	-	-	1	5	mA	
-	Output Noise Voltage (rms)	10Hz to 100kHz, $I_{OUT} = 100mA$, $C_{OUT} = 10\mu F$	-	400	-	μV	
θ_{JC}	Thermal Resistance	TO-252-2 (3)/(4)/(5)	-	7.8	-	$^\circ C/W$	
		SOT-223	-	29.7	-		

Notes: 6. $V_{IN} = V_{OUT(NOMINAL)} + 1V$.

8. Dropout voltage is defined as the input-to-output differential when the output voltage drops to 99% of its nominal value which is measured at $V_{OUT} + 1V$ applied to V_{IN} .

Electrical Characteristics (Cont.)

AZ2940-3.3 Electrical Characteristics

(Operating Conditions: $V_{IN} = 4.3V$, $I_{OUT} = 10mA$, $C_{IN} = 10\mu F$, $C_{OUT} = 10\mu F$, $T_J = +25^\circ C$, unless otherwise specified. The **Boldface** applies over $-40^\circ C$ to $+125^\circ C$)

Symbol	Parameter	Condition	Min	Typ	Max	Unit	
V_{OUT}	Output Voltage	$I_{OUT} = 10mA$	3.27	3.3	3.33	V	
		$10mA \leq I_{OUT} \leq 1A$, $4.3V \leq V_{IN} \leq 13.2V$	3.23	3.3	3.37	V	
V_{RLINE}	Line Regulation	$I_{OUT} = 10mA$, $4.3V \leq V_{IN} \leq 13.2V$	–	6.6	33	mV	
V_{RLOAD}	Load Regulation	$V_{IN} = 4.3V$, $10mA \leq I_{OUT} \leq 1A$	–	9.9	50	mV	
$\Delta V_{OUT}/\Delta T$	Output Voltage Temperature Coefficient	$I_{OUT} = 10mA$	–	66	330	$\mu V/^\circ C$	
V_{DROP}	Dropout Voltage (Note 8)	$\Delta V_{OUT} = 1\%$	$I_{OUT} = 100mA$	–	70	200	mV
			$I_{OUT} = 1A$	–	280	550	mV
I_{GND}	Ground Current	$V_{IN} = 4.3V$	$I_{OUT} = 750mA$	–	12	25	mA
			$I_{OUT} = 1A$	–	18	–	mA
I_{SC}	Short Circuit Current	$V_{OUT} = 0V$ (Note 6)	1.5	2.2	–	A	
$I_{LOAD(MIN)}$	Minimum Load Current	–	–	1	5	mA	
–	Output Noise Voltage (rms)	10Hz to 100kHz, $I_{OUT} = 100mA$, $C_{OUT} = 10\mu F$	–	400	–	μV	
θ_{JC}	Thermal Resistance	TO-220-3	–	4.4	–	$^\circ C/W$	
		TO-263-3	–	4.4	–		
		TO-252-2 (3)/(4)/(5)	–	7.8	–		
		SOT-223	–	29.7	–		

Notes: 6. $V_{IN} = V_{OUT(NOMINAL)} + 1V$.

8. Dropout voltage is defined as the input-to-output differential when the output voltage drops to 99% of its nominal value which is measured at $V_{OUT} + 1V$ applied to V_{IN} .

Electrical Characteristics (Cont.)

AZ2940-5.0 Electrical Characteristics

(Operating Conditions: $V_{IN} = 6V$, $I_{OUT} = 10mA$, $C_{IN} = 10\mu F$, $C_{OUT} = 10\mu F$, $T_J = +25^\circ C$, unless otherwise specified. The **Boldface** applies over $-40^\circ C$ to $+125^\circ C$)

Symbol	Parameter	Condition	Min	Typ	Max	Unit	
V_{OUT}	Output Voltage	$I_{OUT} = 10mA$	4.95	5.0	5.05	V	
		$10mA \leq I_{OUT} \leq 1A$, $6V \leq V_{IN} \leq 13.2V$	4.90	5.0	5.10	V	
V_{RLINE}	Line Regulation	$I_{OUT} = 10mA$, $6V \leq V_{IN} \leq 13.2V$	–	10	50	mV	
V_{RLOAD}	Load Regulation	$V_{IN} = 6V$, $10mA \leq I_{OUT} \leq 1A$	–	15	75	mV	
$\Delta V_{OUT}/\Delta T$	Output Voltage Temperature Coefficient	$I_{OUT} = 10mA$	–	100	500	$\mu V/^\circ C$	
V_{DROP}	Dropout Voltage (Note 8)	$\Delta V_{OUT} = 1\%$	$I_{OUT} = 100mA$	–	70	200	mV
			$I_{OUT} = 1A$	–	280	550	mV
I_{GND}	Ground Current	$V_{IN} = 6V$	$I_{OUT} = 750mA$	–	12	25	mA
			$I_{OUT} = 1A$	–	18	–	mA
I_{SC}	Short Circuit Current	$V_{OUT} = 0V$ (Note 6)	1.5	2.2	–	A	
$I_{LOAD(MIN)}$	Minimum Load Current	–	–	1	5	mA	
–	Output Noise Voltage (rms)	10Hz to 100kHz, $I_{OUT} = 100mA$, $C_{OUT} = 10\mu F$	–	400	–	μV	
θ_{JC}	Thermal Resistance	TO-220-3/TO-220F-3	–	4.4	–	$^\circ C/W$	
		TO-263-3	–	4.4	–		
		TO-252-2 (3)/(4)/(5)	–	7.8	–		
		SOT-223	–	29.7	–		

Notes: 6. $V_{IN} = V_{OUT(NOMINAL)} + 1V$.

8. Dropout voltage is defined as the input-to-output differential when the output voltage drops to 99% of its nominal value which is measured at $V_{OUT} + 1V$ applied to V_{IN} .

Performance Characteristics

Line Regulation

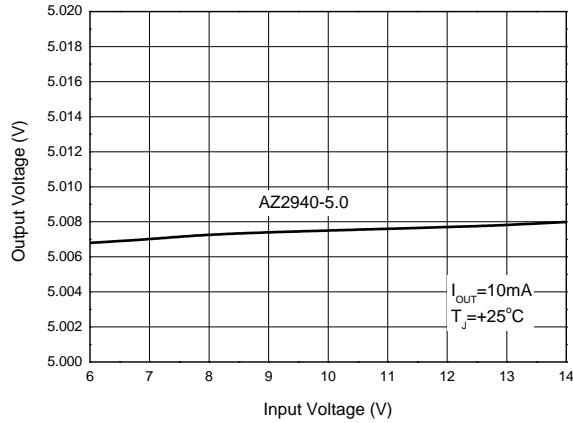

Load Regulation

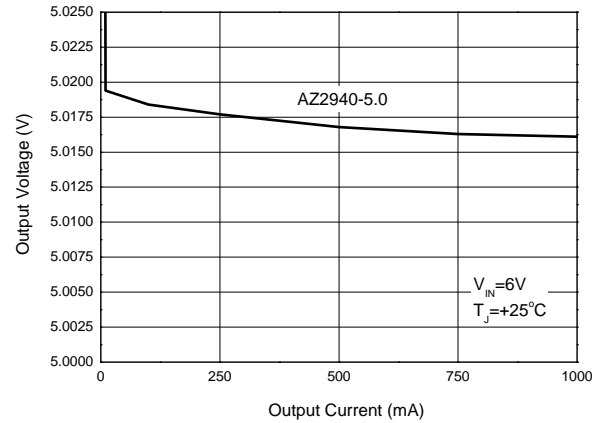

Ground Current vs. Output Current

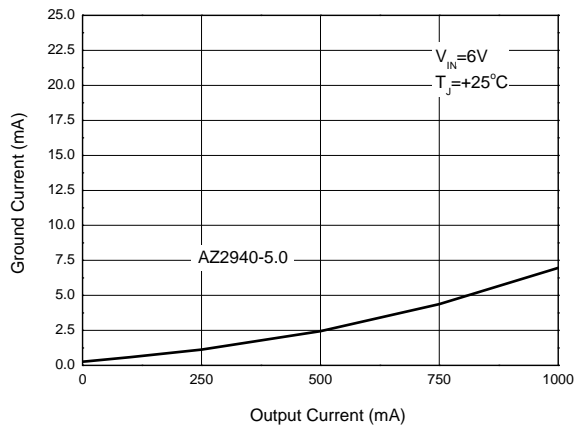

Ground Current vs. Input Voltage

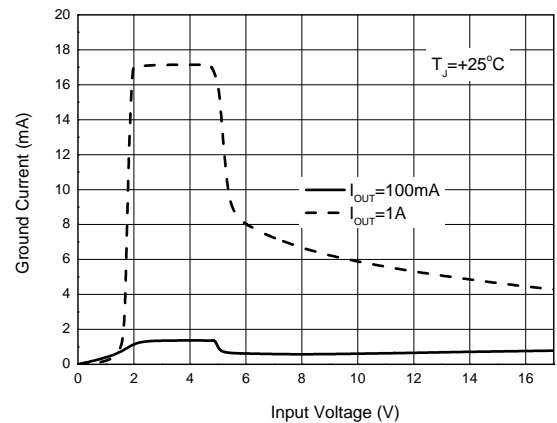

Dropout Voltage vs. Output Current

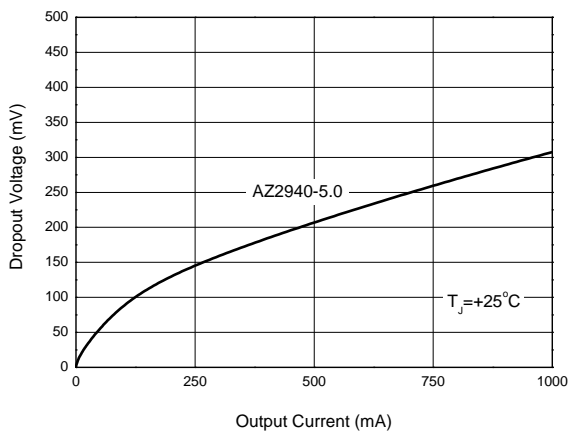

Ground Current vs. Junction Temperature

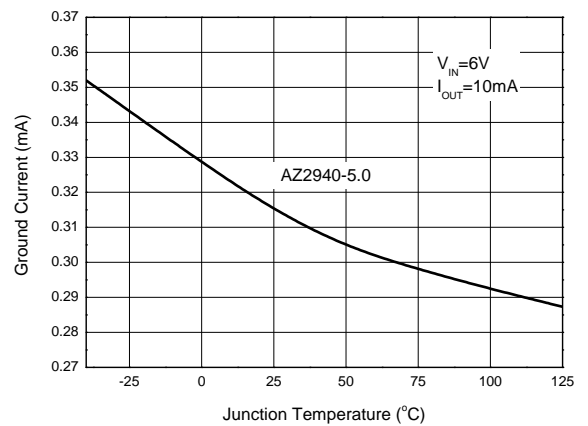

Performance Characteristics (Cont.)

Ground Current vs. Junction Temperature

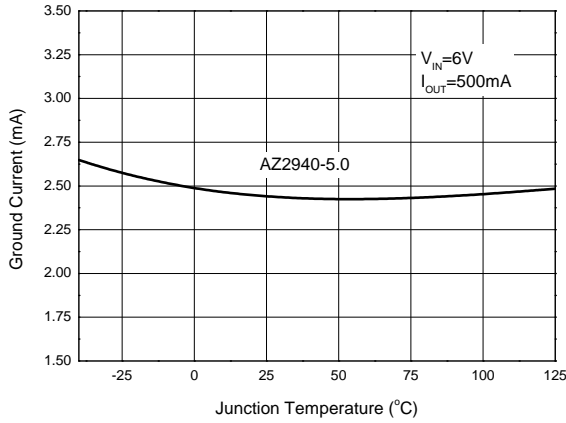

Ground Current vs. Junction Temperature

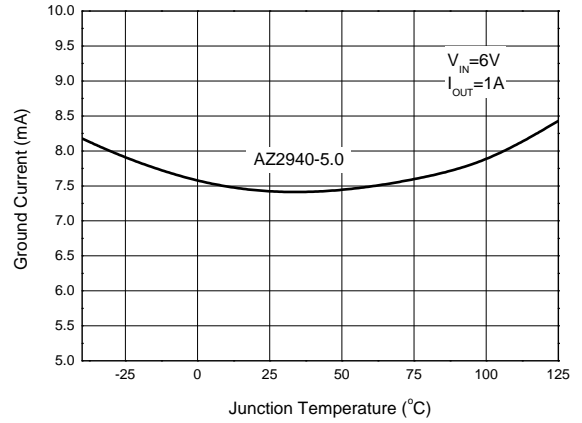

Dropout Voltage vs. Junction Temperature

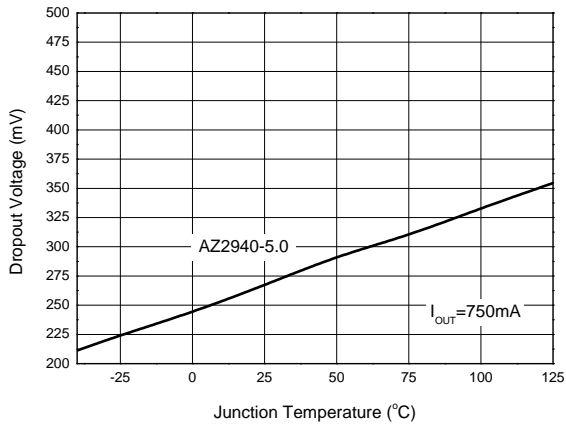

Dropout Voltage vs. Junction Temperature

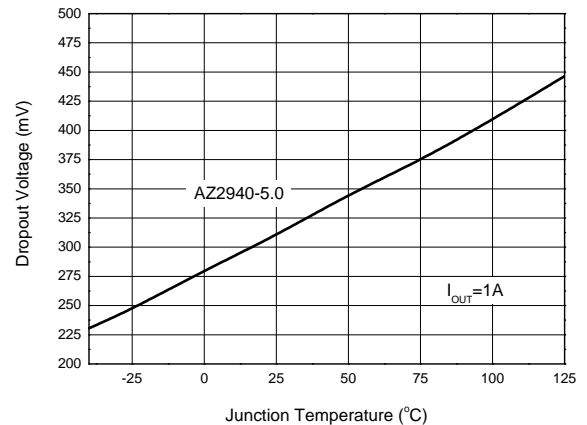

Output Voltage vs. Junction Temperature

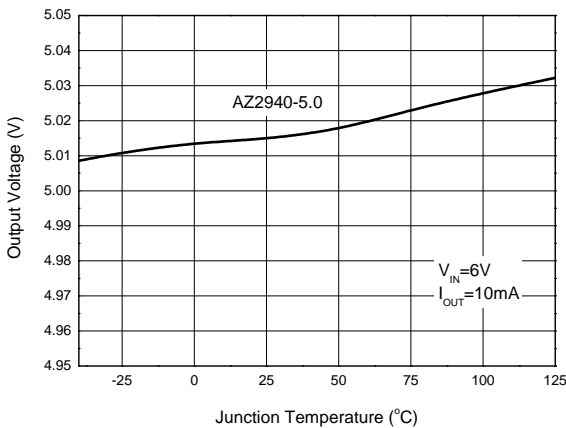

Output Capacitor ESR vs. Output Current

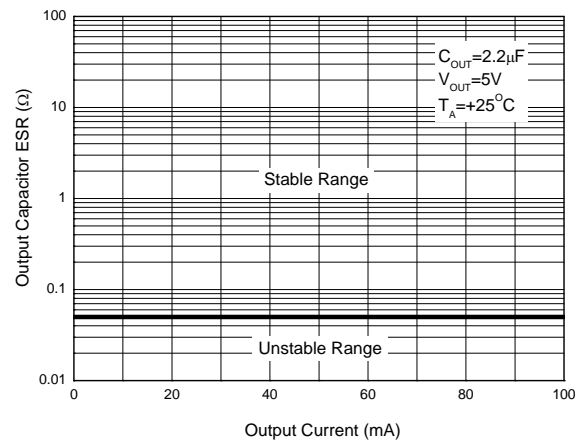

Performance Characteristics (Cont.)

Output Capacitor ESR vs. Output Current

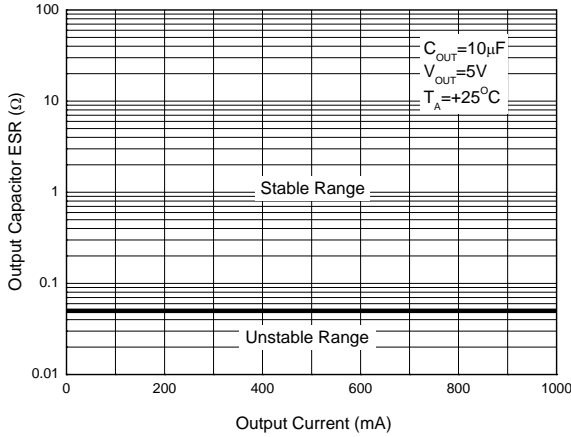

Load Transient

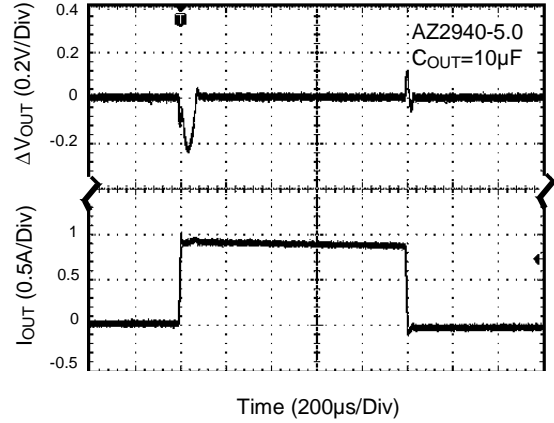

Load Transient

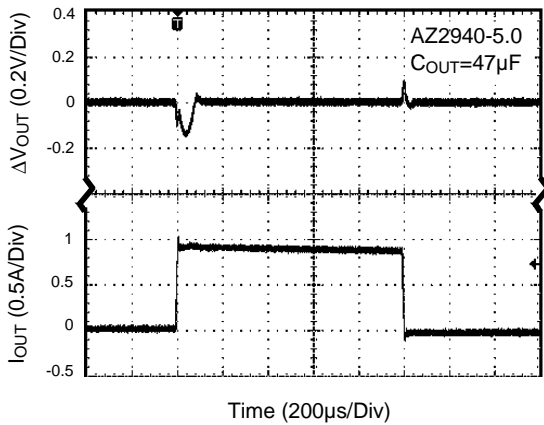

Line Transient

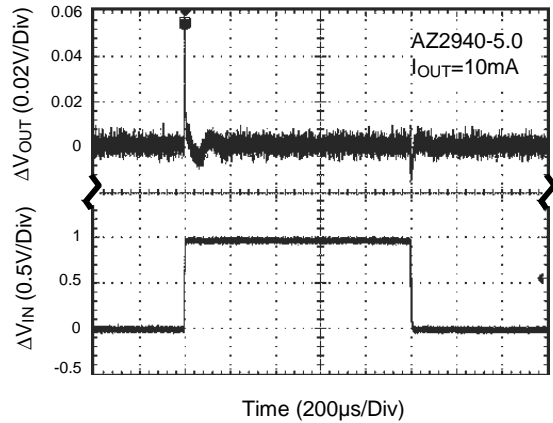

Power Dissipation vs. Case Temperature

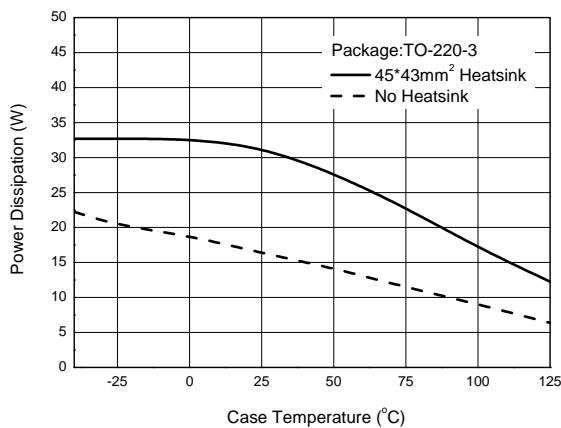

Power Dissipation vs. Case Temperature

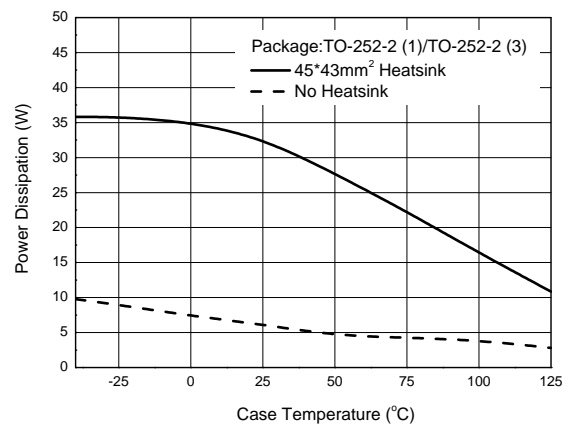

Performance Characteristics (Cont.)

Power Dissipation vs. Case Temperature

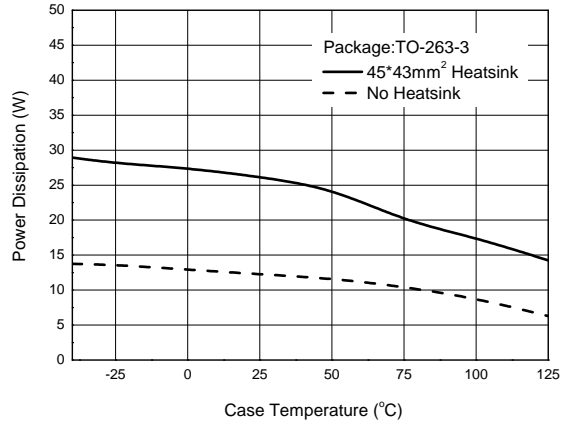

Ordering Information

AZ2940 XX - XX XX XX

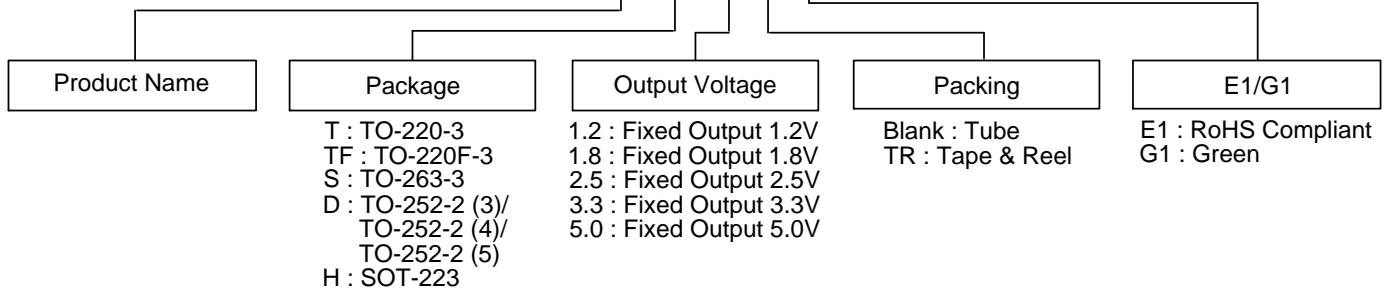

Package	Temperature Range	Part Number		Marking ID		Packing
		RoHS Compliant	Green	RoHS Compliant	Green	
TO-220-3	-40 to +125°C	AZ2940T-3.3E1	AZ2940T-3.3G1	AZ2940T-3.3E1	AZ2940T-3.3G1	1000/Tube
		AZ2940T-5.0E1	AZ2940T-5.0G1	AZ2940T-5.0E1	AZ2940T-5.0G1	1000/Tube
TO-220F-3	-40 to +125°C	-	AZ2940TF-5.0G1	-	AZ2940TF-5.0G1	1000/Tube
TO-263-3	-40 to +125°C	AZ2940S-3.3E1	AZ2940S-3.3G1	AZ2940S-3.3E1	AZ2940S-3.3G1	1000/Tube
		AZ2940S-3.3TRE1	AZ2940S-3.3TRG1	AZ2940S-3.3E1	AZ2940S-3.3G1	2500/Tape & Reel
		AZ2940S-5.0E1	AZ2940S-5.0G1	AZ2940S-5.0E1	AZ2940S-5.0G1	1000/Tube
		AZ2940S-5.0TRE1	AZ2940S-5.0TRG1	AZ2940S-5.0E1	AZ2940S-5.0G1	2500/Tape & Reel
TO-252-2 (3)/ TO-252-2 (4)/ TO-252-2(5)	-40 to +125°C	-	AZ2940D-1.2G1	-	AZ2940D-1.2G1	1000/Tube
		-	AZ2940D-1.2TRG1	-	AZ2940D-1.2G1	2500/Tape & Reel
		AZ2940D-1.8E1	AZ2940D-1.8G1	AZ2940D-1.8E1	AZ2940D-1.8G1	1000/Tube
		AZ2940D-1.8TRE1	AZ2940D-1.8TRG1	AZ2940D-1.8E1	AZ2940D-1.8G1	2500/Tape & Reel
		AZ2940D-2.5E1	AZ2940D-2.5G1	AZ2940D-2.5E1	AZ2940D-2.5G1	1000/Tube
		AZ2940D-2.5TRE1	AZ2940D-2.5TRG1	AZ2940D-2.5E1	AZ2940D-2.5G1	2500/Tape & Reel
		AZ2940D-3.3E1	AZ2940D-3.3G1	AZ2940D-3.3E1	AZ2940D-3.3G1	1000/Tube
		AZ2940D-3.3TRE1	AZ2940D-3.3TRG1	AZ2940D-3.3E1	AZ2940D-3.3G1	2500/Tape & Reel
		AZ2940D-5.0E1	AZ2940D-5.0G1	AZ2940D-5.0E1	AZ2940D-5.0G1	1000/Tube
		AZ2940D-5.0TRE1	AZ2940D-5.0TRG1	AZ2940D-5.0E1	AZ2940D-5.0G1	2500/Tape & Reel

Ordering Information (Cont.)



Package	Temperature Range	Part Number		Marking ID		Packing
		RoHS Compliant	Green	RoHS Compliant	Green	
SOT-223	-40 to +125°C	-	AZ2940H-1.2TRG1	-	GH12B	2500/Tape & Reel
		-	AZ2940H-1.8TRG1	-	GH12F	2500/Tape & Reel
		-	AZ2940H-2.5TRG1	-	GH12G	2500/Tape & Reel
		-	AZ2940H-3.3TRG1	-	GH12H	2500/Tape & Reel
		-	AZ2940H-5.0TRG1	-	GH12J	2500/Tape & Reel

Marking Information

(1) TO-220-3

(Front View)

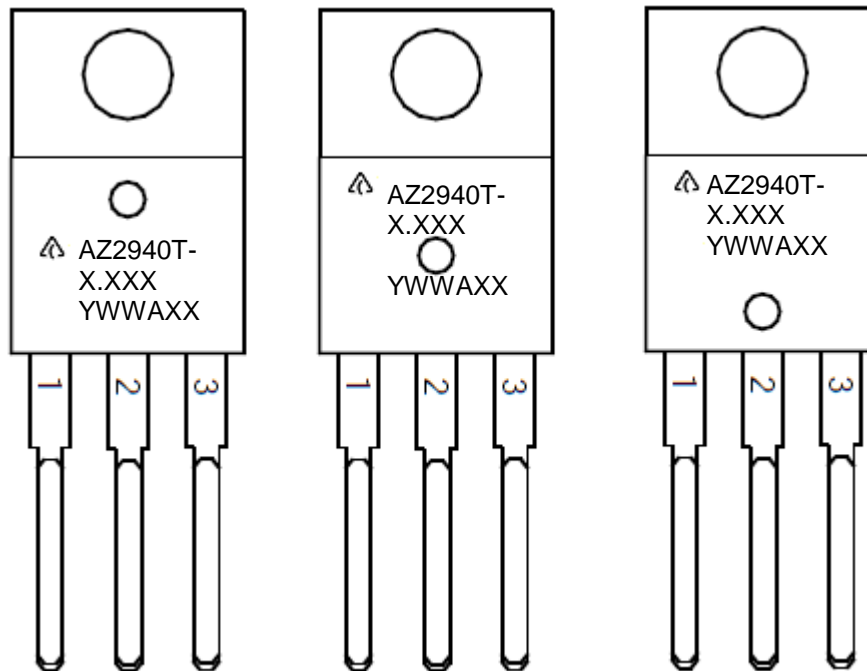

First and Second Lines: Logo and Marking ID
(See Ordering Information)
Third Line: Date Code
Y: Year
WW: Work Week of Molding
A: Assembly House Code
XX: Internal Code

Marking Information (Cont.)

(2) TO-220F-3

(Front View)

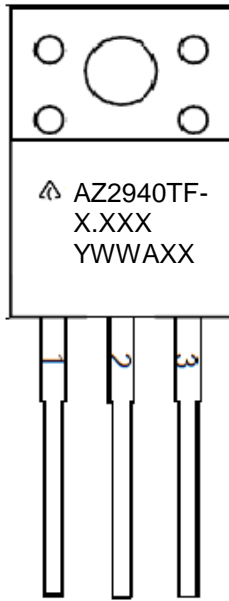

First and Second Lines: Logo and Marking ID
(See Ordering Information)
Third Line: Date Code
Y: Year
WW: Work Week of Molding
A: Assembly House Code
XX: Internal Code

(3) TO-252-2(3)(4)(5)

(Top View)

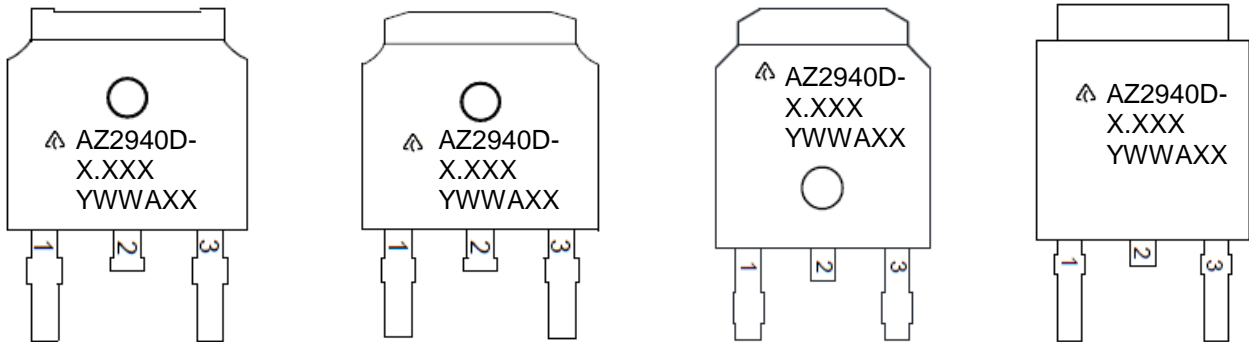

First and Second Lines: Logo and Marking ID
(See Ordering Information)
Third Line: Date Code
Y: Year
WW: Work Week of Molding
A: Assembly House Code
XX: Internal Code

Marking Information (Cont.)

(4) TO-263-3

(Top View)

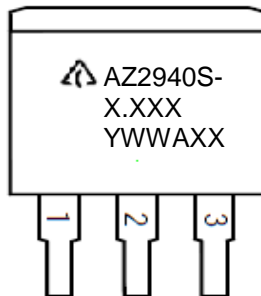

First and Second Lines: Logo and Marking ID
(See Ordering Information)
Third Line: Date Code
Y: Year
WW: Work Week of Molding
A: Assembly House Code
XX: Internal Code

(5) SOT-223

(Top View)



First Line: Logo and Marking ID
(See Ordering Information)
Second Line: Date Code
Y: Year
WW: Work Week of Molding
A: Assembly House Code
XX: Internal Code

Package Outline Dimensions (All dimensions in mm(inch).)

(1) Package Type: TO-220-3

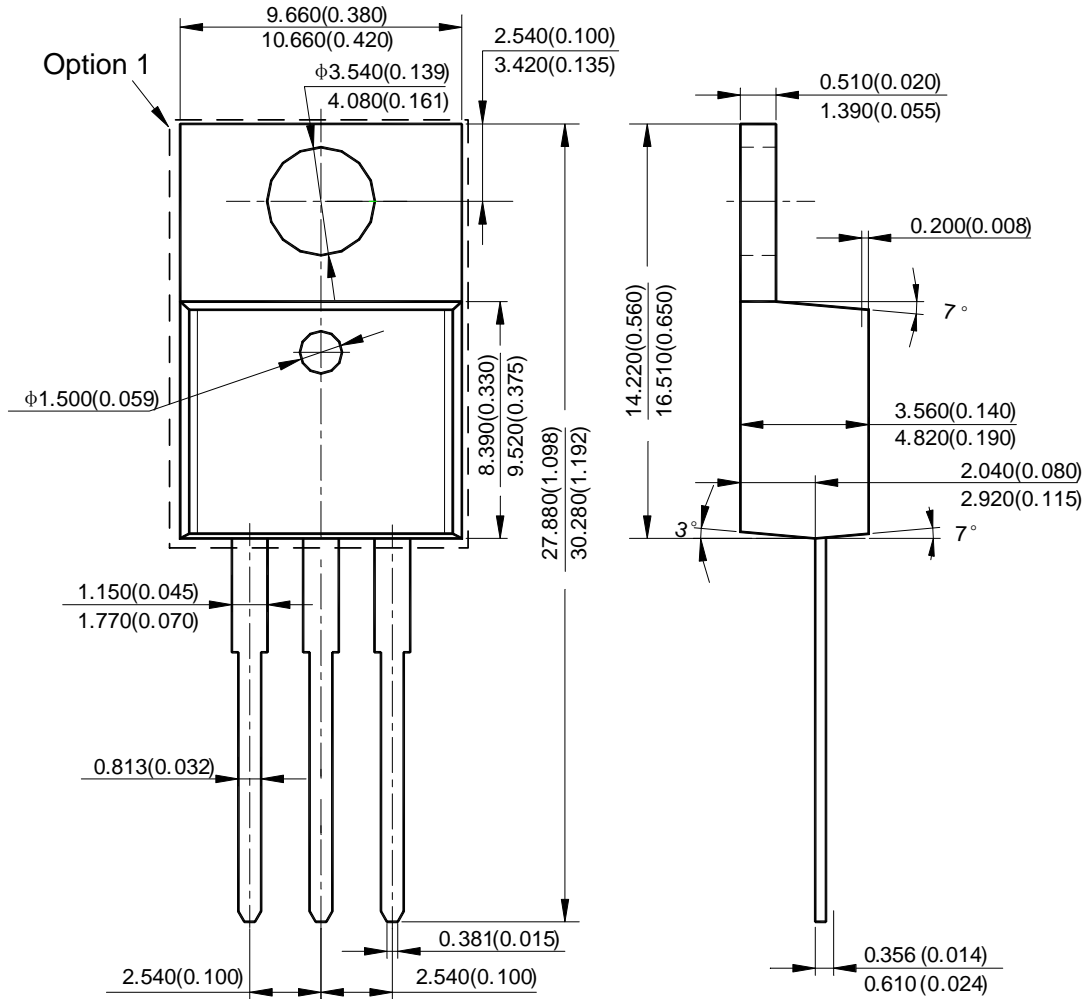

Option 2

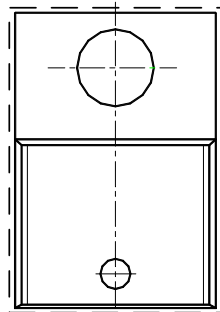

Option 3

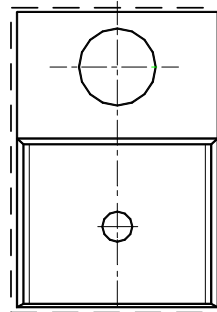

Package Outline Dimensions (Cont. All dimensions in mm(inch).)

(2) Package Type: TO-220F-3

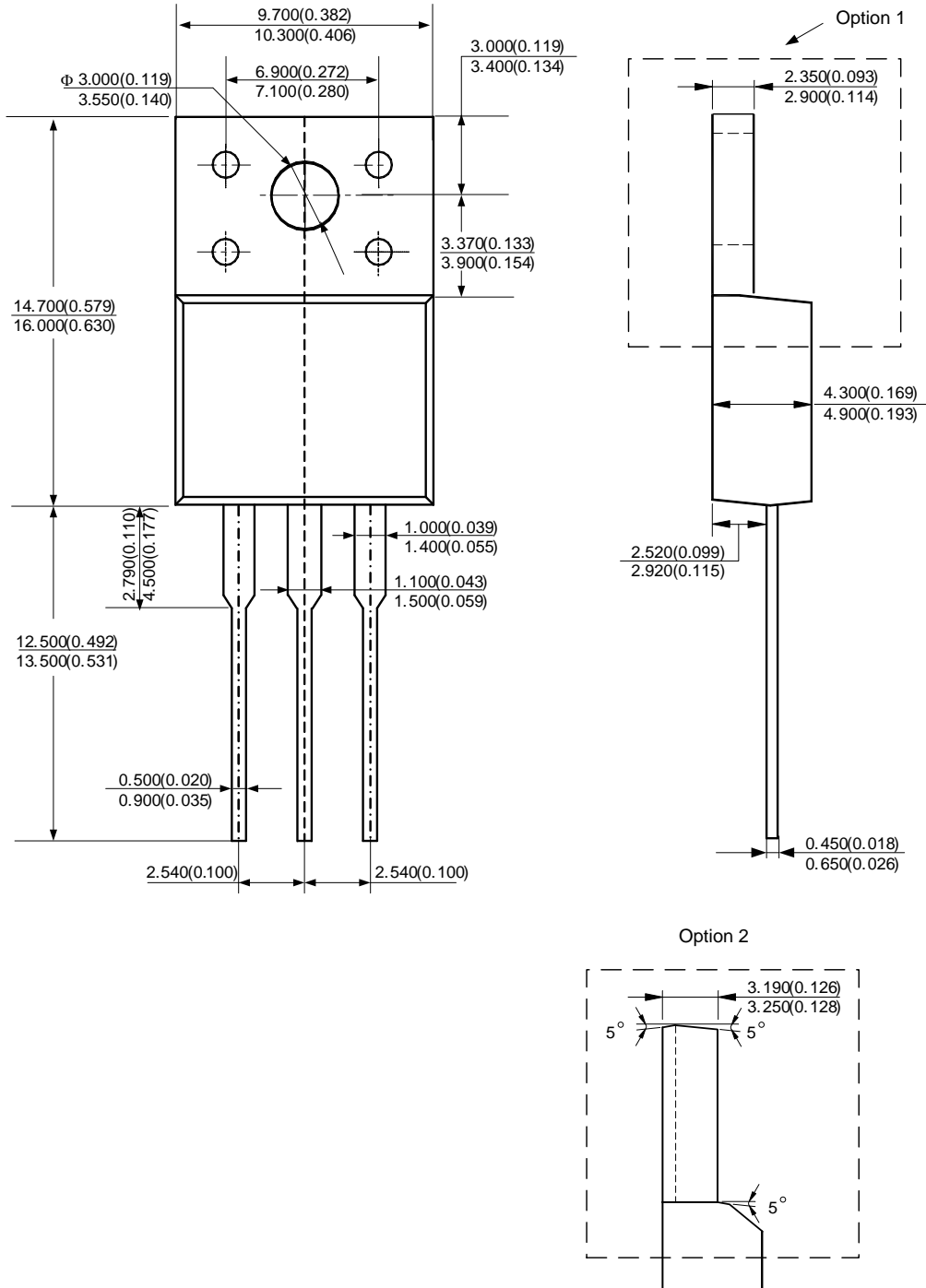

Package Outline Dimensions (Cont. All dimensions in mm(inch).)

(3) Package Type: TO-263-3

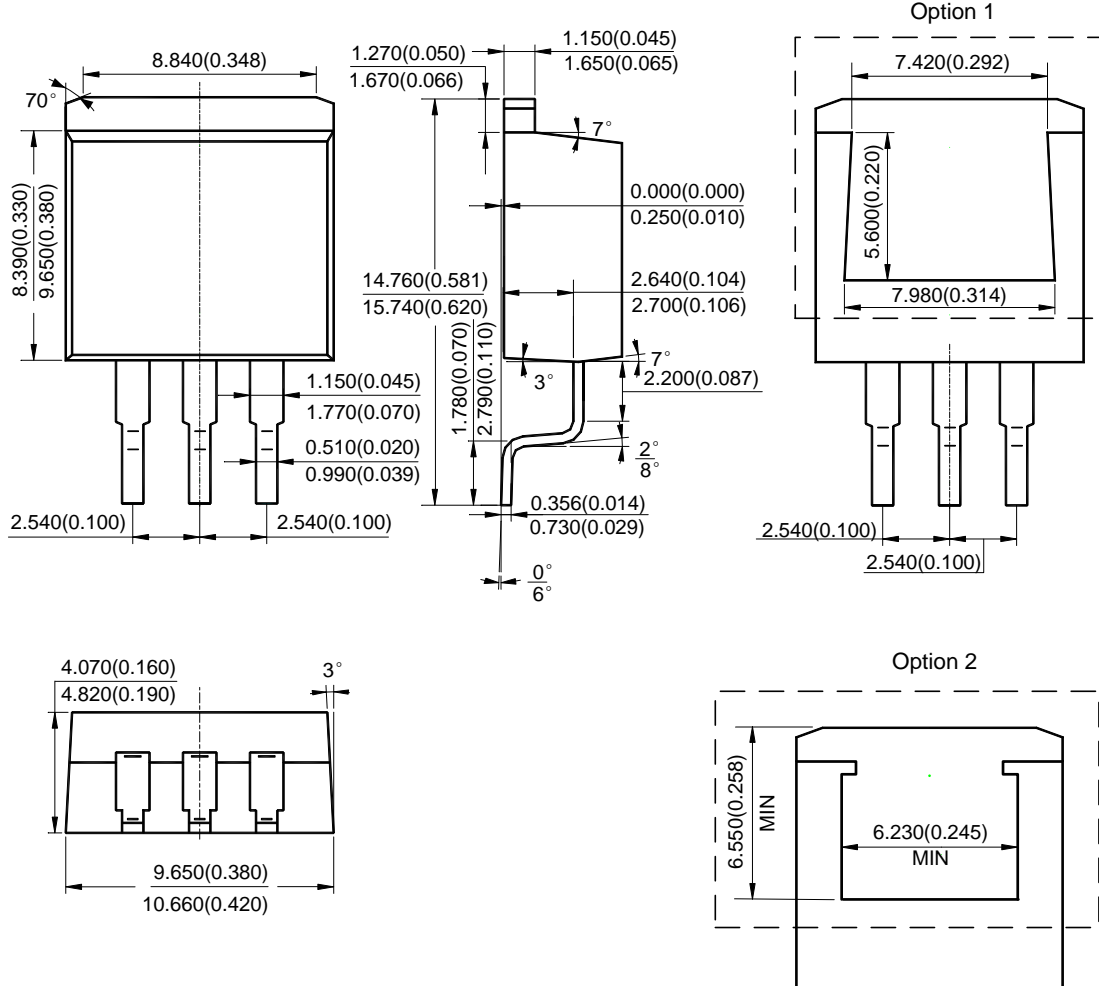

Package Outline Dimensions (Cont. All dimensions in mm(inch).)

(4) Package Type: SOT-223

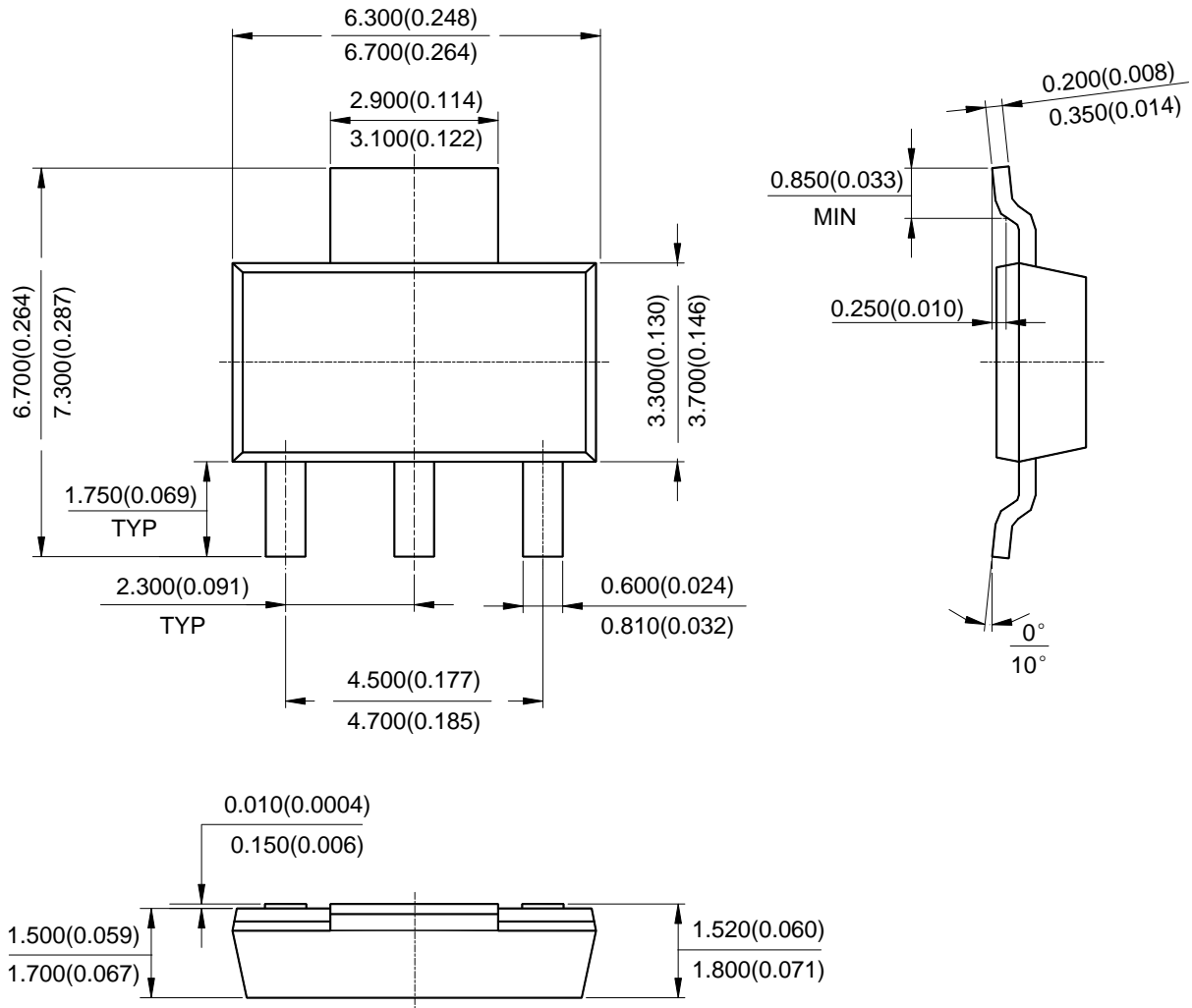

Package Outline Dimensions (Cont. All dimensions in mm(inch).)

(5) Package Type: TO-252-2 (3)

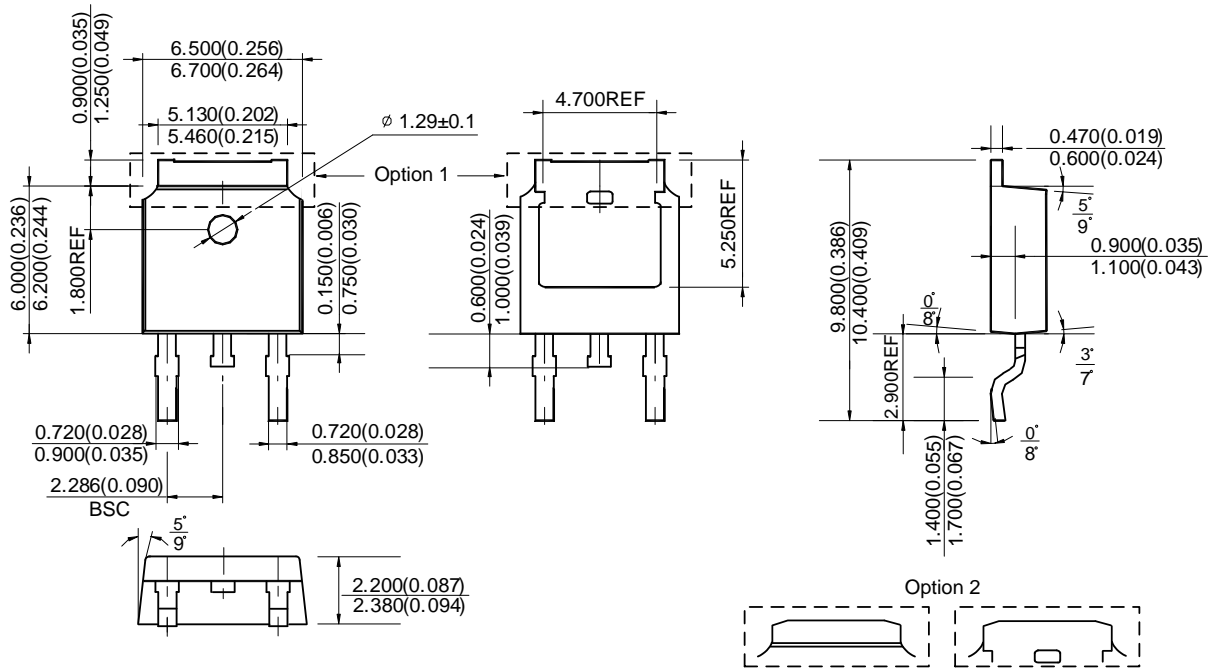

Package Outline Dimensions (Cont. All dimensions in mm(inch).)

(6) Package Type: TO-252-2 (4)

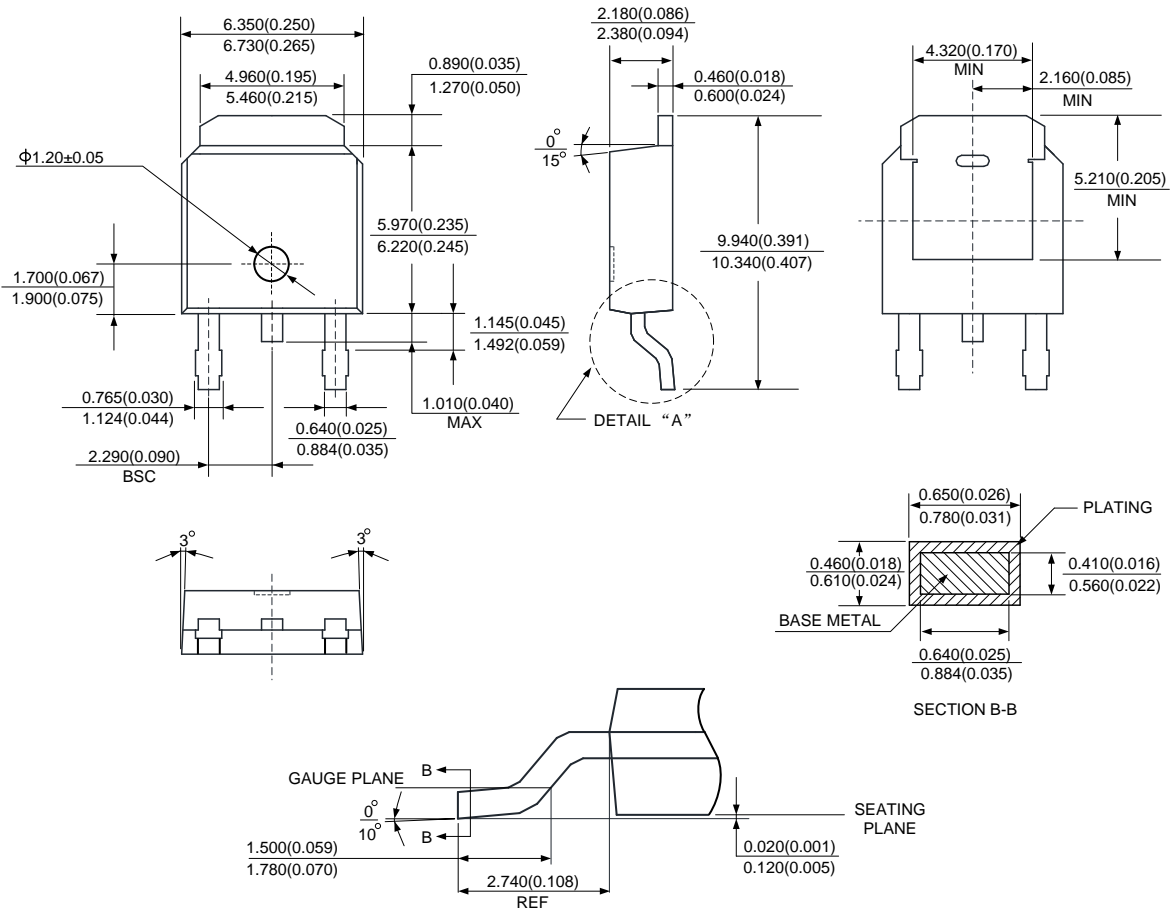

Package Outline Dimensions (Cont. All dimensions in mm(inch).)

(7) Package Type: TO-252-2 (5)

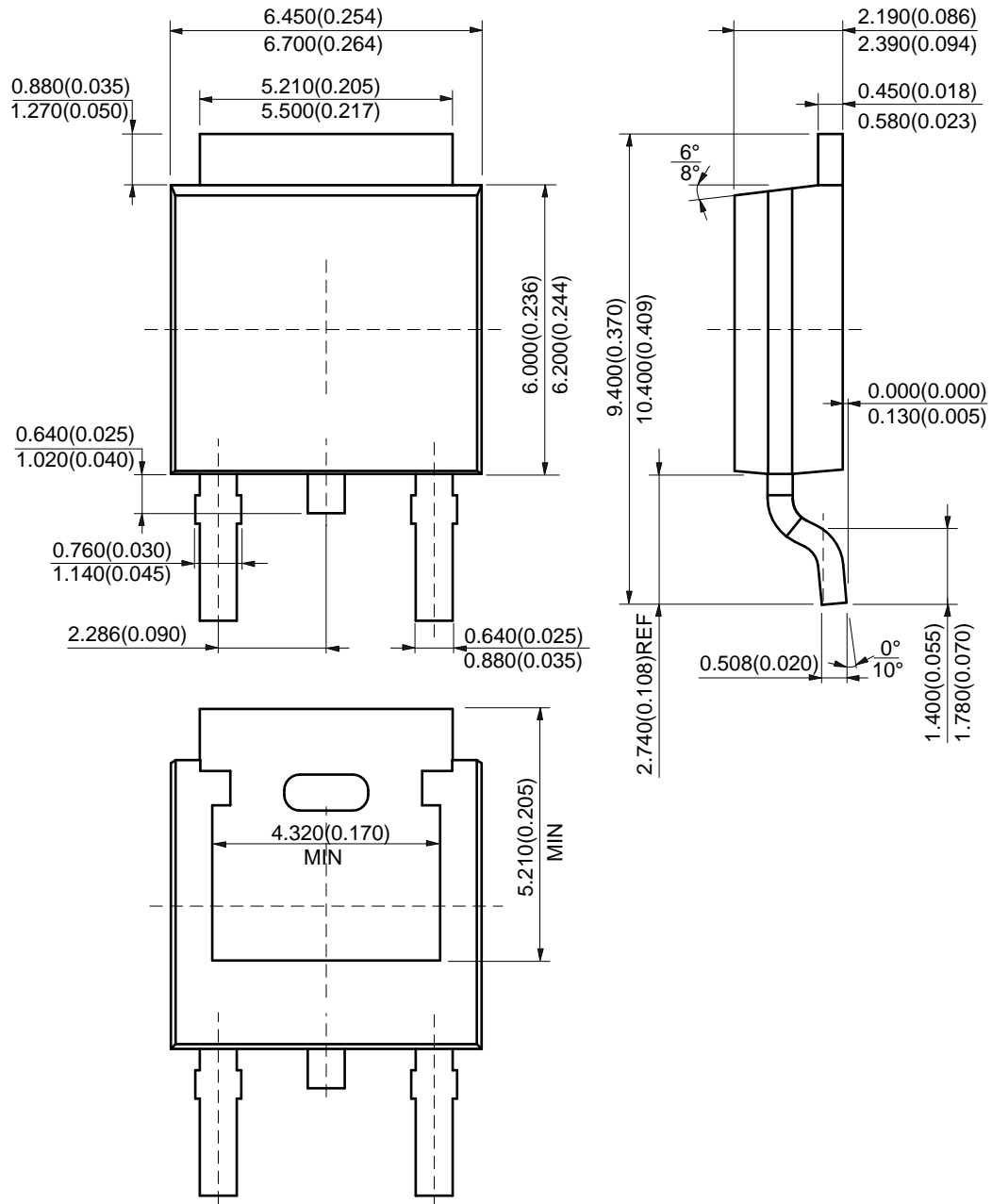

Suggested Pad Layout

(1) Package Type: TO-263-3

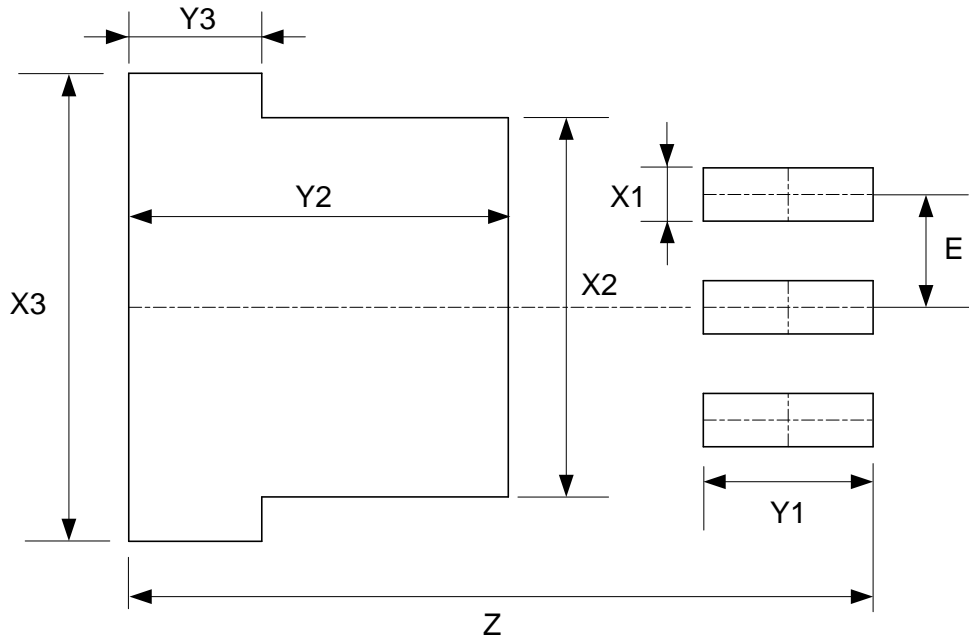

Dimensions	Z (mm)/(inch)	X1 (mm)/(inch)	X2 (mm)/(inch)	X3 (mm)/(inch)
Value	16.760/0.660	1.200/0.047	8.540/0.336	10.540/0.415
Dimensions	Y1 (mm)/(inch)	Y2 (mm)/(inch)	Y3 (mm)/(inch)	E (mm)/(inch)
Value	3.830/0.151	8.560/0.337	3.000/0.118	2.540/0.100

Suggested Pad Layout (Cont.)

(2) Package Type: SOT-223

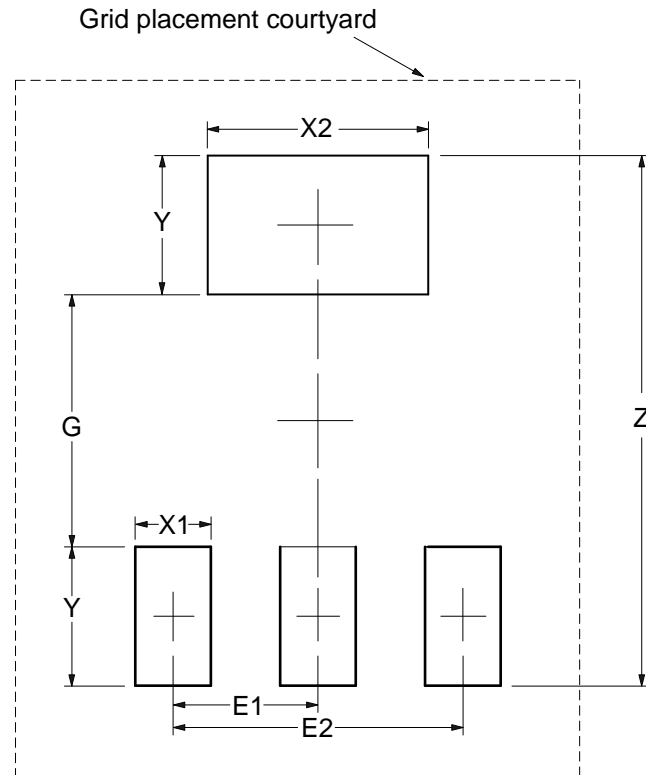

Dimensions	Z (mm)/(inch)	G (mm)/(inch)	X1 (mm)/(inch)	X2 (mm)/(inch)	Y (mm)/(inch)	E1 (mm)/(inch)	E2 (mm)/(inch)
Value	8.400/0.331	4.000/0.157	1.200/0.047	3.500/0.138	2.200/0.087	2.300/0.091	4.600/0.181

Suggested Pad Layout (Cont.)

(3) Package Type: TO-252-2 (3)

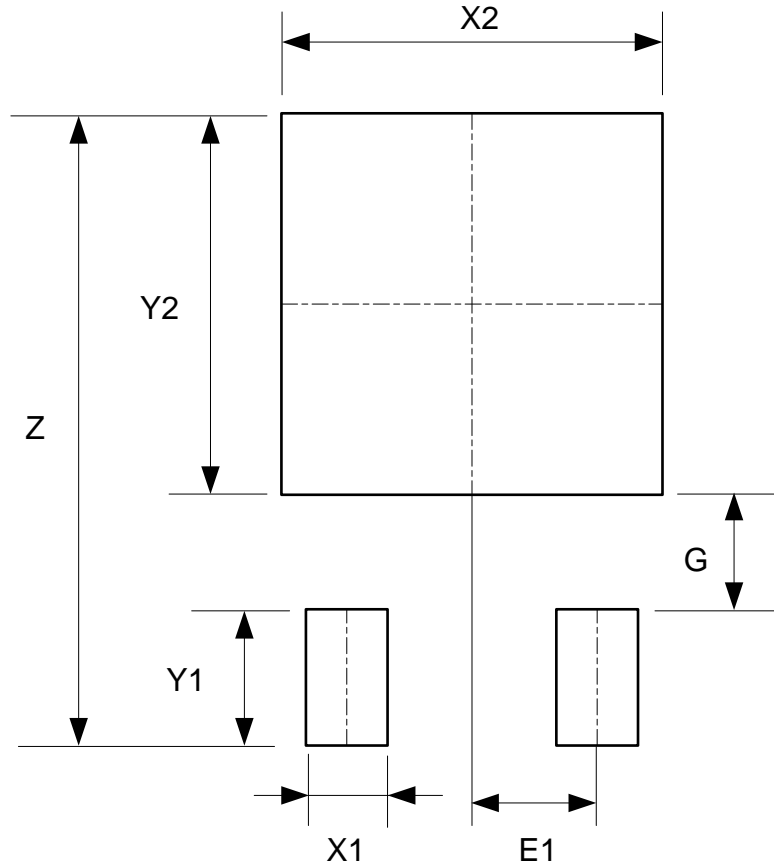

Dimensions	Z (mm)/(inch)	X1 (mm)/(inch)	X2=Y2 (mm)/(inch)	Y1 (mm)/(inch)	G (mm)/(inch)	E1 (mm)/(inch)
Value	11.600/0.457	1.500/0.059	7.000/0.276	2.500/0.098	2.100/0.083	2.300/0.091

Suggested Pad Layout (Cont.)

(4) Package Type: TO-252-2 (4)

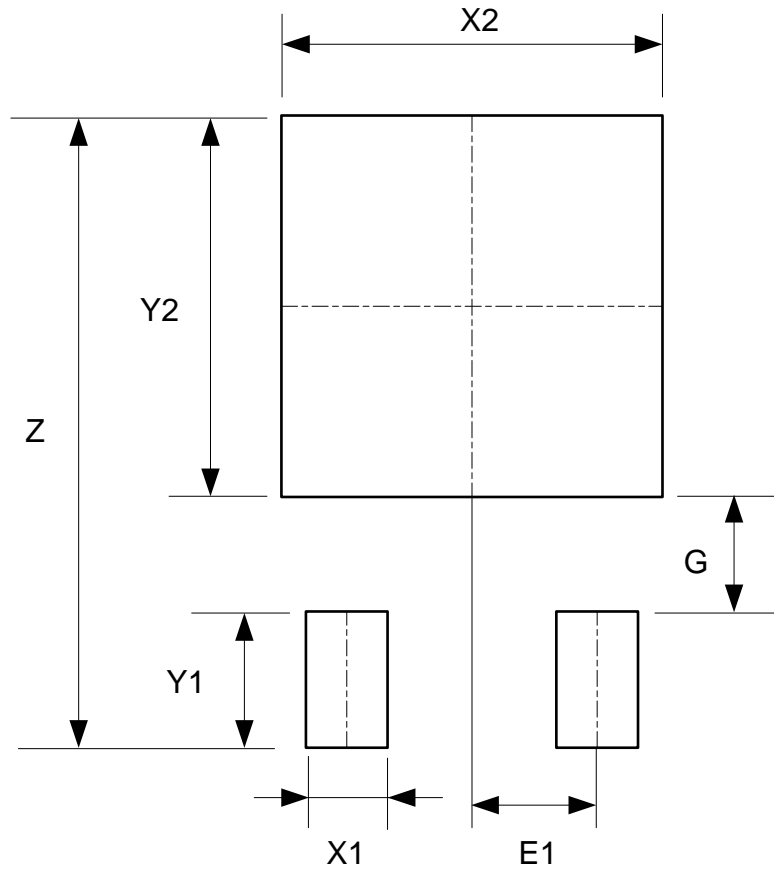

Dimensions	Z (mm)/(inch)	X1 (mm)/(inch)	X2=Y2 (mm)/(inch)	Y1 (mm)/(inch)	G (mm)/(inch)	E1 (mm)/(inch)
Value	11.600/0.457	1.500/0.059	7.000/0.276	2.500/0.098	2.100/0.083	2.300/0.091

Suggested Pad Layout (Cont.)

(5) Package Type: TO-252-2 (5)

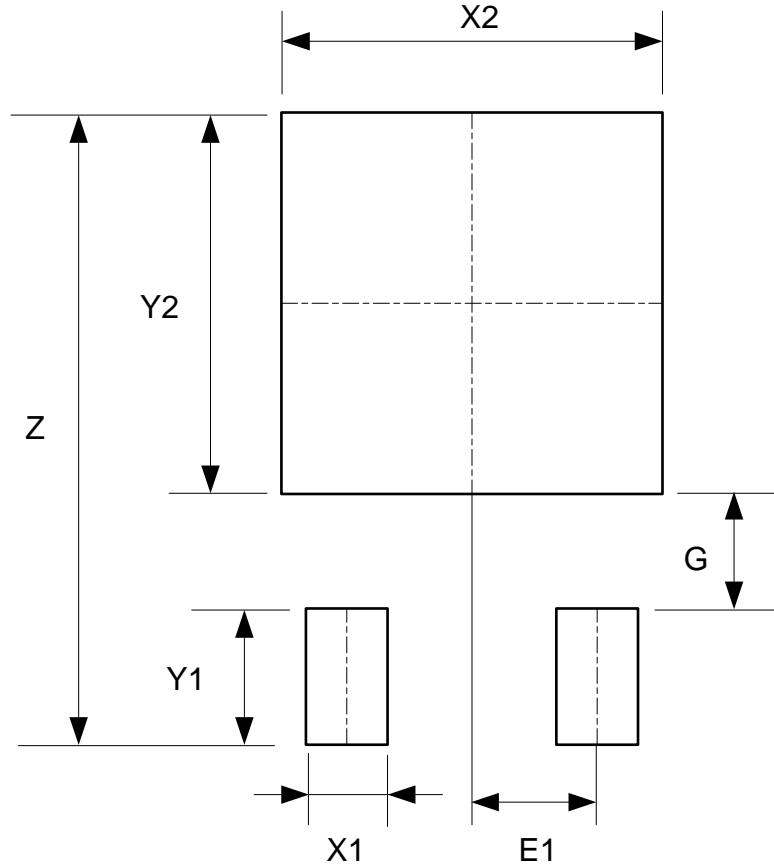

Dimensions	Z (mm)/(inch)	X1 (mm)/(inch)	X2=Y2 (mm)/(inch)	Y1 (mm)/(inch)	G (mm)/(inch)	E1 (mm)/(inch)
Value	11.600/0.457	1.500/0.059	7.000/0.276	2.500/0.098	2.100/0.083	2.300/0.091

IMPORTANT NOTICE

DIODES INCORPORATED MAKES NO WARRANTY OF ANY KIND, EXPRESS OR IMPLIED, WITH REGARDS TO THIS DOCUMENT, INCLUDING, BUT NOT LIMITED TO, THE IMPLIED WARRANTIES OF MERCHANTABILITY AND FITNESS FOR A PARTICULAR PURPOSE (AND THEIR EQUIVALENTS UNDER THE LAWS OF ANY JURISDICTION).

Diodes Incorporated and its subsidiaries reserve the right to make modifications, enhancements, improvements, corrections or other changes without further notice to this document and any product described herein. Diodes Incorporated does not assume any liability arising out of the application or use of this document or any product described herein; neither does Diodes Incorporated convey any license under its patent or trademark rights, nor the rights of others. Any Customer or user of this document or products described herein in such applications shall assume all risks of such use and will agree to hold Diodes Incorporated and all the companies whose products are represented on Diodes Incorporated website, harmless against all damages.

Diodes Incorporated does not warrant or accept any liability whatsoever in respect of any products purchased through unauthorized sales channel. Should Customers purchase or use Diodes Incorporated products for any unintended or unauthorized application, Customers shall indemnify and hold Diodes Incorporated and its representatives harmless against all claims, damages, expenses, and attorney fees arising out of, directly or indirectly, any claim of personal injury or death associated with such unintended or unauthorized application.

Products described herein may be covered by one or more United States, international or foreign patents pending. Product names and markings noted herein may also be covered by one or more United States, international or foreign trademarks.

This document is written in English but may be translated into multiple languages for reference. Only the English version of this document is the final and determinative format released by Diodes Incorporated.

LIFE SUPPORT

Diodes Incorporated products are specifically not authorized for use as critical components in life support devices or systems without the express written approval of the Chief Executive Officer of Diodes Incorporated. As used herein:

A. Life support devices or systems are devices or systems which:

1. are intended to implant into the body, or
2. support or sustain life and whose failure to perform when properly used in accordance with instructions for use provided in the labeling can be reasonably expected to result in significant injury to the user.

B. A critical component is any component in a life support device or system whose failure to perform can be reasonably expected to cause the failure of the life support device or to affect its safety or effectiveness.

Customers represent that they have all necessary expertise in the safety and regulatory ramifications of their life support devices or systems, and acknowledge and agree that they are solely responsible for all legal, regulatory and safety-related requirements concerning their products and any use of Diodes Incorporated products in such safety-critical, life support devices or systems, notwithstanding any devices- or systems-related information or support that may be provided by Diodes Incorporated. Further, Customers must fully indemnify Diodes Incorporated and its representatives against any damages arising out of the use of Diodes Incorporated products in such safety-critical, life support devices or systems.

Copyright © 2015, Diodes Incorporated

www.diodes.com

X-ON Electronics

Largest Supplier of Electrical and Electronic Components

Click to view similar products for [LDO Voltage Regulators](#) category:

Click to view products by [Diodes Incorporated](#) manufacturer:

Other Similar products are found below :

[AP7363-SP-13](#) [L79M05TL-E](#) [PT7M8202B12TA5EX](#) [TCR3DF185,LM\(CT](#) [MP2013GQ-33-Z](#) [059985X](#) [NCP4687DH15T1G](#) [701326R](#)
[TCR2EN28,LF\(S](#) [NCV8170AXV250T2G](#) [TCR2EN18,LF\(S](#) [AP7315-25W5-7](#) [IFX30081LDVGRNXUMA1](#) [NCV47411PAAJR2G](#)
[AP2113KTR-G1](#) [AP2111H-1.2TRG1](#) [ZLDO1117QK50TC](#) [AZ1117IH-1.8TRG1](#) [TCR3DG12,LF](#) [MIC5514-3.3YMT-T5](#) [MIC5512-1.2YMT-](#)
[T5](#) [MIC5317-2.8YM5-T5](#) [SCD7912BTG](#) [NCP154MX180270TAG](#) [SCD33269T-5.0G](#) [NCV8170BMX330TCG](#) [NCV8170AMX120TCG](#)
[NCP706ABMX300TAG](#) [NCP153MX330180TCG](#) [NCP114BMX075TCG](#) [MC33269T-3.5G](#) [CAT6243-ADJCMT5T](#) [TCR3DG33,LF](#)
[AP2127N-1.0TRG1](#) [TCR4DG35,LF](#) [LT1117CST-3.3](#) [LT1117CST-5](#) [TAR5S15U\(TE85L,F\)](#) [TAR5S18U\(TE85L,F\)](#) [TCR3UG19A,LF](#)
[TCR4DG105,LF](#) [NCV8170AMX360TCG](#) [MIC94310-NYMT-T5](#) [NCV8186BMN175TAG](#) [NCP715SQ15T2G](#) [MIC5317-3.0YD5-T5](#)
[NCV563SQ18T1G](#) [MIC5317-2.8YD5-T5](#) [NCP715MX30TBG](#) [MIC5317-2.5YD5-T5](#)