

Product Summary

- Continuous Drain Source Voltage: $V_{DS} = 60V$
- On-State Resistance: 550m Ω
- Nominal Load Current ($V_{IN} = 5V$) : 1.4A
- Clamping Energy: 550mJ

Description

The BSP75GQ is a Self-protected low-side MOSFET. It features monolithic over temperature, over current, over voltage (active clamp) and ESD protected logic level functionality. It is intended as a general purpose switch.

Applications

- Especially Suited for Loads with a High In-Rush Current such as Lamps and Motors
- All Types of Resistive, Inductive and Capacitive Loads in Switching Applications
- μC Compatible Power Switch for 12V and 24V DC Applications
- Automotive Rated
- Replaces Electromechanical Relays and Discrete Circuits
- Linear Mode Capability - the current-limiting protection circuitry is designed to de-activate at low V_{DS} in order not to compromise the load current during normal operation. The maximum DC operating current is therefore determined by the thermal capability of the package/board combination, rather than by the protection circuitry.

SOT223 (Type DN)

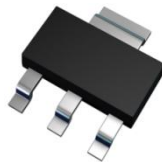

Top View

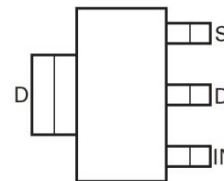

Top View
Pin Out

Note: The tab is connected to the drain pin, and must be electrically isolated from the source pin. Connection of significant copper to the tab is recommended for best thermal performance.

Ordering Information (Note 5)

Product	Marking	Reel Size (inches)	Tape Width (mm)	Quantity per Reel
BSP75GQTA	BSP75G	7	12	1,000 Units
BSP75GQTC	BSP75G	13	12	4,000 Units

- Notes:
1. EU Directive 2002/95/EC (RoHS), 2011/65/EU (RoHS 2) & 2015/863/EU (RoHS 3) compliant. All applicable RoHS exemptions applied.
 2. See http://www.diodes.com/quality/lead_free/ for more information about Diodes Incorporated's definitions of Halogen- and Antimony-free, "Green" and Lead-free.
 3. Halogen- and Antimony-free "Green" products are defined as those which contain <900ppm bromine, <900ppm chlorine (<1500ppm total Br + Cl) and <1000ppm antimony compounds.
 4. Automotive products are AEC-Q101 qualified and are PPAP capable. Refer to <https://www.diodes.com/quality/>.
 5. For packaging details, go to our website at <https://www.diodes.com/design/support/packaging/diodes-packaging/>.

IntelliFET is a trademark of Diodes Incorporated.

BSP75GQ

Document number: DS37144 Rev. 5 - 2

Marking Information

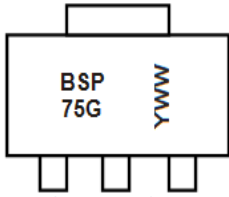

BSP75G = Product Type Marking Code
 YWW = Date Code Marking
 Y or \bar{Y} = Last Digit of Year (ex: 8 = 2018)
 WW or $\bar{W}W$ = Week Code (01 to 53)

Functional Block Diagram

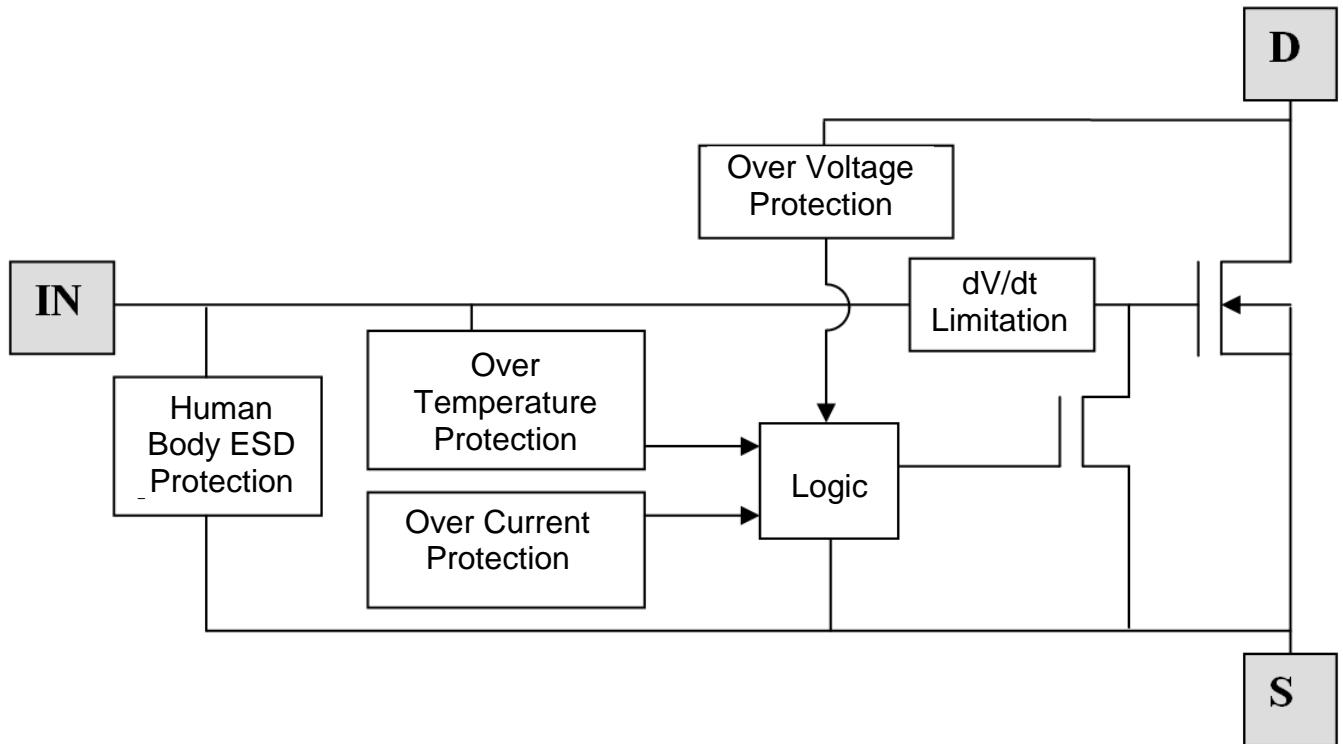

Absolute Maximum Ratings (@T_A = +25°C, unless otherwise stated.)

Parameter	Symbol	Limit	Unit
Continuous Drain-Source Voltage	V _{DS}	60	V
Drain-Source Voltage for Short Circuit Protection V _{IN} = 5V	V _{DS(SC)}	36	V
Continuous Input Voltage	V _{IN}	-0.2 to +10	V
Peak Input Voltage	V _{IN}	-0.2 to +20	V
Operating Temperature Range	T _J	-40 to +150	°C
Storage Temperature Range	T _{STG}	-55 to +150	°C
Power Dissipation at T _A = +25°C (Note 6)	P _D	2.5	W
Continuous Drain Current @ V _{IN} = 10V; T _A = +25°C (Note 6)	I _D	1.6	A
Continuous Drain Current @ V _{IN} = 5V; T _A = +25°C (Note 6)	I _D	1.4	A
Pulsed Drain Current @ V _{IN} = 10V	I _{DM}	5	A
Continuous Source Current (Body Diode) (Note 6)	I _S	3	A
Pulsed Source Current (Body Diode)	I _S	5	A
Unclamped Single Pulse Inductive Energy	E _{AS}	550	mJ
Load Dump Protection	V _{LOAD_DUMP}	80	V
Electrostatic Discharge (Human Body Model)	V _{ESD}	4000	V
DIN Humidity Category, DIN 40 040	—	E	—
IEC Climatic Category, DIN IEC 68-1	—	40/150/56	—

Thermal Resistance

Characteristic	Symbol	Limit	Unit
Junction to Ambient (Note 6)	R _{θJA}	50	°C/W
Junction to Ambient (Note 7)	R _{θJA}	24	°C/W
Junction to Ambient (Note 8)	R _{θJA}	208	°C/W

- Notes:
6. For a device surface mounted on 37mm x 37mm x 1.6mm FR-4 board with a high coverage of single sided 2oz weight copper.
 7. For a device surface mounted on FR-4 board and measured at t<=10s.
 8. For a device mounted on FR-4 board with the minimum copper required for electrical connections.

Typical Characteristics

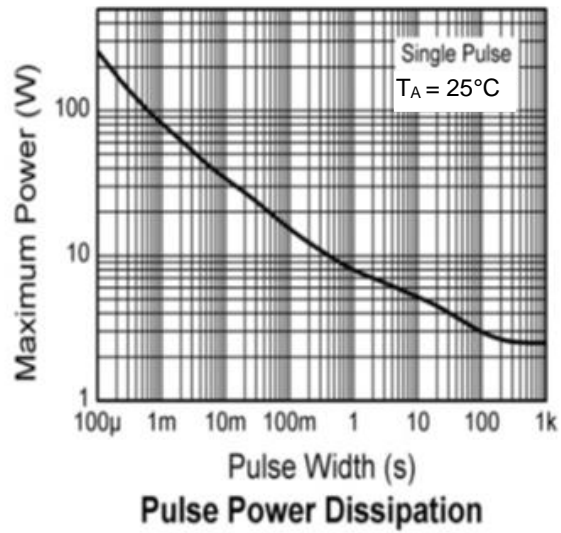
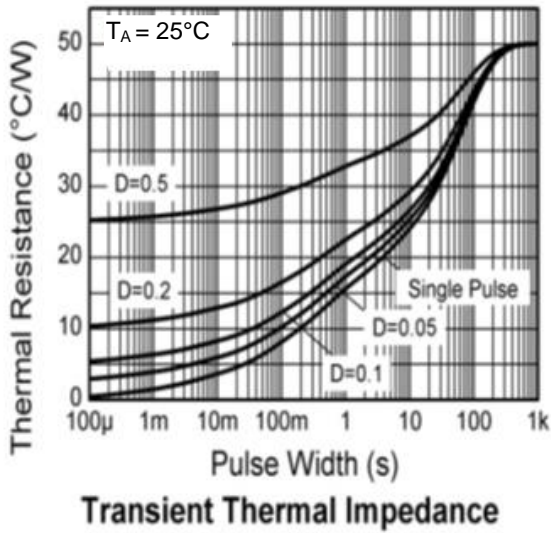
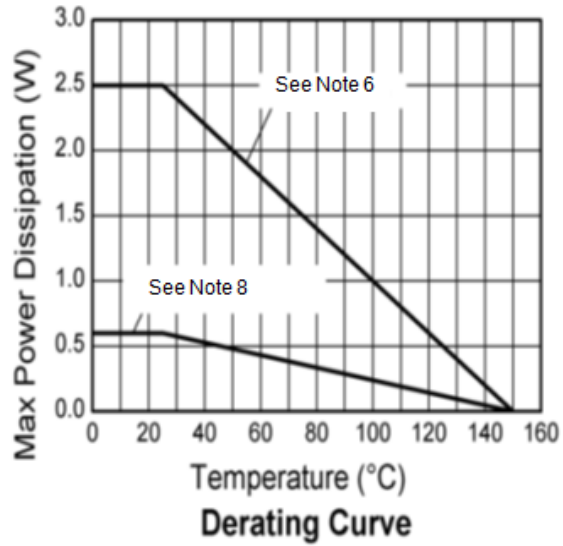
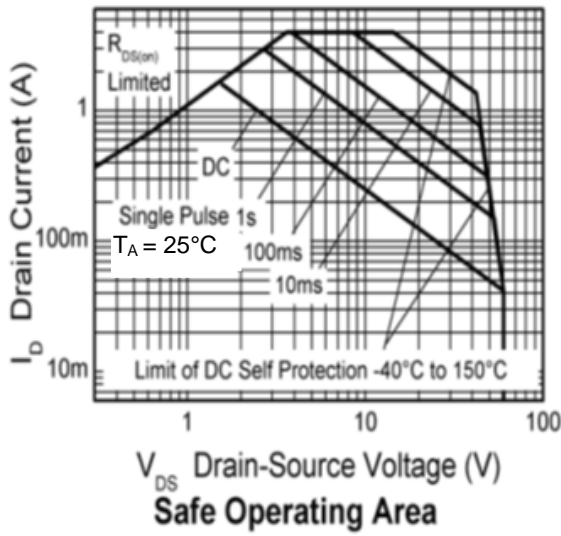

Electrical Characteristics (@ $T_A = +25^\circ\text{C}$, unless otherwise stated.)

Parameter	Symbol	Min.	Typ.	Max.	Unit	Conditions
Static Characteristics						
Drain-Source Clamp Voltage	$V_{DS(AZ)}$	60	70	75	V	$I_D=10\text{mA}$
Off state Drain Current	I_{DSS}	—	0.1	3	μA	$V_{DS}=12\text{V}, V_{IN}=0\text{V}$
Off state Drain Current	I_{DSS}	—	3	15	μA	$V_{DS}=32\text{V}, V_{IN}=0\text{V}$
Input Threshold Voltage (Note 9)	$V_{IN(TH)}$	1	2.1	—	V	$V_{DS}=V_{GS}, I_D=1\text{mA}$
Input Current	I_{IN}	—	0.7	1.2	mA	$V_{IN}=5\text{V}$
Input Current	I_{IN}	—	1.5	2.7	mA	$V_{IN}=7\text{V}$
Input Current	I_{IN}	—	4	7	mA	$V_{IN}=10\text{V}$
Static Drain-Source On-State Resistance	$R_{DS(ON)}$	—	520	675	$\text{m}\Omega$	$V_{IN}=5\text{V}, I_D=0.7\text{A}$
Static Drain-Source On-State Resistance	$R_{DS(ON)}$	—	385	550	$\text{m}\Omega$	$V_{IN}=10\text{V}, I_D=0.7\text{A}$
Current Limit (Note 10)	$I_{D(LIM)}$	0.7	1.1	1.75	A	$V_{IN}=5\text{V}, V_{DS}>5\text{V}$
Current Limit (Note 10)	$I_{D(LIM)}$	2	3	4	A	$V_{IN}=10\text{V}, V_{DS}>5\text{V}$
Dynamic Characteristics						
Turn-On Time (V_{IN} to 90% I_D)	t_{ON}	—	2.2	—	μs	$R_L=22\Omega, V_{IN}=0$ to $10\text{V}, V_{DD}=12\text{V}$
Turn-Off Time (V_{IN} to 90% I_D)	t_{OFF}	—	13	—	μs	$R_L=22\Omega, V_{IN}=10\text{V}$ to $0\text{V}, V_{DD}=12\text{V}$
Slew Rate On (70 to 50% V_{DD})	$-dV_{DS}/dt_{ON}$	—	10	—	$\text{V}/\mu\text{s}$	$R_L=22\Omega, V_{IN}=0$ to $10\text{V}, V_{DD}=12\text{V}$
Slew Rate Off (50 to 70% V_{DD})	dV_{DS}/dt_{ON}	—	3.2	—	$\text{V}/\mu\text{s}$	$R_L=22\Omega, V_{IN}=10\text{V}$ to $0\text{V}, V_{DD}=12\text{V}$
Protection Functions (Note 11)						
Minimum Input Voltage for Over Temperature Protection	V_{PROT}	4.5	—	—	V	—
Thermal Overload Trip Temperature	T_{JT}	+150	+175	—	$^\circ\text{C}$	—
Thermal Hysteresis	—	—	+10	—	$^\circ\text{C}$	—
Unclamped Single Pulse Inductive Energy $T_J = +25^\circ\text{C}$	E_{AS}	550	—	—	mJ	$I_{D(ISO)}=0.7\text{A}, V_{DD}=32\text{V}$
Unclamped Single Pulse Inductive Energy $T_J = +150^\circ\text{C}$	E_{AS}	200	—	—	mJ	$I_{D(ISO)}=0.7\text{A}, V_{DD}=32\text{V}$
Inverse Diode						
Source Drain Voltage	V_{SD}	—	—	1	V	$V_{IN}=0\text{V}, -I_D=1.4\text{A}$

Notes: 9. Protection features may operate outside spec for $V_{IN} < 4.5\text{V}$.

10. The drain current is limited to a reduced value when V_{DS} exceeds a safe level.

11. Integrated protection functions are designed to prevent IC destruction under fault conditions described in the datasheet. Fault conditions are considered as "outside" normal operating range. Protection functions are not designed for continuous, repetitive operation.

Typical Characteristics

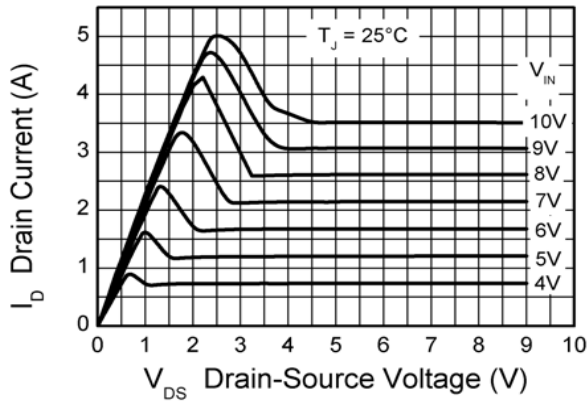

Typical Output Characteristic

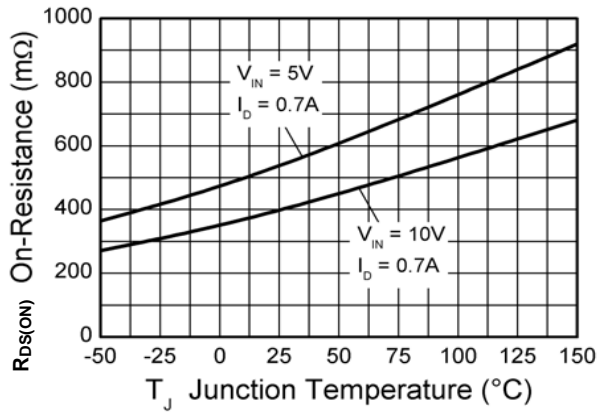

On-state Resistance vs Temperature

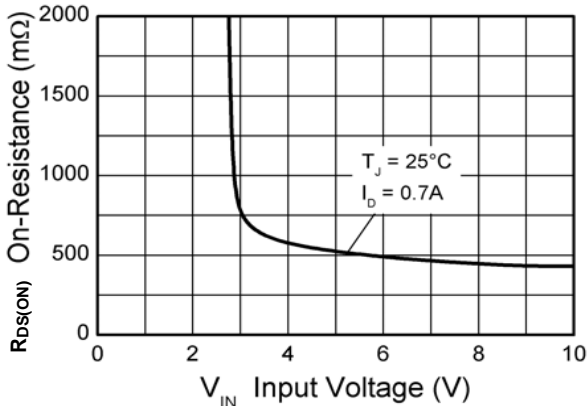

On-Resistance vs Input Voltage

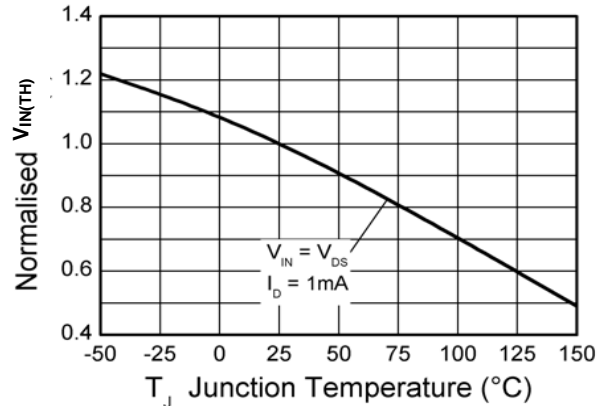

Threshold Voltage vs Temperature

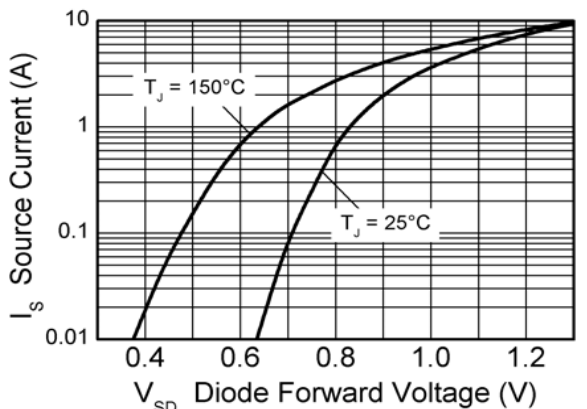

Source-Drain Diode Forward Voltage

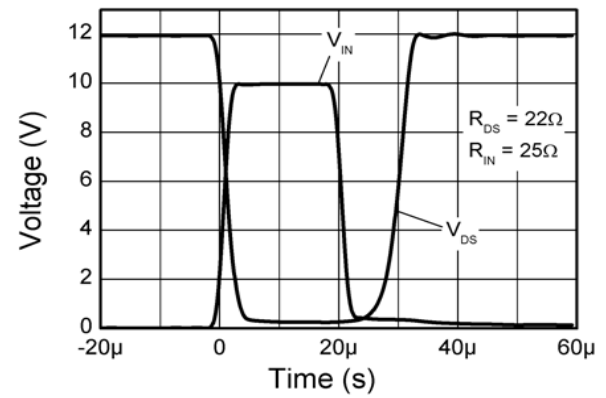

Switching Speed

Package Outline Dimensions

Please see <http://www.diodes.com/package-outlines.html> for the latest version.

SOT223 (Type DN)

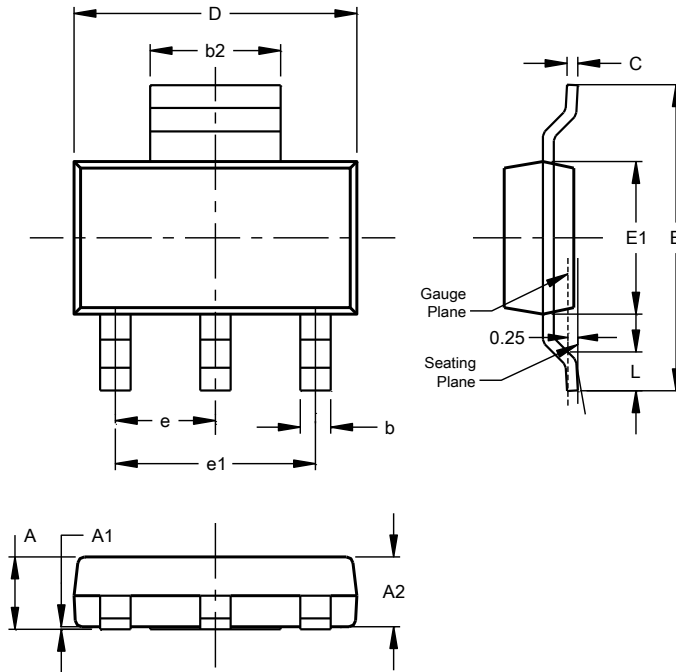

SOT223 (Type DN)			
Dim	Min	Max	Typ
A	--	1.70	--
A1	0.01	0.15	--
A2	1.50	1.68	1.60
b	0.60	0.80	0.70
b2	2.90	3.10	--
c	0.20	0.32	--
D	6.30	6.70	--
E	6.70	7.30	--
E1	3.30	3.70	--
e	--	--	2.30
e1	--	--	4.60
L	0.85	--	--
All Dimensions in mm			

Suggested Pad Layout

Please see <http://www.diodes.com/package-outlines.html> for the latest version.

SOT223 (Type DN)

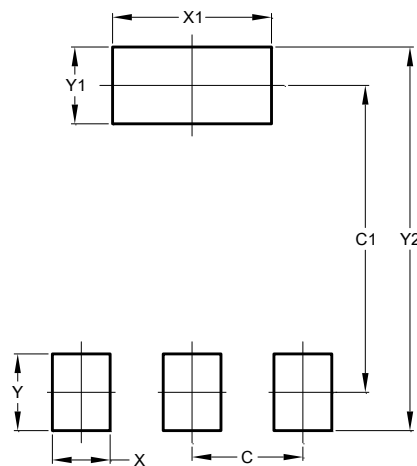

Dimensions	Value (in mm)
C	2.30
C1	6.40
X	1.20
X1	3.30
Y	1.60
Y1	1.60
Y2	8.00

IMPORTANT NOTICE

DIODES INCORPORATED MAKES NO WARRANTY OF ANY KIND, EXPRESS OR IMPLIED, WITH REGARDS TO THIS DOCUMENT, INCLUDING, BUT NOT LIMITED TO, THE IMPLIED WARRANTIES OF MERCHANTABILITY AND FITNESS FOR A PARTICULAR PURPOSE (AND THEIR EQUIVALENTS UNDER THE LAWS OF ANY JURISDICTION).

Diodes Incorporated and its subsidiaries reserve the right to make modifications, enhancements, improvements, corrections or other changes without further notice to this document and any product described herein. Diodes Incorporated does not assume any liability arising out of the application or use of this document or any product described herein; neither does Diodes Incorporated convey any license under its patent or trademark rights, nor the rights of others. Any Customer or user of this document or products described herein in such applications shall assume all risks of such use and will agree to hold Diodes Incorporated and all the companies whose products are represented on Diodes Incorporated website, harmless against all damages.

Diodes Incorporated does not warrant or accept any liability whatsoever in respect of any products purchased through unauthorized sales channel. Should Customers purchase or use Diodes Incorporated products for any unintended or unauthorized application, Customers shall indemnify and hold Diodes Incorporated and its representatives harmless against all claims, damages, expenses, and attorney fees arising out of, directly or indirectly, any claim of personal injury or death associated with such unintended or unauthorized application.

Products described herein may be covered by one or more United States, international or foreign patents pending. Product names and markings noted herein may also be covered by one or more United States, international or foreign trademarks.

This document is written in English but may be translated into multiple languages for reference. Only the English version of this document is the final and determinative format released by Diodes Incorporated.

LIFE SUPPORT

Diodes Incorporated products are specifically not authorized for use as critical components in life support devices or systems without the express written approval of the Chief Executive Officer of Diodes Incorporated. As used herein:

A. Life support devices or systems are devices or systems which:

1. are intended to implant into the body, or
2. support or sustain life and whose failure to perform when properly used in accordance with instructions for use provided in the labeling can be reasonably expected to result in significant injury to the user.

B. A critical component is any component in a life support device or system whose failure to perform can be reasonably expected to cause the failure of the life support device or to affect its safety or effectiveness.

Customers represent that they have all necessary expertise in the safety and regulatory ramifications of their life support devices or systems, and acknowledge and agree that they are solely responsible for all legal, regulatory and safety-related requirements concerning their products and any use of Diodes Incorporated products in such safety-critical, life support devices or systems, notwithstanding any devices- or systems-related information or support that may be provided by Diodes Incorporated. Further, Customers must fully indemnify Diodes Incorporated and its representatives against any damages arising out of the use of Diodes Incorporated products in such safety-critical, life support devices or systems.

Copyright © 2018, Diodes Incorporated

www.diodes.com

X-ON Electronics

Largest Supplier of Electrical and Electronic Components

Click to view similar products for [Power Switch ICs - Power Distribution](#) *category:*

Click to view products by [Diodes Incorporated](#) *manufacturer:*

Other Similar products are found below :

[TCK111G,LF\(S\)](#) [FPF1018](#) [DS1222](#) [TCK2065G,LF](#) [SZNCP3712ASNT3G](#) [MIC2033-05BYMT-T5](#) [MIC2033-12AYMT-T5](#) [MIC2033-05BYM6-T5](#) [SLG5NT1437VTR](#) [SZNCP3712ASNT1G](#) [DML1008LDS-7](#) [KTS1670EDA-TR](#) [KTS1640QGDV-TR](#) [KTS1641QGDV-TR](#) [U6513A](#) [MIC2012YM-TR](#) [MP5095GJ-P](#) [TPS2021IDRQ1](#) [TPS2104DBVR](#) [MIC2098-1YMT-TR](#) [MIC94062YMT TR](#) [MIC2015-1.2YM6 TR](#) [MIC2075-2YM](#) [MIC94068YML-TR](#) [SIP32461DB-T2-GE1](#) [NCP335FCT2G](#) [FPF1504UCX](#) [TCK105G,LF\(S\)](#) [AP2411S-13](#) [AP2151DSG-13](#) [AP2172MPG-13](#) [MIC94094YC6-TR](#) [MIC94093YC6-TR](#) [MIC94064YC6-TR](#) [MIC94061YMT-TR](#) [MIC2505-1YM](#) [MIC94085YFT-TR](#) [MIC94042YFL-TR](#) [MIC2005-1.2YM6-TR](#) [SIP32510DT-T1-GE3](#) [NCP333FCT2G](#) [NCP331SNT1G](#) [TPS2092DR](#) [TPS2063DR](#) [MIC2008YML-TR](#) [MIC94084YFT-TR](#) [DIO1280WL12](#) [BTS70202EPAXUMA1](#) [AP22814ASN-7](#) [MIC2043-2YTS](#)