

## Product Summary

<b>V<sub>BR</sub> (Min)</b>	<b>I<sub>PP</sub> (Max)</b>	<b>C<sub>T</sub> (Typ)</b>
5.8V	60A	260pF

## Description

This new generation TVS is designed to protect sensitive electronics from the damage due to ESD and Surge. The combination of small size and high ESD surge capability makes it ideal for use in portable applications such as cellular phones, digital cameras, and MP3 players.

## Applications

- Cellular Handsets
- Portable Electronics
- Computers and Peripheral

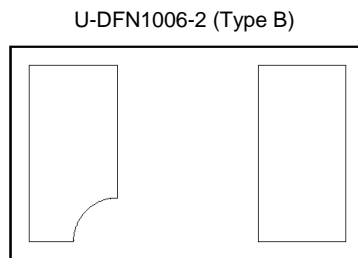

Bottom View

## Features

- Low Profile Package (0.50mm Typical) and Ultra-Small PCB Footprint Area (1.3mm × 0.55mm Max) Suitable for Compact Portable Electronics
- Provides ESD Protection per IEC 61000-4-2 Standard: Air ±30kV, Contact ±30kV
- Provides Surge and Lightning Protection per IEC 61000-4-5 Standard: I<sub>PP</sub> Max 60A
- One Channel of ESD and Surge Protection
- **Totally Lead-Free & Fully RoHS Compliant (Notes 1 & 2)**
- **Halogen and Antimony Free. "Green" Device (Note 3)**
- **For automotive applications requiring specific change control (i.e. parts qualified to AEC-Q100/101/200, PPAP capable, and manufactured in IATF 16949 certified facilities), please [contact us](https://www.diodes.com/quality/product-definitions/) or your local Diodes representative.**

## Mechanical Data

- Case: U-DFN1006-2
- Case Material: Molded Plastic, "Green" Molding Compound. UL Flammability Classification Rating 94V-0
- Moisture Sensitivity: Level 1 per J-STD-020
- Terminals: NiPdAu over Copper Leadframe. Solderable per MIL-STD-202, Method 208 (64)
- Weight: 0.001 grams (Approximate)



Device Schematic

## Ordering Information (Note 4)

Part Number	Compliance	Marking	Reel Size (inches)	Tape Width (mm)	Quantity
D5V0S1US2LP-7B	Standard	1N	7	8	10,000/Tape & Reel

- Notes:
1. No purposely added lead. Fully EU Directive 2002/95/EC (RoHS), 2011/65/EU (RoHS 2) & 2015/863/EU (RoHS 3) compliant.
  2. See <https://www.diodes.com/quality/lead-free/> for more information about Diodes Incorporated's definitions of Halogen- and Antimony-free, "Green" and Lead-free.
  3. Halogen- and Antimony-free "Green" products are defined as those which contain <900ppm bromine, <900ppm chlorine (<1500ppm total Br + Cl) and <1000ppm antimony compounds.
  4. For packaging details, go to our website at <https://www.diodes.com/design/support/packaging/diodes-packaging/>.

## Marking Information

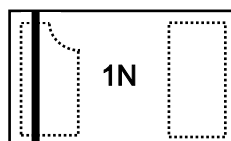

1N = Product Type Marking Code  
Bar Denotes Pin 1 or Cathode Side

**Maximum Ratings** (@T<sub>A</sub> = +25°C, unless otherwise specified.)

Characteristic	Symbol	Value	Unit	Conditions
Peak Pulse Power Dissipation (Pin1 to Pin2)	PPP	660	W	8/20μs, per Figure 3
Peak Pulse Current (Pin1 to Pin2)	I <sub>PP</sub>	60	A	8/20μs, per Figure 3
ESD Protection—Contact Discharge	V <sub>ESD_CONTACT</sub>	±30	kV	IEC 61000-4-2 Standard
ESD Protection—Air Discharge	V <sub>ESD_AIR</sub>	±30	kV	IEC 61000-4-2 Standard

**Thermal Characteristics**

Characteristic	Symbol	Value	Unit
Package Power Dissipation (Note 5)	P <sub>D</sub>	250	mW
Thermal Resistance, Junction to Ambient (Note 5)	R <sub>θJA</sub>	500	°C/W
Operating and Storage Temperature Range	T <sub>J</sub> , T <sub>STG</sub>	-55 to +150	°C

**Electrical Characteristics** (@T<sub>A</sub> = +25°C, unless otherwise specified.)

Characteristic	Symbol	Min	Typ	Max	Unit	Test Conditions
Reverse Working Voltage	V <sub>RWM</sub>	—	—	5.0	V	—
Reverse Current (Note 6)	I <sub>R</sub>	—	0.01	1.0	μA	V <sub>R</sub> = V <sub>RWM</sub>
Reverse Breakdown Voltage	V <sub>BR</sub>	5.8	—	8.0	V	I <sub>R</sub> = 1mA
Reverse Clamping Voltage	V <sub>CL</sub>	—	7.6	9.6	V	I <sub>PP</sub> = 30A, t <sub>P</sub> = 8/20μs
		—	9.0	11.0		I <sub>PP</sub> = 60A, t <sub>P</sub> = 8/20μs
Capacitance	C <sub>T</sub>	—	260	500	pF	V <sub>R</sub> = 0V, f = 1MHz

- Notes:
- Device mounted on FR-4 PCB pad layout (2oz copper) as shown on Diodes Incorporated's suggested pad layout, which can be found on our website at <http://www.diodes.com/package-outlines.html>.
  - Short duration pulse test used to minimize self-heating effect.

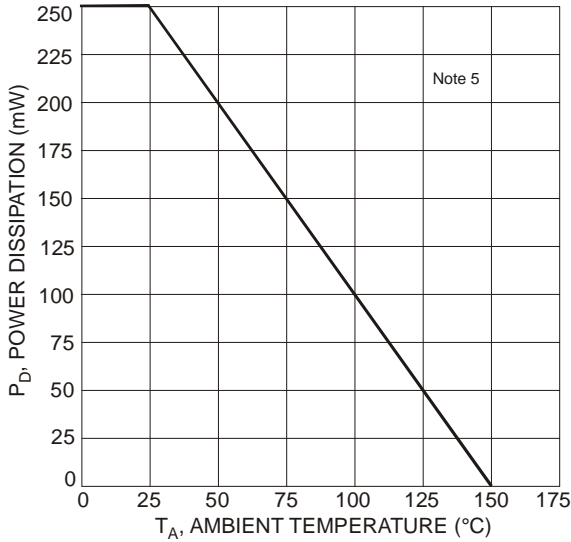

Figure 1 Power Derating Curve

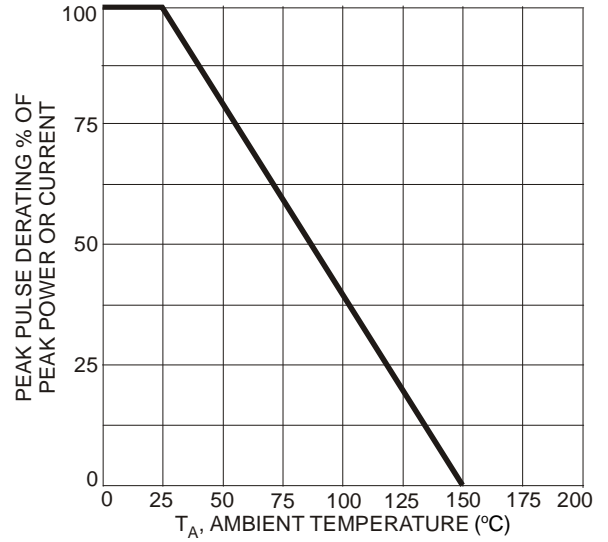

Figure 2 Pulse Derating Curve

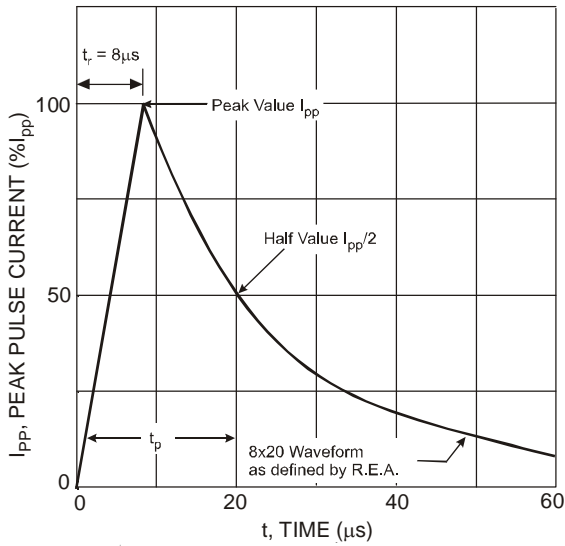

Figure 3 Typical 8 x 20µs Pulse Waveform

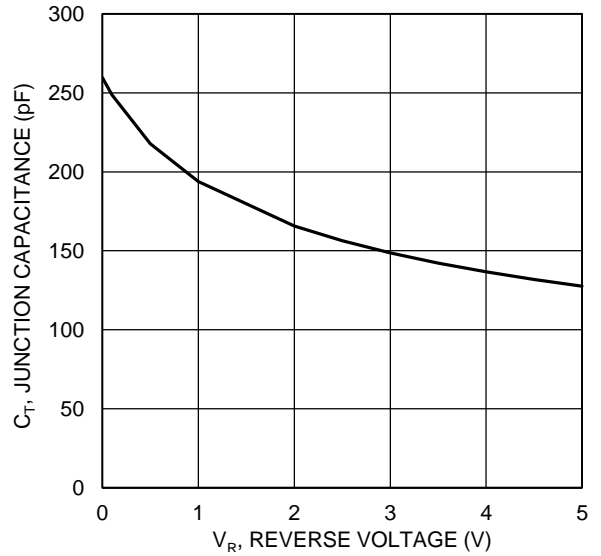

Figure 4 Typical Total Capacitance

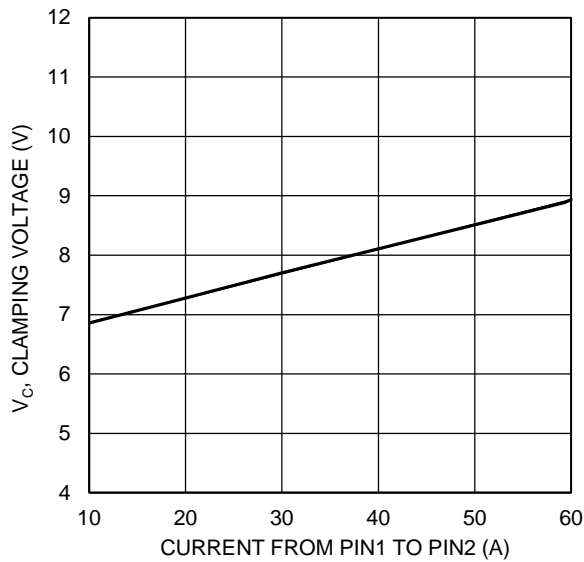

Figure 5 Clamping Voltage Characteristic ( $t_p=8/20\mu s$ )

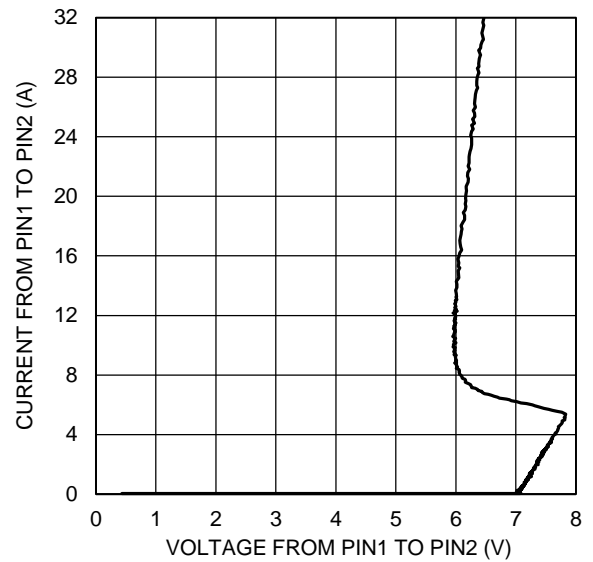
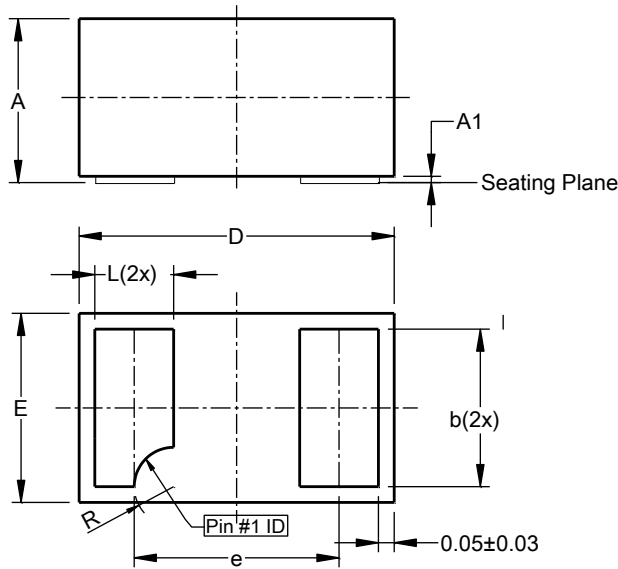

Figure 6 Positive TLP Curve ( $t_p=100ns$ )

**Package Outline Dimensions**

Please see <http://www.diodes.com/package-outlines.html> for the latest version.

**U-DFN1006-2 (Type B)**



U-DFN1006-2 (Type B)			
Dim	Min	Max	Typ
A	0.45	0.55	0.50
A1	0.00	0.05	0.03
b	0.45	0.55	0.50
D	0.95	1.05	1.00
E	0.55	0.65	0.60
e	0.65BSC		
L	0.20	0.30	0.25
R	0.075	0.175	0.125
All Dimensions in mm			

**Suggested Pad Layout**

Please see <http://www.diodes.com/package-outlines.html> for the latest version.

**U-DFN1006-2 (Type B)**

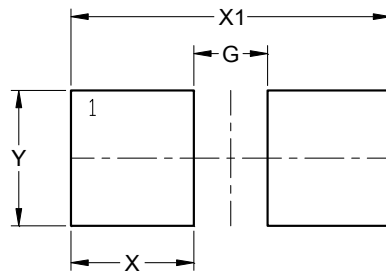

Dimensions	Value (in mm)
G	0.300
X	0.500
X1	1.300
Y1	0.550

**IMPORTANT NOTICE**

DIODES INCORPORATED MAKES NO WARRANTY OF ANY KIND, EXPRESS OR IMPLIED, WITH REGARDS TO THIS DOCUMENT, INCLUDING, BUT NOT LIMITED TO, THE IMPLIED WARRANTIES OF MERCHANTABILITY AND FITNESS FOR A PARTICULAR PURPOSE (AND THEIR EQUIVALENTS UNDER THE LAWS OF ANY JURISDICTION).

Diodes Incorporated and its subsidiaries reserve the right to make modifications, enhancements, improvements, corrections or other changes without further notice to this document and any product described herein. Diodes Incorporated does not assume any liability arising out of the application or use of this document or any product described herein; neither does Diodes Incorporated convey any license under its patent or trademark rights, nor the rights of others. Any Customer or user of this document or products described herein in such applications shall assume all risks of such use and will agree to hold Diodes Incorporated and all the companies whose products are represented on Diodes Incorporated website, harmless against all damages.

Diodes Incorporated does not warrant or accept any liability whatsoever in respect of any products purchased through unauthorized sales channel. Should Customers purchase or use Diodes Incorporated products for any unintended or unauthorized application, Customers shall indemnify and hold Diodes Incorporated and its representatives harmless against all claims, damages, expenses, and attorney fees arising out of, directly or indirectly, any claim of personal injury or death associated with such unintended or unauthorized application.

Products described herein may be covered by one or more United States, international or foreign patents pending. Product names and markings noted herein may also be covered by one or more United States, international or foreign trademarks.

This document is written in English but may be translated into multiple languages for reference. Only the English version of this document is the final and determinative format released by Diodes Incorporated.

**LIFE SUPPORT**

Diodes Incorporated products are specifically not authorized for use as critical components in life support devices or systems without the express written approval of the Chief Executive Officer of Diodes Incorporated. As used herein:

A. Life support devices or systems are devices or systems which:

1. are intended to implant into the body, or
2. support or sustain life and whose failure to perform when properly used in accordance with instructions for use provided in the labeling can be reasonably expected to result in significant injury to the user.

B. A critical component is any component in a life support device or system whose failure to perform can be reasonably expected to cause the failure of the life support device or to affect its safety or effectiveness.

Customers represent that they have all necessary expertise in the safety and regulatory ramifications of their life support devices or systems, and acknowledge and agree that they are solely responsible for all legal, regulatory and safety-related requirements concerning their products and any use of Diodes Incorporated products in such safety-critical, life support devices or systems, notwithstanding any devices- or systems-related information or support that may be provided by Diodes Incorporated. Further, Customers must fully indemnify Diodes Incorporated and its representatives against any damages arising out of the use of Diodes Incorporated products in such safety-critical, life support devices or systems.

Copyright © 2020, Diodes Incorporated

**www.diodes.com**

## X-ON Electronics

Largest Supplier of Electrical and Electronic Components

*Click to view similar products for [ESD Suppressors / TVS Diodes](#) category:*

*Click to view products by [Diodes Incorporated](#) manufacturer:*

Other Similar products are found below :

[60KS200C](#) [D12V0H1U2WS-7](#) [D18V0L1B2LP-7B](#) [82356050220](#) [D5V0F4U5P5-7](#) [D5V0M5U6V-7](#) [NTE4902](#) [P4KE27CA](#) [P6KE11CA](#)  
[P6KE39CA-TP](#) [P6KE8.2A](#) [SA110CA](#) [SA60CA](#) [SA64CA](#) [SMBJ12CATR](#) [SMBJ33CATR](#) [SMBJ8.0A](#) [SMLJ30CA-TP](#) [ESD112-B1-02EL](#)  
[E6327](#) [ESD119B1W01005E6327XTSA1](#) [ESD5V0J4-TP](#) [ESD5V0L1B02VH6327XTSA1](#) [ESD7451N2T5G](#) [19180-510](#) [CPDT-5V0USP-HF](#)  
[3.0SMCJ33CA-F](#) [3.0SMCJ36A-F](#) [HSPC16701B02TP](#) [D3V3Q1B2DLP3-7](#) [D55V0M1B2WS-7](#) [DESD5V0U1BL-7B](#) [DRTR5V0U4SL-7](#)  
[SCM1293A-04SO](#) [ESD203-B1-02EL](#) [E6327](#) [SM12-7](#) [SMF8.0A-TP](#) [SMLJ45CA-TP](#) [CEN955 W/DATA](#) [82350120560](#) [82356240030](#)  
[VESD12A1A-HD1-GS08](#) [CPDUR5V0R-HF](#) [CPDUR24V-HF](#) [CPDQC5V0U-HF](#) [CPDQC5V0USP-HF](#) [CPDQC5V0-HF](#) [D1213A-01LP4-7B](#)  
[D1213A-02WL-7](#) [ESDLIN1524BJ-HQ](#) [5KP100A](#)