

SMALL SIGNAL COMPLEMENTARY PRE-BIASED DUAL TRANSISTOR
Features

- Epitaxial Planar Die Construction
- Built-In Biasing Resistors
- Surface Mount Package Suited for Automated Assembly
- **Totally Lead-Free & Fully RoHS Compliant (Notes 1 & 2)**
- **Halogen and Antimony Free. "Green" Device (Note 3)**
- **Qualified to AEC-Q101 Standards for High Reliability**
- **PPAP Capable (Note 4)**

Mechanical Data

- Case: SOT363
- Case Material: Molded Plastic, "Green" Molding Compound; UL Flammability Classification Rating 94V-0
- Moisture Sensitivity: Level 1 per J-STD-020
- Terminals: Finish – Matte Tin Plated Leads, Solderable per MIL-STD-202, Method 208 ③
- Weight: 0.006 grams (Approximate)

Part Number	R1(NOM)	R2(NOM)
DCX124EU	22kΩ	22kΩ
DCX144EU	47kΩ	47kΩ
DCX114YU	10kΩ	47kΩ
DCX123JU	2.2kΩ	47kΩ
DCX114EU	10kΩ	10kΩ
DCX143EU	4.7kΩ	4.7kΩ
DCX143ZU	4.7kΩ	47kΩ
DCX115EU	100kΩ	100kΩ

Part Number	R1 Only
DCX143TU	4.7kΩ
DCX114TU	10kΩ

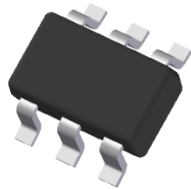
SOT363

Top View

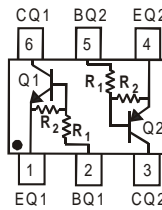

R1, R2

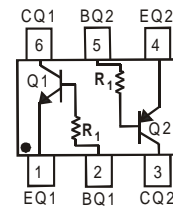

R1 Only

Device Schematic

Ordering Information (Notes 4, 5 & 6)

Product	Status	Compliance	Marking	Reel Size (inches)	Tape Width (mm)	Quantity per Reel
DCX124EU-7-F	Active	AEC-Q101	C17	7	8	3,000
DCX124EUQ-7-F	NRND (Use ACX124EUQ)	Automotive	C17	7	8	3,000
DCX124EUQ-13-F	NRND (Use ACX124EUQ)	Automotive	C17	13	8	10,000
DCX124EUQ-13R-F	NRND (Use ACX124EUQ)	Automotive	C17	13	8	10,000
DCX144EU-7-F	Active	AEC-Q101	C20	7	8	3,000
DCX144EU-7R-F	Active	AEC-Q101	C20	7	8	3,000
DCX144EUQ-7-F	Active	Automotive	C20	7	8	3,000
DCX114YU-7-F	Active	AEC-Q101	C14	7	8	3,000
DCX114YUQ-7-F	NRND (Use ACX114YUQ)	Automotive	C14	7	8	3,000
DCX114YUQ-13-F	NRND (Use ACX114YUQ)	Automotive	C14	13	8	10,000
DCX114YUQ-13R-F	NRND (Use ACX114YUQ)	Automotive	C14	13	8	10,000
DCX123JU-7-F	Active	AEC-Q101	C06	7	8	3,000
DCX123JUQ-7-F	Active	Automotive	C06	7	8	3,000
DCX114EU-7-F	Active	AEC-Q101	C13	7	8	3,000
DCX114EU-13R-F	Active	AEC-Q101	C13	13	8	10,000
DCX114EUQ-7-F	NRND (Use ACX114EUQ)	Automotive	C13	7	8	3,000
DCX114EUQ-13-F	NRND (Use ACX114EUQ)	Automotive	C13	13	8	10,000
DCX114EUQ-13R-F	NRND (Use ACX114EUQ)	Automotive	C13	13	8	10,000
DCX143TU-7-F	Active	AEC-Q101	C07	7	8	3,000
DCX143EU-7-F	Active	AEC-Q101	C08	7	8	3,000
DCX114TU-7-F	Active	AEC-Q101	C12	7	8	3,000
DCX143ZU-7-F	Active	AEC-Q101	C02	7	8	3,000
DCX115EU-7-F	Active	AEC-Q101	C01	7	8	3,000

- Notes:
1. No purposely added lead. Fully EU Directive 2002/95/EC (RoHS), 2011/65/EU (RoHS 2) & 2015/863/EU (RoHS 3) compliant.
 2. See <https://www.diodes.com/quality/lead-free/> for more information about Diodes Incorporated's definitions of Halogen- and Antimony-free, "Green" and Lead-free.
 3. Halogen- and Antimony-free "Green" products are defined as those which contain <900ppm bromine, <900ppm chlorine (<1500ppm total Br + Cl) and <1000ppm antimony compounds.
 4. Automotive products are AEC-Q101 qualified and are PPAP capable. Automotive, AEC-Q101 and standard products are electrically and thermally the same, except where specified. For more information, please refer to <http://www.diodes.com/quality/>.
 5. -7R and -13R are parts rotated in the pocket tape by +180°. For packaging details, go to our website at <https://www.diodes.com/design/support/packaging/diodes-packaging/>.
 6. NRND = Not Recommended for New Design.

Marking Information

SOT363

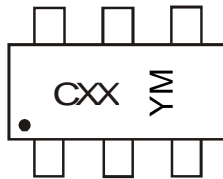

CXX = Product Type Marking Code
 YM = Date Code Marking
 Y = Year (ex: F = 2018)
 M = Month (ex: 9 = September)

Date Code Key

Year	2018	2019	2020	2021	2022	2023	2024	2025	2026	2027	2028
Code	F	G	H	I	J	K	L	M	N	O	P

Month	Jan	Feb	Mar	Apr	May	Jun	Jul	Aug	Sep	Oct	Nov	Dec
Code	1	2	3	4	5	6	7	8	9	O	N	D

Absolute Maximum Ratings NPN Section (@T_A = +25°C, unless otherwise specified.)

Characteristic	Symbol	Value	Unit
Supply Voltage <Pin: (6) to (1)>	V _{CC}	50	V
Input Voltage <Pin: (2) to (1)>	V _{IN}	DCX124EU	-10 to +40
		DCX144EU	-10 to +40
		DCX114YU	-6 to +40
		DCX123JU	-5 to +12
		DCX114EU	-10 to +40
		DCX143TU	-5V Max
		DCX143EU	-10 to +30
		DCX114TU	-5V Max
		DCX143ZU	-10 to +30
DCX115EU	-10 to +40		
Output Current	I _O	DCX124EU	30
		DCX144EU	30
		DCX114YU	70
		DCX123JU	100
		DCX114EU	50
		DCX143TU	100
		DCX143EU	100
		DCX114TU	100
		DCX143ZU	100
DCX115EU	20		
Output Current	I _C (Max)	100	mA

Absolute Maximum Ratings PNP Section (@T_A = +25°C, unless otherwise specified.)

Characteristic		Symbol	Value	Unit
Supply Voltage <Pin: (4) to (3)>		V _{CC}	50	V
Input Voltage <Pin: (5) to (4)>	DCX124EU	V _{IN}	+10 to -40	V
	DCX144EU		+10 to -40	
	DCX114YU		+6 to -40	
	DCX123JU		+5 to -12	
	DCX114EU		+10 to -40	
	DCX143TU		+5V Max	
	DCX143EU		+10 to -30	
	DCX114TU		+5V Max	
	DCX143ZU		+5 to -30	
DCX115EU	+10 to -40			
Output Current	DCX124EU	I _O	-30	mA
	DCX144EU		-30	
	DCX114YU		-70	
	DCX123JU		-100	
	DCX114EU		-50	
	DCX143TU		-100	
	DCX143EU		-100	
	DCX114TU		-100	
	DCX143ZU		-100	
DCX115EU	-20			
Output Current	I _C (Max)	-100	mA	

Thermal Characteristics (@T_A = +25°C, unless otherwise specified.)

Characteristic	Symbol	Value	Unit
Power Dissipation (Notes 7 & 8)	P _D	200	mW
Thermal Resistance, Junction to Ambient Air (Note 7)	R _{θJA}	625	°C/W
Operating and Storage Temperature Range	T _J , T _{STG}	-55 to +150	°C

- Notes:
7. Mounted on FR-4 PC Board with minimum recommended pad layout.
 8. 150mW per element must not be exceeded.

Electrical Characteristics NPN Section (@T_A = +25°C, unless otherwise specified.)

Characteristic		Symbol	Min	Typ	Max	Unit	Test Condition	
R1 Only (DCX143TU & DCX114TU)								
Collector-Base Breakdown Voltage		BV _{CBO}	50	—	—	V	I _C = 50μA	
Collector-Emitter Breakdown Voltage		BV _{CEO}	50	—	—	V	I _C = 1mA	
Emitter-Base Breakdown Voltage		BV _{EBO}	5	—	—	V	I _E = 50μA	
Collector Cutoff Current		I _{CBO}	—	—	0.5	μA	V _{CB} = 50V	
Emitter Cutoff Current		I _{EBO}	—	—	0.5	μA	V _{EB} = 4V	
Collector-Emitter Saturation Voltage		V _{CE(SAT)}	—	—	0.3	V	I _C /I _B = 2.5mA / 0.25mA DCX143TU I _C /I _B = 1mA / 0.1mA DCX114TU	
DC Current Transfer Ratio		h _{FE}	100	250	600	—	I _C = 1mA, V _{CE} = 5V	
Input Resistor (R ₁) Tolerance		ΔR ₁	-30	—	+30	%	—	
Gain-Bandwidth Product		f _T	—	250	—	MHz	V _{CE} = 10V, I _E = -5mA, f = 100MHz	
R1/R2 Only								
Input Voltage	DCX124EU	V _{I(OFF)}	0.5	1.1	—	V	V _{CC} = 5V, I _O = 100μA	
	DCX144EU		0.5	1.1				
	DCX114YU		0.3	—				
	DCX123JU		0.5	—				
	DCX114EU		0.5	1.1				
	DCX143EU		0.5	1.16				
	DCX143ZU		0.5	—				
	DCX115EU		0.5	—				
	DCX124EU	V _{I(ON)}	—	1.9	3.0	V	V _O = 0.3V, I _O = 5mA	
	DCX144EU		—	1.9	3.0		V _O = 0.3V, I _O = 2mA	
	DCX114YU		—	—	1.4		V _O = 0.3V, I _O = 1mA	
	DCX123JU		—	—	1.1		V _O = 0.3V, I _O = 5mA	
	DCX114EU		—	1.9	3.0		V _O = 0.3V, I _O = 10mA	
	DCX143EU		—	1.99	3.0		V _O = 0.3V, I _O = 20mA	
	DCX143ZU		—	—	1.3		V _O = 0.3V, I _O = 5mA	
	DCX115EU		—	—	3		V _O = 0.3V, I _O = 1mA	
Output Voltage	DCX124EU	V _{O(ON)}	—	0.1	0.3	V	I _O /I _I = 10mA / 0.5mA	
	DCX144EU						I _O /I _I = 10mA / 0.5mA	
	DCX114YU						I _O /I _I = 5mA / 0.25mA	
	DCX123JU						I _O /I _I = 5mA / 0.25mA	
	DCX114EU						I _O /I _I = 10mA / 0.5mA	
	DCX143EU						I _O /I _I = 10mA / 0.5mA	
	DCX143ZU						I _O /I _I = 5mA / 0.25mA	
	DCX115EU						I _O /I _I = 10mA / 0.5mA	
Input Current	DCX124EU	I _I	—	—	0.36	mA	V _I = 5V	
	DCX144EU							0.18
	DCX114YU							0.88
	DCX123JU							3.6
	DCX114EU							0.88
	DCX143EU							0.88
	DCX143ZU							1.8
	DCX115EU							0.15
Output Current		I _{O(OFF)}	—	—	0.5	μA	V _{CC} = 50V, V _I = 0V	
DC Current Gain	DCX124EU	G _i	56	—	—	—	V _O = 5V, I _O = 5mA	
	DCX124EUQ						60	V _O = 5V, I _O = 5mA
	DCX144EU						68	V _O = 5V, I _O = 5mA
	DCX114YU						68	V _O = 5V, I _O = 10mA
	DCX114YUQ						80	V _O = 5V, I _O = 10mA
	DCX123JU						80	V _O = 5V, I _O = 10mA
	DCX114EU						30	V _O = 5V, I _O = 5mA
	DCX143EU						50	V _O = 5V, I _O = 10mA
	DCX143ZU						80	V _O = 5V, I _O = 10mA
DCX115EU	82	V _O = 5V, I _O = 5mA						
Input Resistor (R ₁) Tolerance		ΔR ₁	-30	—	+30	%	—	
Resistance Ratio Tolerance		ΔR ₂ /R ₁	-20	—	+20	%	—	
Gain-Bandwidth Product		f _T	—	250	—	MHz	V _{CE} = 10V, I _E = 5mA, f = 100MHz	

Electrical Characteristics PNP Section (@T_A = +25°C, unless otherwise specified.)

Characteristic		Symbol	Min	Typ	Max	Unit	Test Condition	
R1 Only (DCX143TU & DCX114TU)								
Collector-Base Breakdown Voltage		BV _{CBO}	-50	—	—	V	I _C = -50μA	
Collector-Emitter Breakdown Voltage		BV _{CEO}	-50	—	—	V	I _C = -1mA	
Emitter-Base Breakdown Voltage		BV _{EBO}	-5	—	—	V	I _E = -50μA	
Collector Cutoff Current		I _{CBO}	—	—	-0.5	μA	V _{CB} = -50V	
Emitter Cutoff Current		I _{EBO}	—	—	-0.5	μA	V _{EB} = -4V	
Collector-Emitter Saturation Voltage		V _{CE(SAT)}	—	—	-0.3	V	I _C /I _B = 2.5mA / 0.25mA DCX143TU I _C /I _B = 1mA / 0.1mA DCX114TU	
DC Current Transfer Ratio		h _{FE}	100	250	600	—	I _C = -1mA, V _{CE} = -5V	
Input Resistor (R ₁) Tolerance		ΔR ₁	-30	—	+30	%	—	
Gain-Bandwidth Product		f _T	—	250	—	MHz	V _{CE} = -10V, I _E = 5mA, f = 100MHz	
R1/R2 Only								
Input Voltage	DCX124EU	V _{I(OFF)}	-0.5	-1.1	—	V	V _{CC} = -5V, I _O = -100μA	
	DCX144EU		-0.5	-1.1				
	DCX114YU		-0.3	—				
	DCX123JU		-0.5	—				
	DCX114EU		-0.5	-1.1				
	DCX143EU		-0.5	-1.16				
	DCX143ZU		-0.5	—				
	DCX115EU		-0.5	—				
	DCX124EU	V _{I(ON)}	—	-1.9	-3.0	V	V _O = -0.3V, I _O = -5mA	
	DCX144EU		—	-1.9	-3.0		V _O = -0.3V, I _O = -2mA	
	DCX114YU		—	—	-1.4		V _O = -0.3V, I _O = -1mA	
	DCX123JU		—	—	-1.1		V _O = -0.3V, I _O = -5mA	
	DCX114EU		—	-1.9	-3.0		V _O = -0.3V, I _O = -10mA	
	DCX143EU		—	-2.5	-3.0		V _O = -0.3V, I _O = -20mA	
	DCX143ZU		—	—	-1.3		V _O = -0.3V, I _O = -5mA	
	DCX115EU		—	—	-3		V _O = -0.3V, I _O = -1mA	
	Output Voltage	DCX124EU	V _{O(ON)}	—	-0.1	-0.3	V	I _O /I _I = -10mA / -0.5mA
DCX144EU		I _O /I _I = -10mA / -0.5mA						
DCX114YU		I _O /I _I = -5mA / -0.25mA						
DCX123JU		I _O /I _I = -5mA / -0.25mA						
DCX114EU		I _O /I _I = -10mA / -0.5mA						
DCX143EU		I _O /I _I = -10mA / -0.5mA						
DCX143ZU		I _O /I _I = -5mA / -0.25mA						
DCX115EU	I _O /I _I = -10mA / -0.5mA							
Input Current	DCX124EU	I _I	—	—	-0.36	mA	V _I = -5V	
	DCX144EU							-0.18
	DCX114YU							-0.88
	DCX123JU							-3.6
	DCX114EU							-0.88
	DCX143EU							-0.88
	DCX143ZU							-1.8
DCX115EU	-0.15							
Output Current		I _{O(OFF)}	—	—	-0.5	μA	V _{CC} = 50V, V _I = 0V	
DC Current Gain	DCX124EU	G _I	—	—	—	—	V _O = -5V, I _O = -5mA	
	DCX124EUQ						56	V _O = -5V, I _O = -5mA
	DCX144EU						60	V _O = -5V, I _O = -5mA
	DCX114YU						68	V _O = -5V, I _O = -5mA
	DCX114YUQ						68	V _O = -5V, I _O = -10mA
	DCX123JU						80	V _O = -5V, I _O = -10mA
	DCX114EU						80	V _O = -5V, I _O = -10mA
	DCX143EU						30	V _O = -5V, I _O = -5mA
	DCX143ZU						40	V _O = -5V, I _O = -10mA
DCX115EU	80	V _O = -5V, I _O = -10mA						
DCX115EU	82	V _O = -5V, I _O = -5mA						
Input Resistor (R ₁) Tolerance		ΔR ₁	-30	—	+30	%	—	
Resistance Ratio Tolerance		ΔR ₂ /R ₁	-20	—	+20	%	—	
Gain-Bandwidth Product		f _T	—	250	—	MHz	V _{CE} = -10V, I _E = -5mA, f = 100MHz	

Typical Curves – Total Device

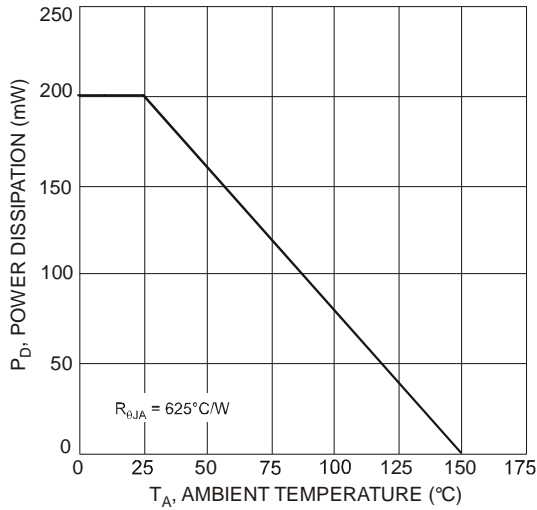

Fig. 1 Power Derating Curve

Typical Curves – DCX123JU PNP Section (@T_A = +25°C, unless otherwise specified.)

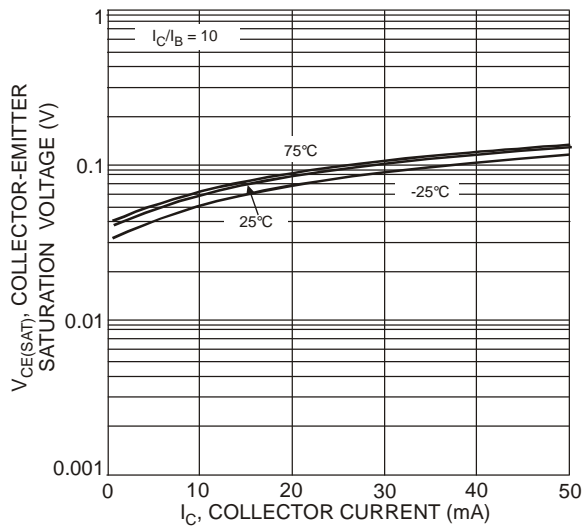

Fig. 2 Typical V_{CE(SAT)} vs. I_C

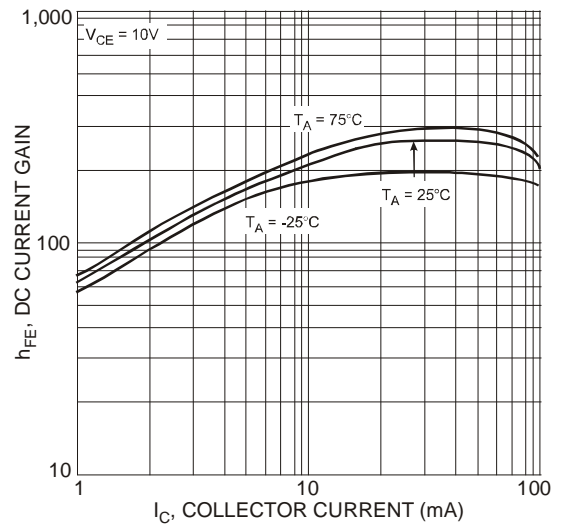

Fig. 3 Typical DC Current Gain

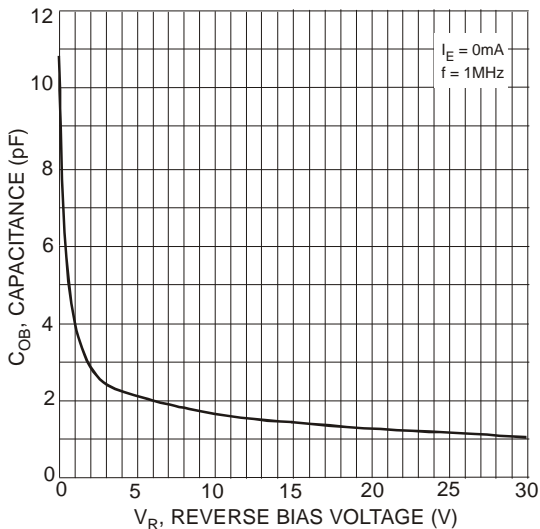

Fig. 4 Typical Output Capacitance

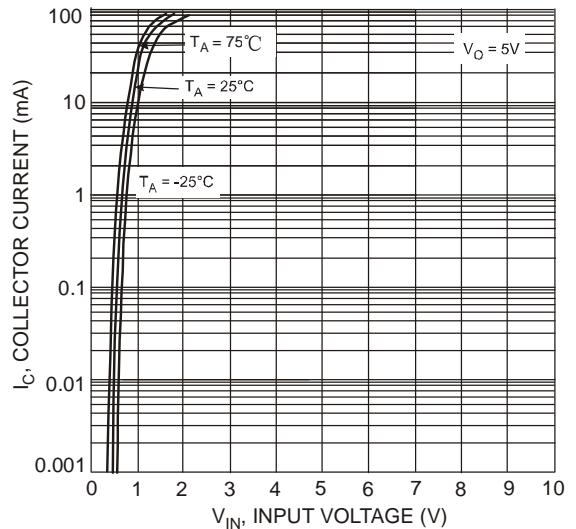

Fig. 5 Typical Collector Current vs. Input Voltage

Typical Curves – DCX123JU PNP Section (Cont.)

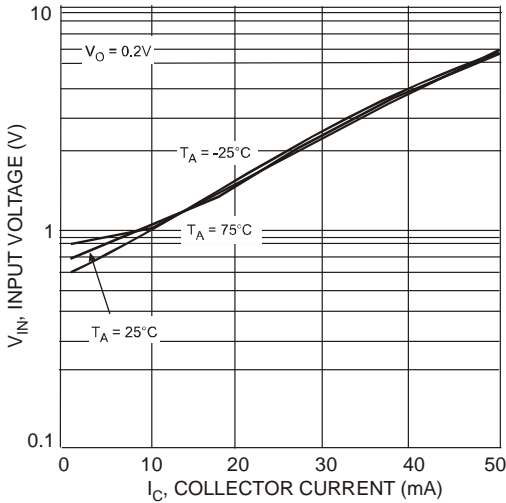

Fig. 6 Typical Input Voltage vs. Collector Current

Typical Curves – DCX123JU NPN Section (@T_A = +25°C, unless otherwise specified.)

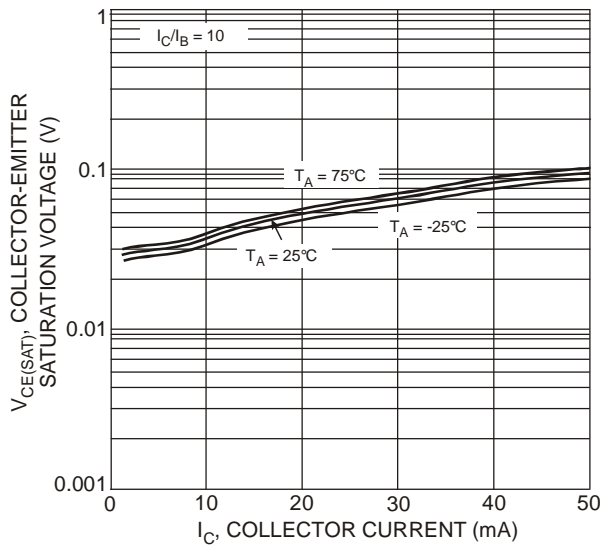

Fig. 7 Typical V_{CE(SAT)} vs. I_C

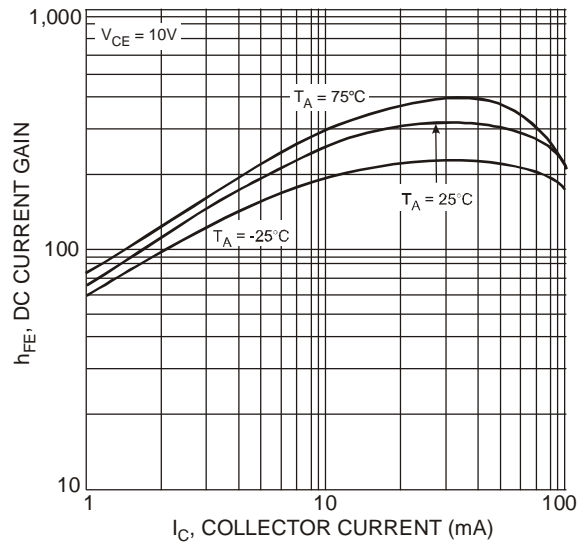

Fig. 8 Typical DC Current Gain

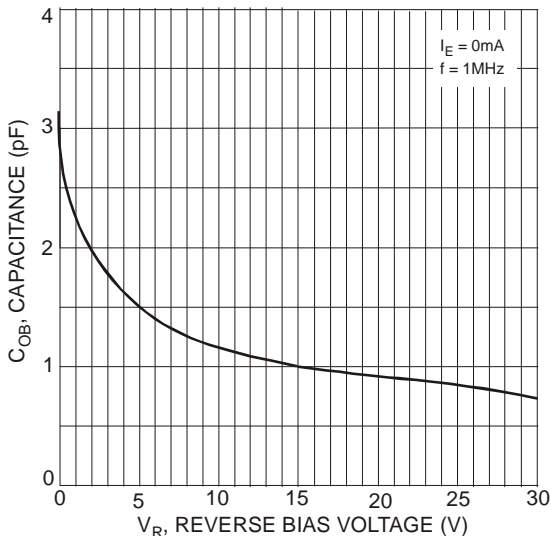

Fig. 9 Typical Output Capacitance

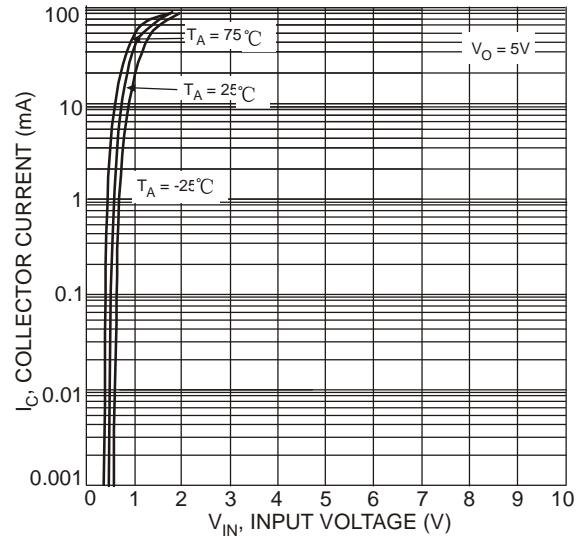

Fig. 10 Typical Collector Current vs. Input Voltage

Typical Curves – DCX123JU NPN Section (Cont.)

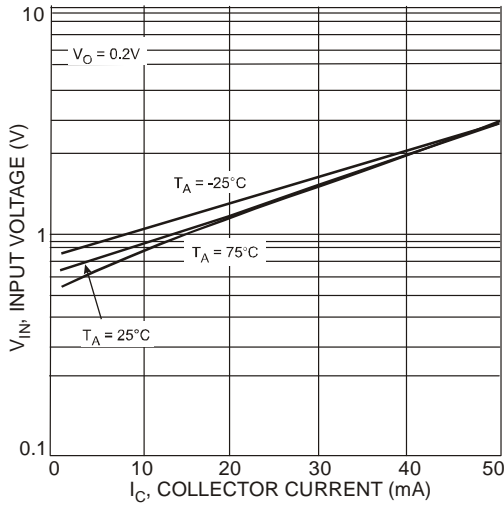

Fig. 11 Typical Input Voltage vs. Collector Current

Typical Curves – DCX143EU PNP Section (@T_A = +25°C, unless otherwise specified.)

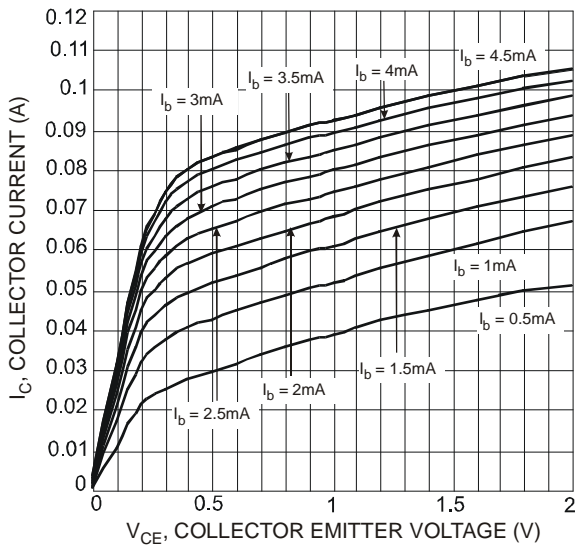

Fig. 12 Typical V_{CE} vs. I_C

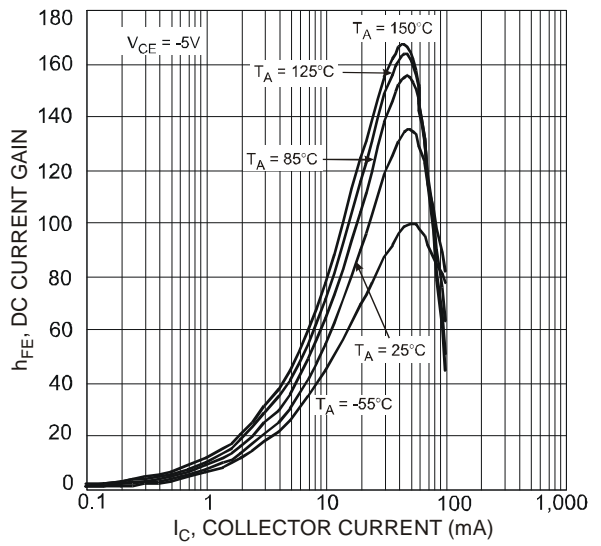

Fig. 13 Typical DC Current Gain

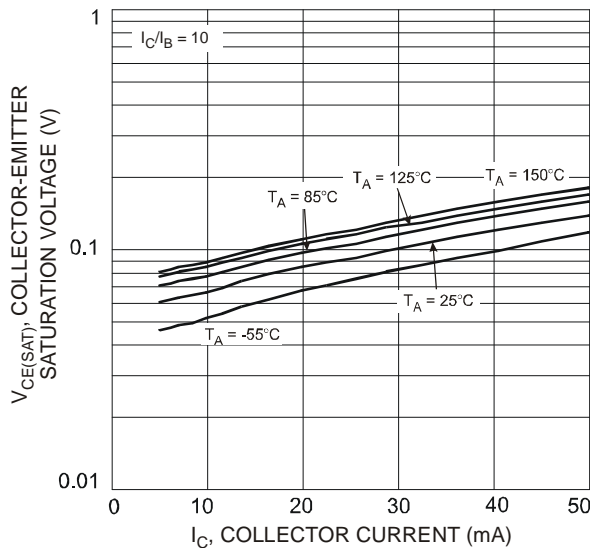

Fig. 14 Typical V_{CE(SAT)} vs. I_C

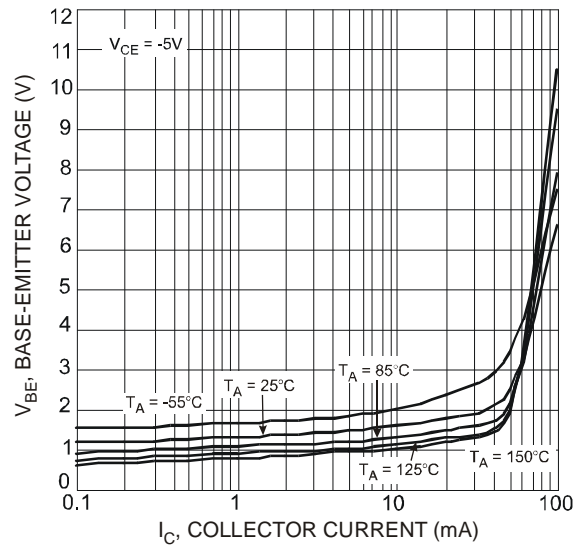

Fig. 15 Typical V_{BE} vs. I_C

Typical Curves – DCX143EU PNP Section (Cont.)

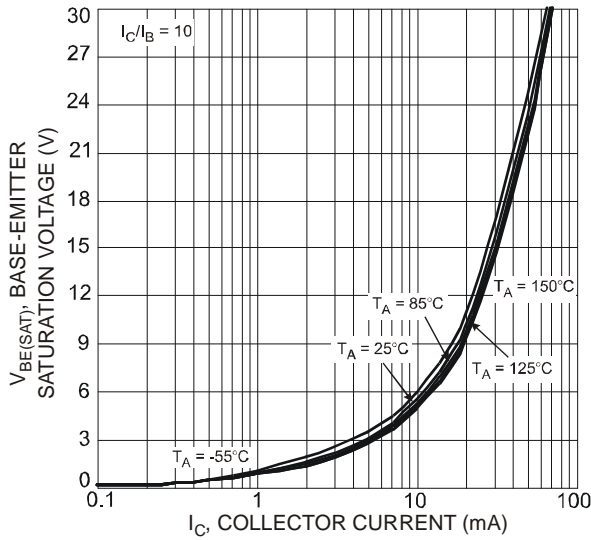

Fig. 16 Typical $V_{BE(SAT)}$ vs. I_C

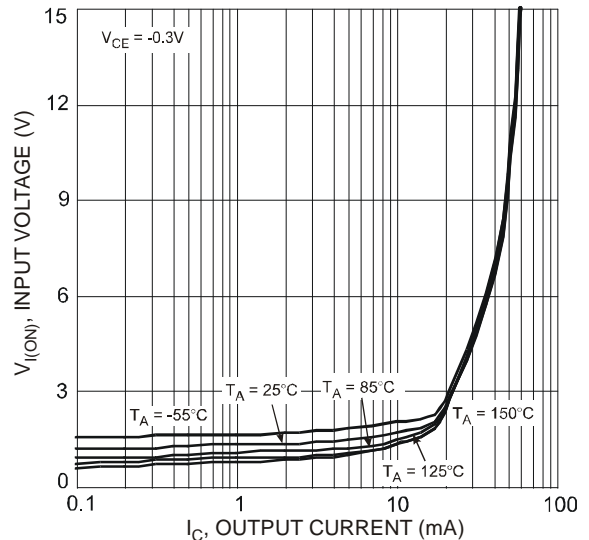

Fig. 17 Typical $V_{I(ON)}$ vs. I_C

Typical Curves – DCX143EU NPN Section (@ $T_A = +25^\circ\text{C}$, unless otherwise specified.)

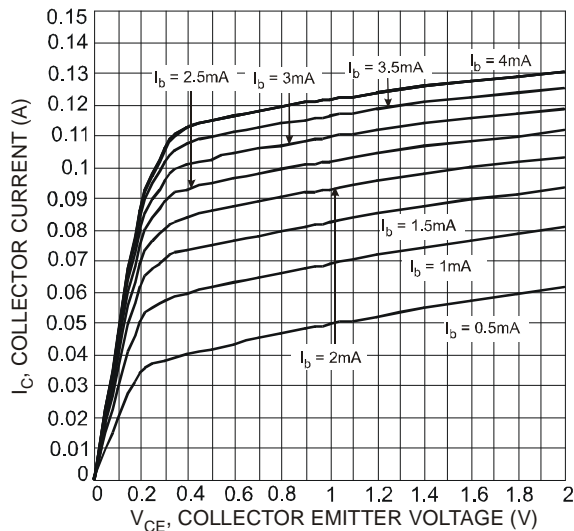

Fig. 18 Typical V_{CE} vs. I_C

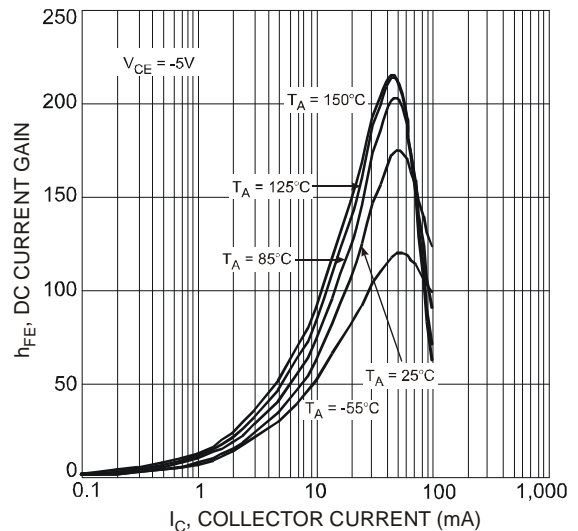

Fig. 19 Typical DC Current Gain

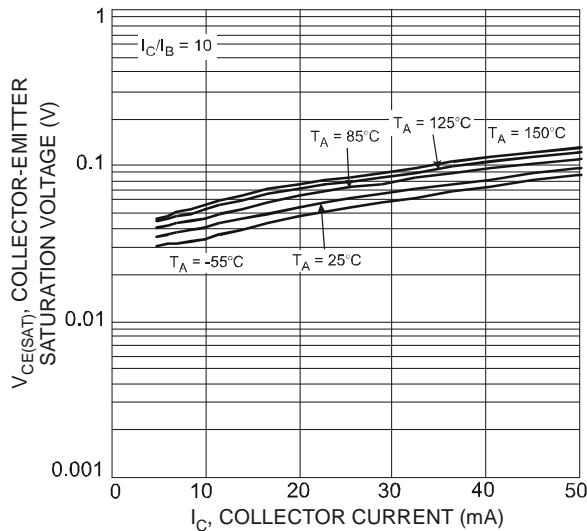

Fig. 20 Typical $V_{CE(SAT)}$ vs. I_C

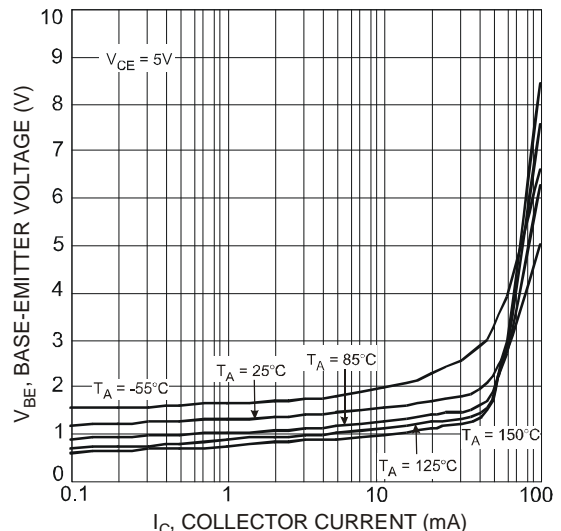

Fig. 21 Typical V_{BE} vs. I_C

Typical Curves – DCX143EU NPN Section (Cont.)

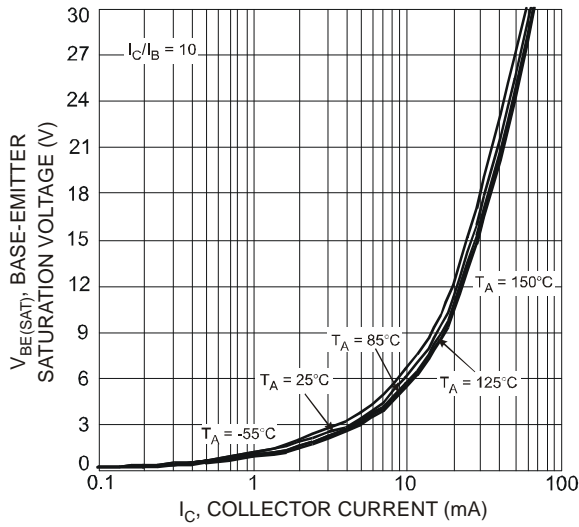

Fig. 22 Typical $V_{BE(SAT)}$ vs. I_C

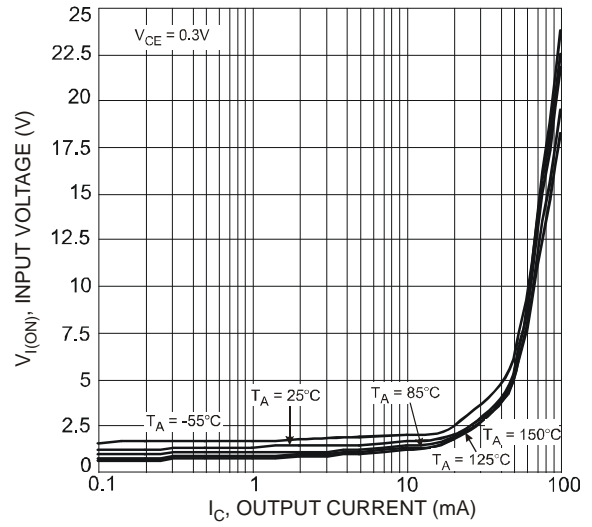

Fig. 23 Typical $V_{I(ON)}$ vs. I_C

Typical Curves – DCX114TU PNP Section (@ $T_A = +25^\circ\text{C}$, unless otherwise specified.)

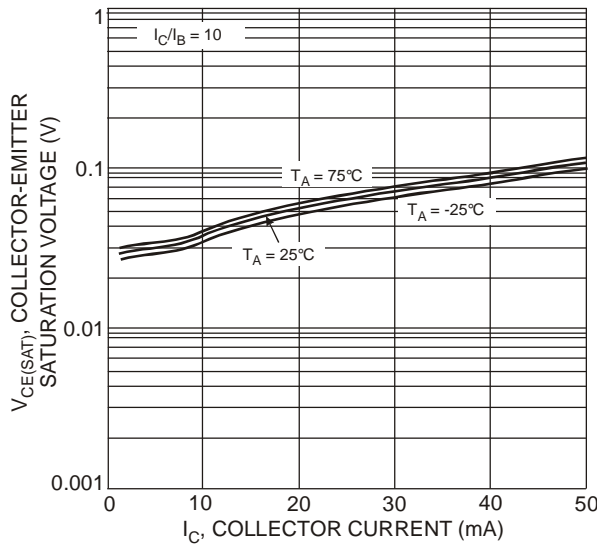

Fig. 24 Typical $V_{CE(SAT)}$ vs. I_C

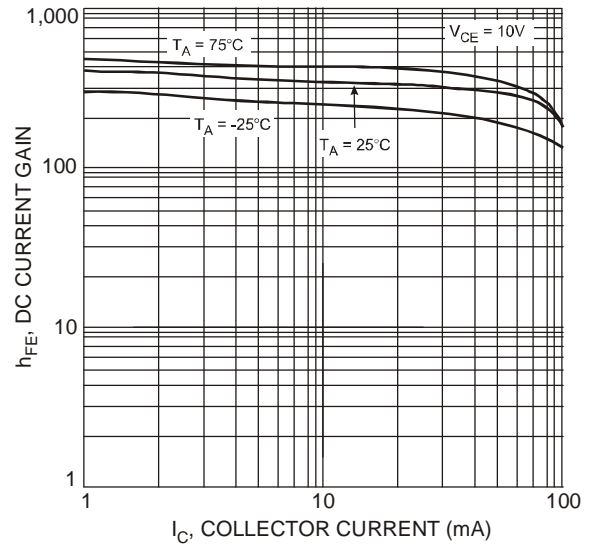

Fig. 25 Typical DC Current Gain

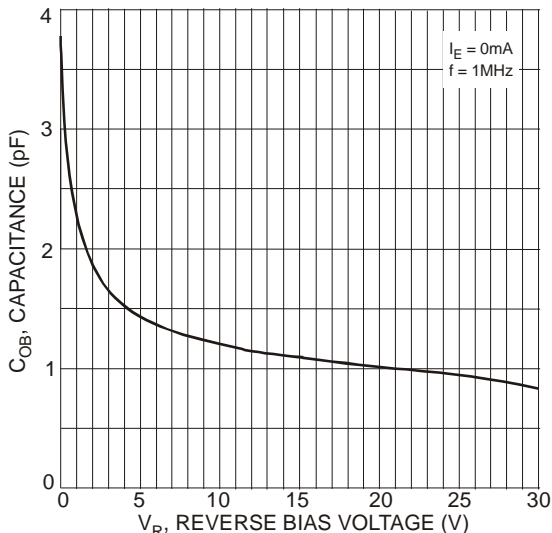

Fig. 26 Typical Output Capacitance

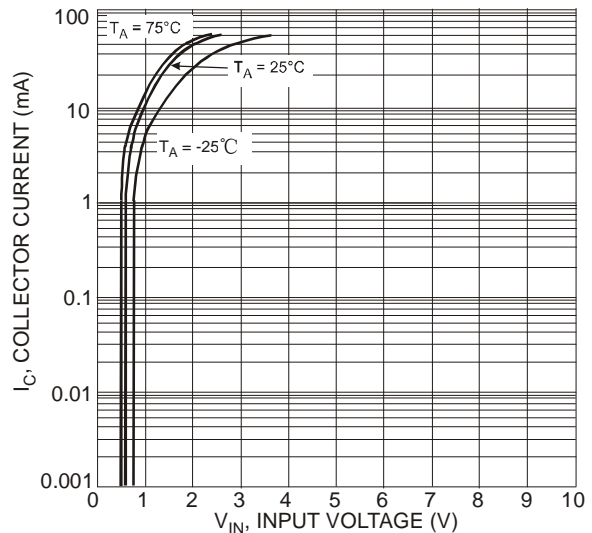

Fig. 27 Typical Collector Current vs. Input Voltage

Typical Curves – DCX114TU PNP Section (Cont.)

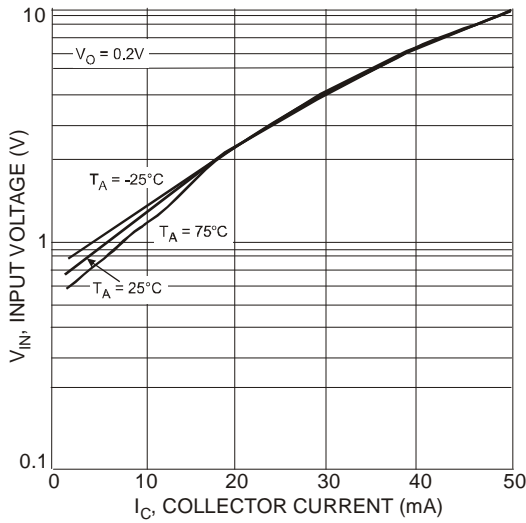

Fig. 28 Typical Input Voltage vs. Collector Current

Typical Curves – DCX114TU NPN Section (@ $T_A = +25^\circ\text{C}$, unless otherwise specified.)

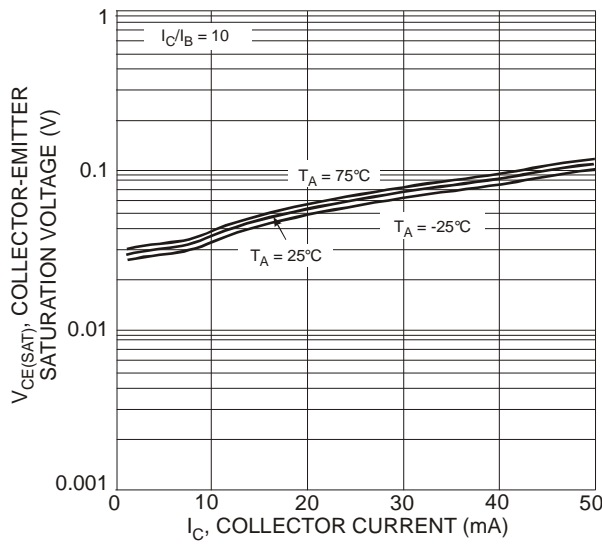

Fig. 29 Typical $V_{CE(SAT)}$ vs. I_C

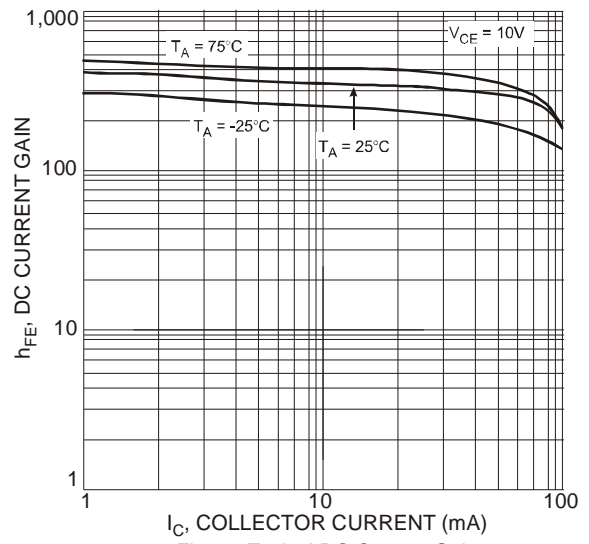

Fig. 30 Typical DC Current Gain

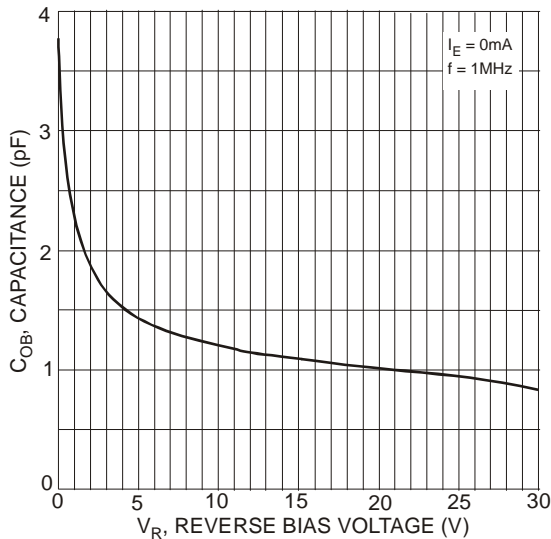

Fig. 31 Typical Output Capacitance

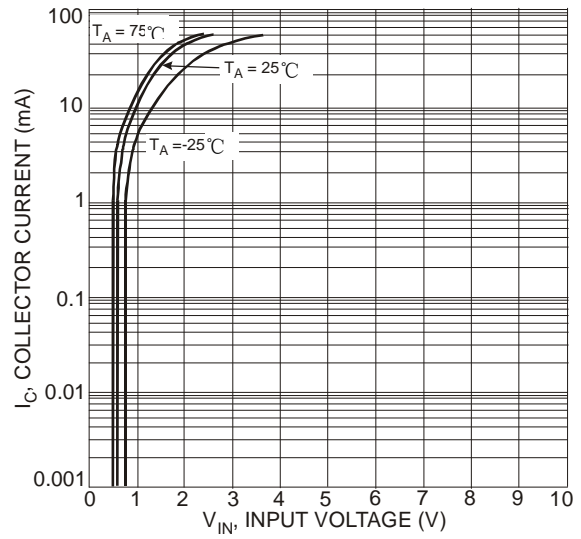

Fig. 32 Typical Collector Current vs. Input Voltage

Typical Curves – DCX114TU NPN Section (Cont.)

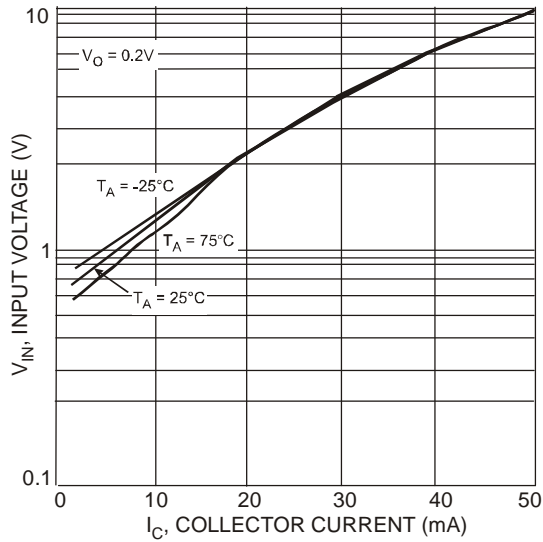
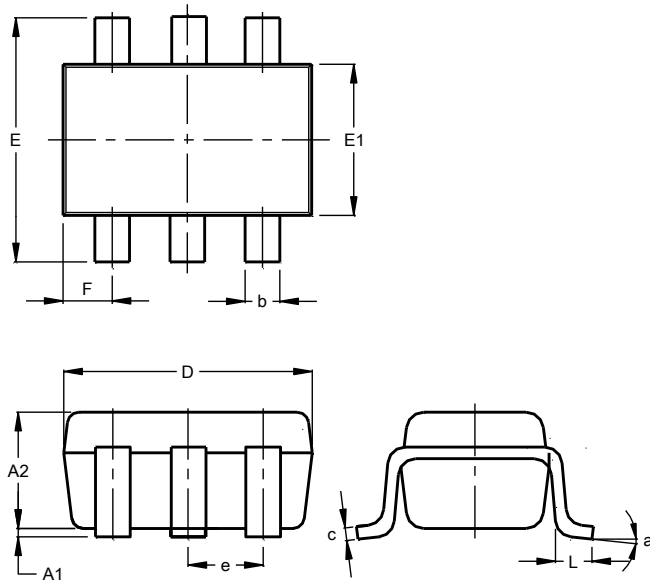

Fig. 33 Typical Input Voltage vs. Collector Current

Package Outline Dimensions

Please see <http://www.diodes.com/package-outlines.html> for the latest version.

SOT363



SOT363			
Dim	Min	Max	Typ
A1	0.00	0.10	0.05
A2	0.90	1.00	0.95
b	0.10	0.30	0.25
c	0.10	0.22	0.11
D	1.80	2.20	2.15
E	2.00	2.20	2.10
E1	1.15	1.35	1.30
e	0.650 BSC		
F	0.40	0.45	0.425
L	0.25	0.40	0.30
a	0°	8°	--
All Dimensions in mm			

Suggested Pad Layout

Please see <http://www.diodes.com/package-outlines.html> for the latest version.

SOT363

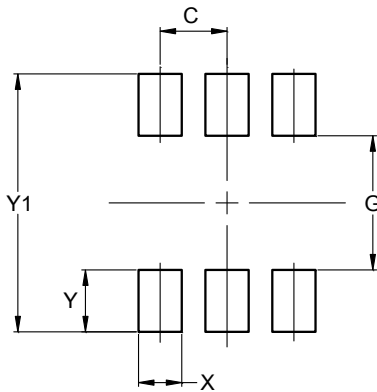

Dimensions	Value (in mm)
C	0.650
G	1.300
X	0.420
Y	0.600
Y1	2.500

IMPORTANT NOTICE

DIODES INCORPORATED MAKES NO WARRANTY OF ANY KIND, EXPRESS OR IMPLIED, WITH REGARDS TO THIS DOCUMENT, INCLUDING, BUT NOT LIMITED TO, THE IMPLIED WARRANTIES OF MERCHANTABILITY AND FITNESS FOR A PARTICULAR PURPOSE (AND THEIR EQUIVALENTS UNDER THE LAWS OF ANY JURISDICTION).

Diodes Incorporated and its subsidiaries reserve the right to make modifications, enhancements, improvements, corrections or other changes without further notice to this document and any product described herein. Diodes Incorporated does not assume any liability arising out of the application or use of this document or any product described herein; neither does Diodes Incorporated convey any license under its patent or trademark rights, nor the rights of others. Any Customer or user of this document or products described herein in such applications shall assume all risks of such use and will agree to hold Diodes Incorporated and all the companies whose products are represented on Diodes Incorporated website, harmless against all damages.

Diodes Incorporated does not warrant or accept any liability whatsoever in respect of any products purchased through unauthorized sales channel. Should Customers purchase or use Diodes Incorporated products for any unintended or unauthorized application, Customers shall indemnify and hold Diodes Incorporated and its representatives harmless against all claims, damages, expenses, and attorney fees arising out of, directly or indirectly, any claim of personal injury or death associated with such unintended or unauthorized application.

Products described herein may be covered by one or more United States, international or foreign patents pending. Product names and markings noted herein may also be covered by one or more United States, international or foreign trademarks.

This document is written in English but may be translated into multiple languages for reference. Only the English version of this document is the final and determinative format released by Diodes Incorporated.

LIFE SUPPORT

Diodes Incorporated products are specifically not authorized for use as critical components in life support devices or systems without the express written approval of the Chief Executive Officer of Diodes Incorporated. As used herein:

A. Life support devices or systems are devices or systems which:

1. are intended to implant into the body, or
2. support or sustain life and whose failure to perform when properly used in accordance with instructions for use provided in the labeling can be reasonably expected to result in significant injury to the user.

B. A critical component is any component in a life support device or system whose failure to perform can be reasonably expected to cause the failure of the life support device or to affect its safety or effectiveness.

Customers represent that they have all necessary expertise in the safety and regulatory ramifications of their life support devices or systems, and acknowledge and agree that they are solely responsible for all legal, regulatory and safety-related requirements concerning their products and any use of Diodes Incorporated products in such safety-critical, life support devices or systems, notwithstanding any devices- or systems-related information or support that may be provided by Diodes Incorporated. Further, Customers must fully indemnify Diodes Incorporated and its representatives against any damages arising out of the use of Diodes Incorporated products in such safety-critical, life support devices or systems.

Copyright © 2018, Diodes Incorporated

www.diodes.com

X-ON Electronics

Largest Supplier of Electrical and Electronic Components

Click to view similar products for [Bipolar Transistors - Pre-Biased](#) *category:*

Click to view products by [Diodes Incorporated](#) *manufacturer:*

Other Similar products are found below :

[RN1607\(TE85L,F\)](#) [DTA124GKAT146](#) [DTA144WETL](#) [DTA144WKAT146](#) [DTC113EET1G](#) [DTC115TETL](#) [DTC115TKAT146](#)
[DTC124TETL](#) [DTC144ECA-TP](#) [DTC144VUAT106](#) [MUN5241T1G](#) [NSBA114TDP6T5G](#) [NSBA143ZF3T5G](#) [NSBC114YF3T5G](#)
[NSBC123TF3T5G](#) [SMUN5330DW1T1G](#) [SSVMUN5312DW1T2G](#) [RN1303\(TE85L,F\)](#) [RN4605\(TE85L,F\)](#) [TTEPROTOTYPE79](#)
[DDTC114EUAQ-7-F](#) [EMH15T2R](#) [SMUN2214T3G](#) [NSBC114TF3T5G](#) [NSBC143ZPDP6T5G](#) [NSVMUN5113DW1T3G](#)
[SMUN5230DW1T1G](#) [SMUN5133T1G](#) [SMUN2214T1G](#) [DTC114EUA-TP](#) [NSBA144EF3T5G](#) [NSVDTA114EET1G](#) [2SC2223-T1B-A](#)
[2SC3912-TB-E](#) [SMUN5237DW1T1G](#) [SMUN5213DW1T1G](#) [SMUN5114DW1T1G](#) [SMUN2111T1G](#) [NSVDTC144EM3T5G](#) [DTC124ECA-](#)
[TP](#) [DTC123TM3T5G](#) [DTA114ECA-TP](#) [DTA113EM3T5G](#) [DCX115EK-7-F](#) [DTC113EM3T5G](#) [NSVMUN5135DW1T1G](#)
[NSVDTC143ZM3T5G](#) [SMUN5216DW1T1G](#) [NSVMUN5312DW1T2G](#) [NSVMUN5215DW1T1G](#)