

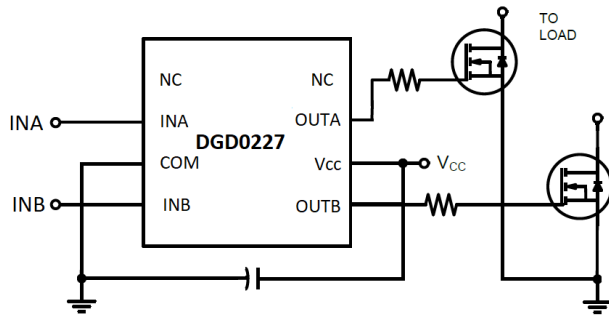
## Description

The DGD0227 dual, high-speed, low-side MOSFET and IGBT driver is capable of driving 4A of peak current. The DGD0227 logic inputs are compatible with standard TTL and CMOS levels (down to 3.3V) to interface easily with MCUs. Fast and well-matched propagation delays allow high-speed operation, enabling a smaller, more compact power-switching design using smaller associated components.

The DGD0227 is offered in the SO-8 (Type TH) package and operates over an extended -40°C to +125°C temperature range.

## Applications

- DC-DC Converters
- Line Drivers
- Motor Controls
- Switch Mode Power Supplies



Typical Configuration

## Features

- Efficient Low Cost Solution for Driving MOSFETs and IGBTs
- Wide Supply Voltage Operating Range: 4.5V to 18V
- 4.0A Source / 4.0A Sink Output Current Capability
- Fast Propagation Delay (35ns Typ)
- Fast Rise and Fall Times (20ns Typ)
- Logic Input (IN) 3.3V Capability
- Extended Temperature Range: -40°C to +125°C
- **Totally Lead-Free & Fully RoHS Compliant (Notes 1 & 2)**
- **Halogen and Antimony Free. "Green" Device (Note 3)**

## Mechanical Data

- Case: SO-8 (Type TH)
- Case Material: Molded Plastic. "Green" Molding Compound. UL Flammability Classification Rating 94V-0
- Moisture Sensitivity: Level 3 per J-STD-020
- Terminals: Finish – Matte Tin Plated Leads, Solderable per MIL-STD-202, Method 208 <sup>Ⓔ</sup>
- Weight: 0.075 grams (Approximate)



SO-8 (Type TH)  
Top View

## Ordering Information (Note 4)

Product	Marking	Reel Size (inches)	Tape Width (mm)	Quantity Per Reel
DGD0227S8-13	DGD0227	13	12	2,500

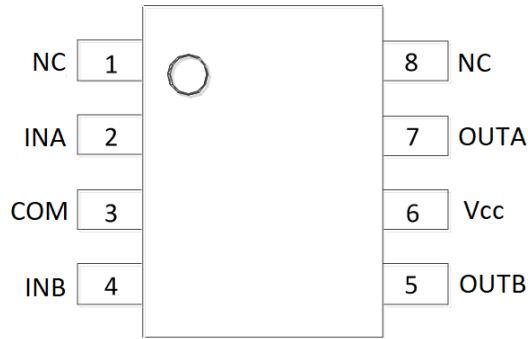
- Notes:
1. No purposely added lead. Fully EU Directive 2002/95/EC (RoHS), 2011/65/EU (RoHS 2) & 2015/863/EU (RoHS 3) compliant.
  2. See [http://www.diodes.com/quality/lead\\_free.html](http://www.diodes.com/quality/lead_free.html) for more information about Diodes Incorporated's definitions of Halogen- and Antimony-free, "Green" and Lead-free.
  3. Halogen- and Antimony-free "Green" products are defined as those which contain <900ppm bromine, <900ppm chlorine (<1500ppm total Br + Cl) and <1000ppm antimony compounds.
  4. For packaging details, go to our website at <http://www.diodes.com/products/packages.html>.

## Marking Information



Dii = Manufacturer's Marking  
 DGD0227 = Product Type Marking Code  
 YY = Year (ex: 18 = 2018)  
 WW = Week (01 to 53)

**Pin Diagrams**

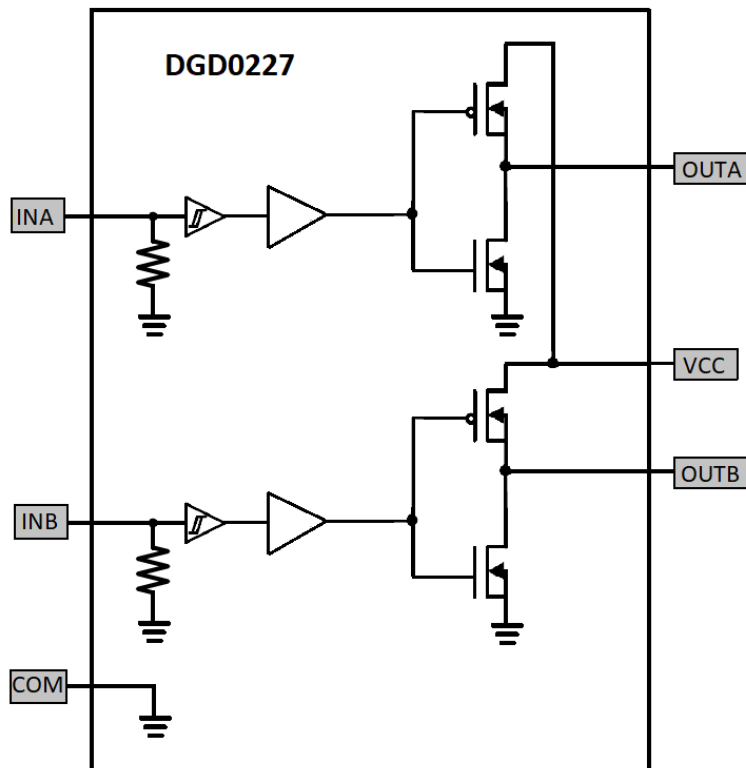


Top View: SO-8 (Type TH)

**Pin Descriptions**

Pin Number	Pin Name	Function
1, 8	NC	No Connection (No internal connection)
2	INA	Logic Input for A Phase, in Phase with OUTA
3	COM	Supply Return
4	INB	Logic Input for B Phase, in Phase with OUTB
5	OUTB	Gate Driver Output B Phase
6	V <sub>CC</sub>	Supply Input
7	OUTA	Gate Driver Output A Phase

**Functional Block Diagram**



### Absolute Maximum Ratings (@T<sub>A</sub> = +25°C, unless otherwise specified.)

Characteristic	Symbol	Value	Unit
Low-side Fixed Supply Voltage	V <sub>CC</sub>	-0.3 to +22	V
Output Voltage (OUTA, OUTB)	V <sub>OUT</sub>	-0.3 to V <sub>CC</sub> +0.3	V
Logic Input Voltage (INA, INB)	V <sub>IN</sub>	-0.3 to V <sub>CC</sub> +0.3	V

### Thermal Characteristics (@T<sub>A</sub> = +25°C, unless otherwise specified.)

Characteristic	Symbol	Value	Unit
Power Dissipation Linear Derating Factor (Note 5)	P <sub>D</sub>	0.625	W
Thermal Resistance, Junction to Ambient (Note 5)	R <sub>θJA</sub>	200	°C/W
Operating Temperature	T <sub>J</sub>	+150	°C
Storage Temperature Range	T <sub>STG</sub>	-55 to +150	

Note: 5. When mounted on a standard JEDEC 2-layer FR-4 board.

### ESD Ratings (Note 6)

Characteristic	Symbol	Value	Unit	JEDEC Class
Electrostatic Discharge - Human Body Model	ESD HBM	2,000	V	2
Electrostatic Discharge – Charge Device Model	ESD CDM	750	V	III

Note: 6. Refer to JEDEC specification JESD22-A114 and JESD22-C101.

### Recommended Operating Conditions

Parameter	Symbol	Min	Max	Unit
Supply Voltage	V <sub>CC</sub>	4.5	18	V
Output Voltage (OUTA/OUTB)	V <sub>OUT</sub>	0	V <sub>CC</sub>	V
Logic Input Voltage (INA, INB)	V <sub>IN</sub>	0	5	V
Ambient Temperature	T <sub>A</sub>	-40	+125	°C

**DC Electrical Characteristics** ( $V_{BIAS}$  (4.5V <  $V_{CC}$  < 18V), @ $T_A$  = +25°C, unless otherwise specified.) (Note 7)

Parameter	Symbol	Min	Typ	Max	Unit	Conditions
Logic "1" Input Voltage	$V_{IH}$	2.4	—	—	V	—
Logic "0" Input Voltage	$V_{IL}$	—	—	0.7	V	—
Logic "1" Input Bias Current	$I_{IH+}$	—	—	10	$\mu$ A	$V_{IN} = 3.3V$
Logic "0" Input Bias Current	$I_{IH-}$	—	—	10	$\mu$ A	$V_{IN} = 0V$
High Level Output Voltage, $V_{BIAS} - V_O$	$V_{OH}$	—	30	100	mV	$I_{OUT} = -10mA$
Low Level Output Voltage	$V_{OL}$	—	16	50	mV	$I_{OUT} = 10mA$
Quiescent $V_{CC}$ Supply Current	$I_{CCQ}$	—	40	100	$\mu$ A	$V_{IN} = 0V$ or 3.3V
Output High Short Circuit Pulsed Current	$I_{O+}$	—	4.0	—	A	$V_{CC} = 14V$
Output Low Short Circuit Pulsed Current	$I_{O-}$	—	4.0	—	A	$V_{CC} = 14V$
Output Resistance, High	$R_{OH}$	—	1.5	—	$\Omega$	$I_{OUT} = -10mA$ , $V_{CC} = 14V$
Output Resistance, Low	$R_{OL}$	—	1.0	—	$\Omega$	$I_{OUT} = 10mA$ , $V_{CC} = 14V$

Note: 7. The  $V_{IN}$  and  $I_{IN}$  parameters are applicable to the logic pins; INA and INB. The  $V_O$  and  $I_O$  parameters are applicable to the output pins: OUTA and OUTB.

**AC Electrical Characteristics** ( $V_{BIAS}$  (4.5V <  $V_{CC}$  < 18V),  $C_L = 1000pF$ , @ $T_A$  = +25°C, unless otherwise specified.)

Parameter	Symbol	Min	Typ	Max	Unit	Conditions
Turn-On Rise Time	$t_R$	—	20	40	ns	$V_{CC} = 14V$
Turn-Off Fall Time	$t_F$	—	20	40	ns	$V_{CC} = 14V$
Turn-On Propagation Delay	$t_{ON}$	—	40	100	ns	$V_{CC} = 14V$
Turn-Off Propagation Delay	$t_{OFF}$	—	35	50	ns	$V_{CC} = 14V$

## Timing Waveforms

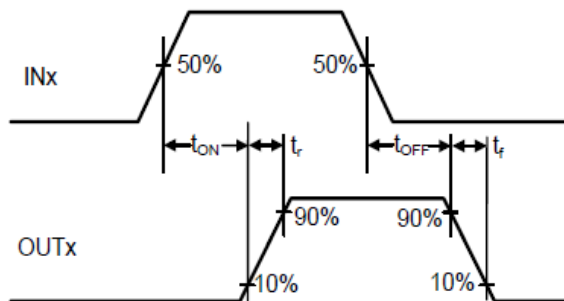
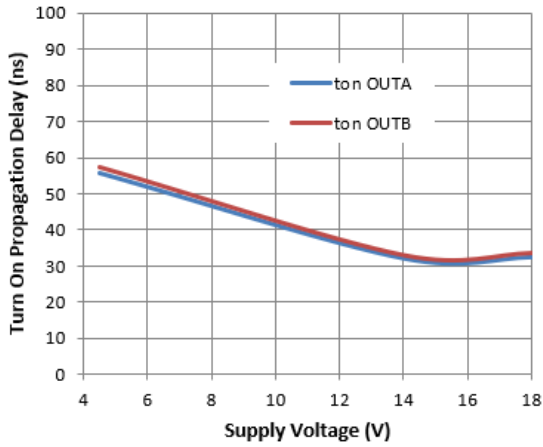
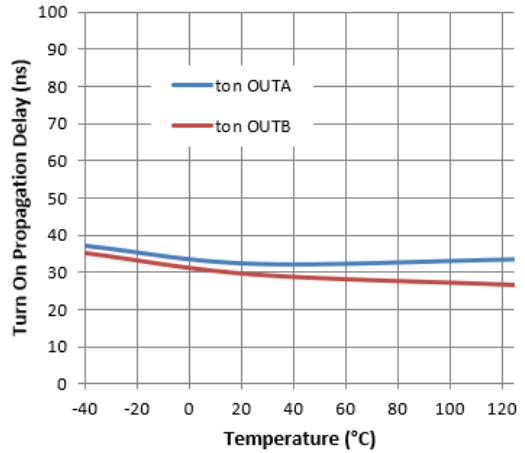


Figure 1. Switching Time Waveform Definitions

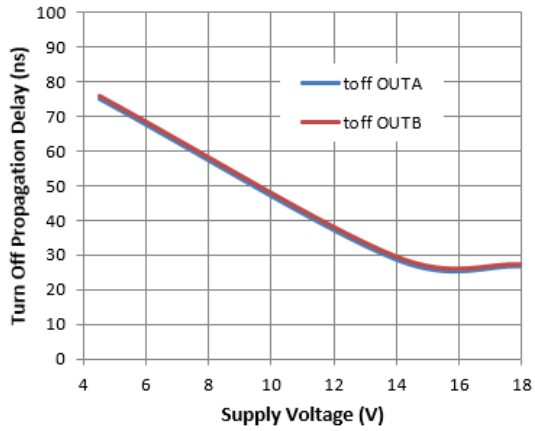
**Typical Performance Characteristics** (@T<sub>A</sub> = +25°C, unless otherwise specified.)



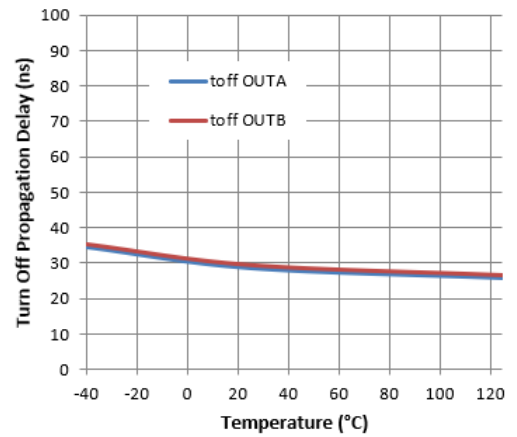
**Figure 4.** Turn-on Propagation Delay vs. Supply Voltage



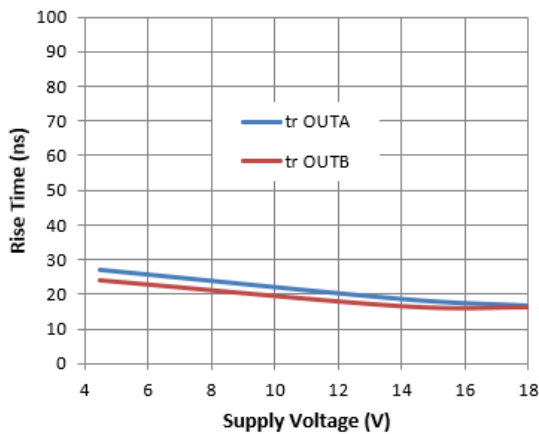
**Figure 5.** Turn-on Propagation Delay vs. Temperature



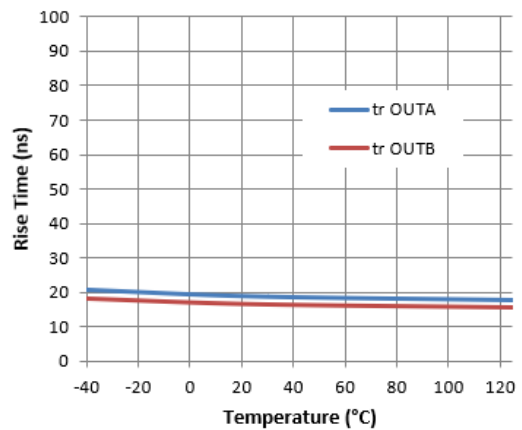
**Figure 6.** Turn-off Propagation Delay vs. Supply Voltage



**Figure 7.** Turn-off Propagation Delay vs. Temperature

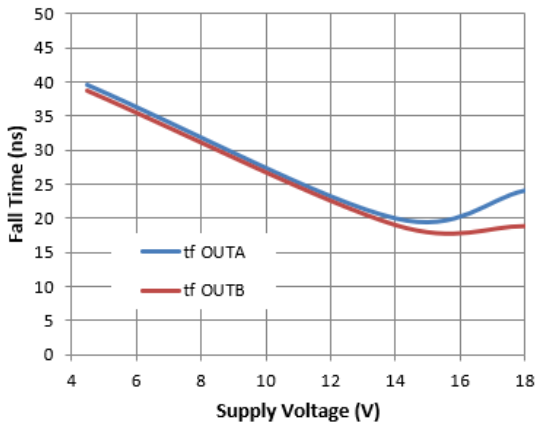


**Figure 8.** Rise Time vs. Supply Voltage

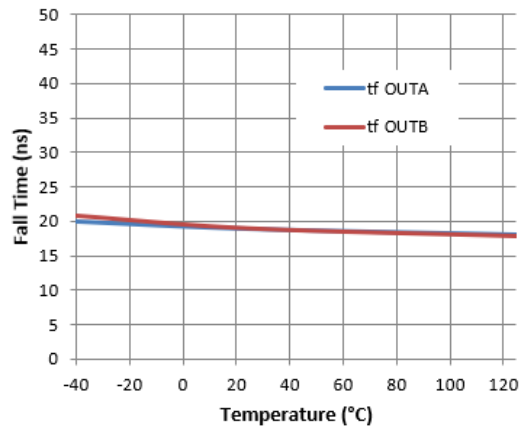


**Figure 9.** Rise Time vs. Temperature

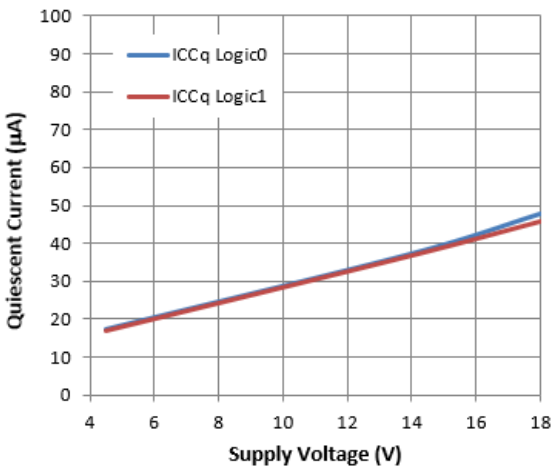
**Typical Performance Characteristics** (continued)



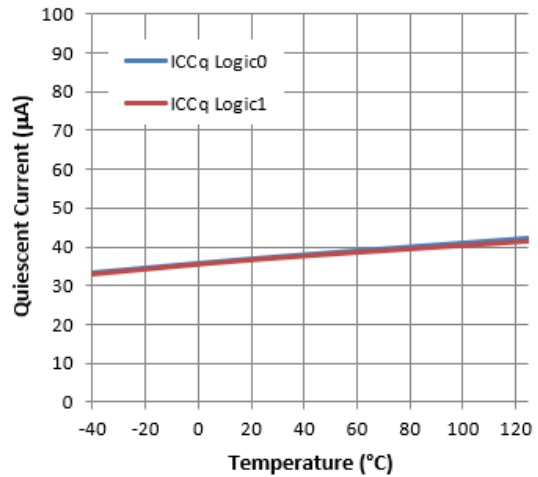
**Figure 10.** Fall Time vs. Supply Voltage



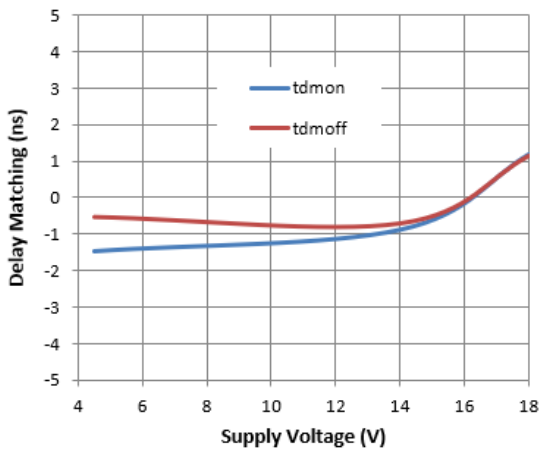
**Figure 11.** Fall Time vs. Temperature



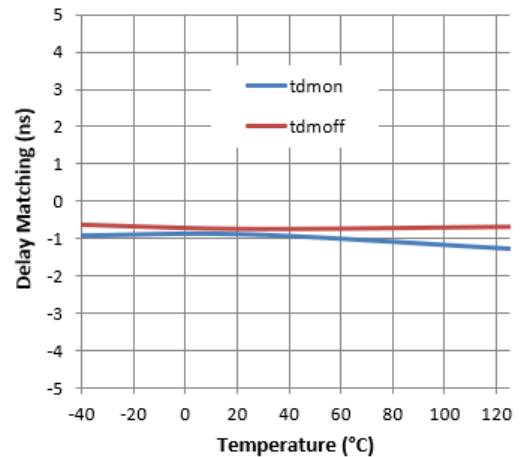
**Figure 12.** Quiescent Current vs. Supply Voltage



**Figure 13.** Quiescent Current vs. Temperature

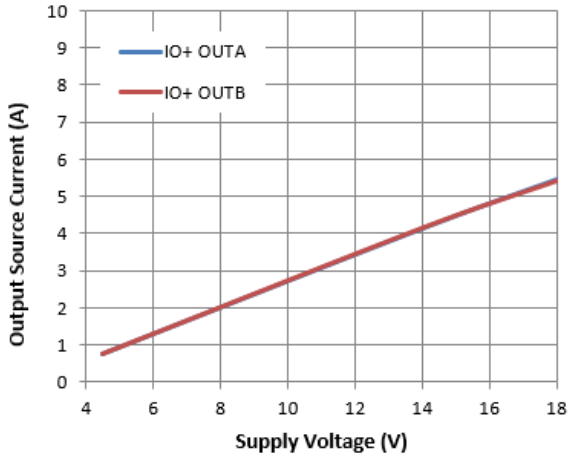


**Figure 14.** Delay Matching vs. Supply Voltage

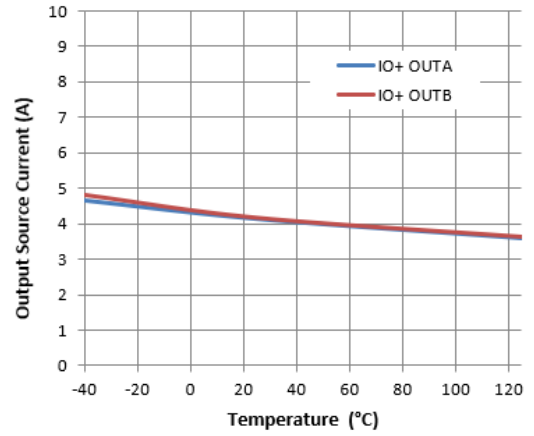


**Figure 15.** Delay Matching vs. Temperature

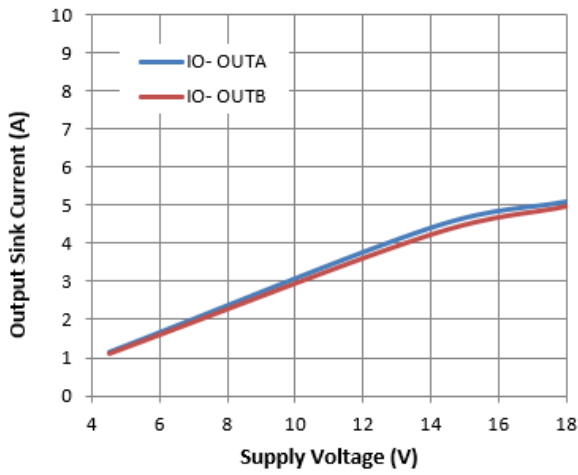
**Typical Performance Characteristics (cont.)**



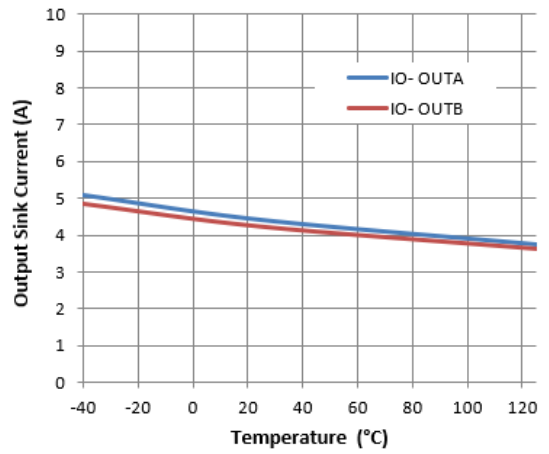
**Figure 16.** Output Source Current vs. Supply Voltage



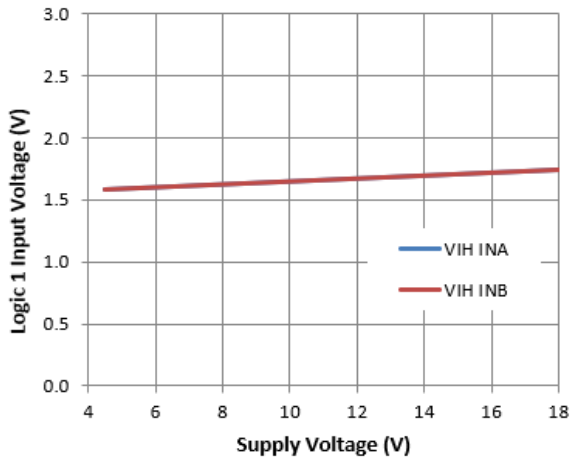
**Figure 17.** Output Source Current vs. Temperature



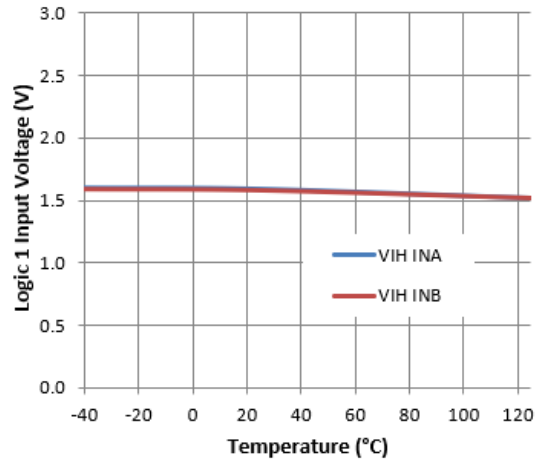
**Figure 18.** Output Sink Current vs. Supply Voltage



**Figure 19.** Output Sink Current vs. Temperature



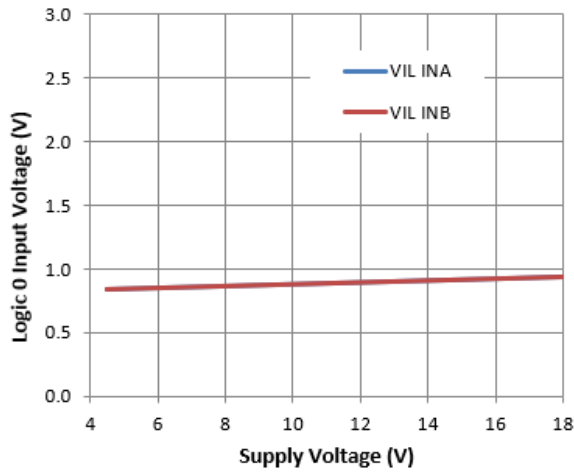
**Figure 20.** Logic 1 Input Voltage vs. Supply Voltage



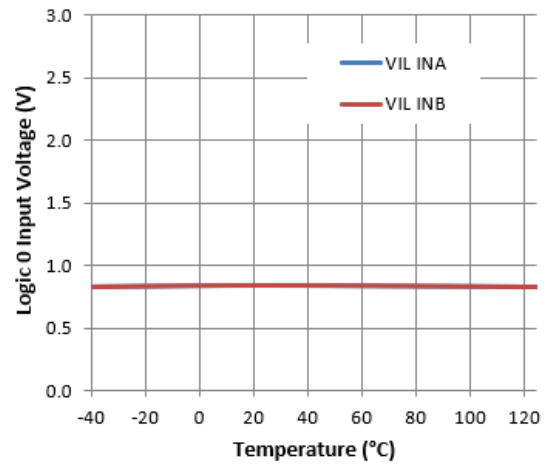
**Figure 21.** Logic 1 Input Voltage vs. Temperature



**Typical Performance Characteristics** (cont.)



**Figure 22.** Logic 0 Input Voltage vs. Supply Voltage

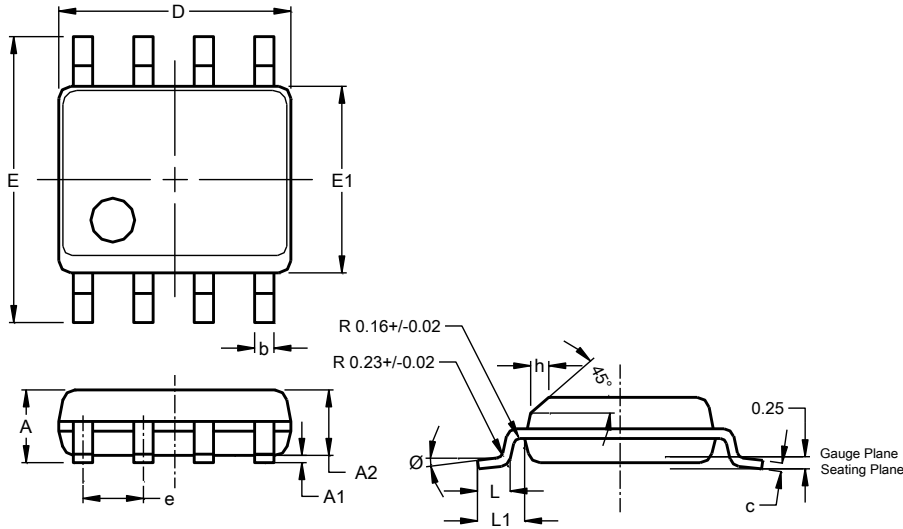


**Figure 23.** Logic 0 Input Voltage vs. Temperature

**Package Outline Dimensions**

Please see <http://www.diodes.com/package-outlines.html> for the latest version.

**SO-8 (Type TH)**

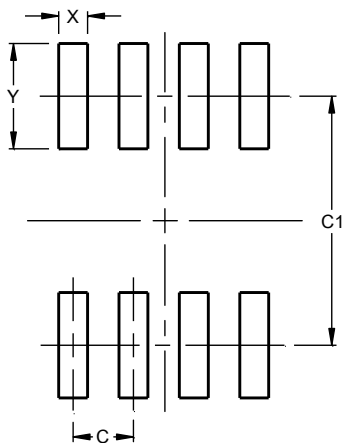


SO-8 (Type TH)			
Dim	Min	Max	Typ
A	1.35	1.75	—
A1	0.10	0.25	—
A2	—	—	1.45
b	0.35	0.51	—
c	0.190	0.248	—
D	4.80	5.00	4.90
E	5.80	6.20	6.00
E1	3.80	4.00	3.90
e	—	—	1.27
h	0.25	0.50	—
L	0.41	1.27	—
L1	—	—	1.04
Ø	0°	8°	—
All Dimensions in mm			

**Suggested Pad Layout**

Please see <http://www.diodes.com/package-outlines.html> for the latest version.

**SO-8 (Type TH)**



Dimensions	Value (in mm)
C	1.27
C1	5.20
X	0.60
Y	2.20

**IMPORTANT NOTICE**

DIODES INCORPORATED MAKES NO WARRANTY OF ANY KIND, EXPRESS OR IMPLIED, WITH REGARDS TO THIS DOCUMENT, INCLUDING, BUT NOT LIMITED TO, THE IMPLIED WARRANTIES OF MERCHANTABILITY AND FITNESS FOR A PARTICULAR PURPOSE (AND THEIR EQUIVALENTS UNDER THE LAWS OF ANY JURISDICTION).

Diodes Incorporated and its subsidiaries reserve the right to make modifications, enhancements, improvements, corrections or other changes without further notice to this document and any product described herein. Diodes Incorporated does not assume any liability arising out of the application or use of this document or any product described herein; neither does Diodes Incorporated convey any license under its patent or trademark rights, nor the rights of others. Any Customer or user of this document or products described herein in such applications shall assume all risks of such use and will agree to hold Diodes Incorporated and all the companies whose products are represented on Diodes Incorporated website, harmless against all damages.

Diodes Incorporated does not warrant or accept any liability whatsoever in respect of any products purchased through unauthorized sales channel. Should Customers purchase or use Diodes Incorporated products for any unintended or unauthorized application, Customers shall indemnify and hold Diodes Incorporated and its representatives harmless against all claims, damages, expenses, and attorney fees arising out of, directly or indirectly, any claim of personal injury or death associated with such unintended or unauthorized application.

Products described herein may be covered by one or more United States, international or foreign patents pending. Product names and markings noted herein may also be covered by one or more United States, international or foreign trademarks.

This document is written in English but may be translated into multiple languages for reference. Only the English version of this document is the final and determinative format released by Diodes Incorporated.

**LIFE SUPPORT**

Diodes Incorporated products are specifically not authorized for use as critical components in life support devices or systems without the express written approval of the Chief Executive Officer of Diodes Incorporated. As used herein:

A. Life support devices or systems are devices or systems which:

1. are intended to implant into the body, or
2. support or sustain life and whose failure to perform when properly used in accordance with instructions for use provided in the labeling can be reasonably expected to result in significant injury to the user.

B. A critical component is any component in a life support device or system whose failure to perform can be reasonably expected to cause the failure of the life support device or to affect its safety or effectiveness.

Customers represent that they have all necessary expertise in the safety and regulatory ramifications of their life support devices or systems, and acknowledge and agree that they are solely responsible for all legal, regulatory and safety-related requirements concerning their products and any use of Diodes Incorporated products in such safety-critical, life support devices or systems, notwithstanding any devices- or systems-related information or support that may be provided by Diodes Incorporated. Further, Customers must fully indemnify Diodes Incorporated and its representatives against any damages arising out of the use of Diodes Incorporated products in such safety-critical, life support devices or systems.

Copyright © 2018, Diodes Incorporated

[www.diodes.com](http://www.diodes.com)

## X-ON Electronics

Largest Supplier of Electrical and Electronic Components

*Click to view similar products for [Gate Drivers](#) category:*

*Click to view products by [Diodes Incorporated](#) manufacturer:*

Other Similar products are found below :

[00053P0231](#) [56956](#) [57.404.7355.5](#) [LT4936](#) [57.904.0755.0](#) [5882900001](#) [00600P0005](#) [00-9050-LRPP](#) [00-9090-RDPP](#) [5951900000](#) [01-1003W-10/32-15](#) [0131700000](#) [00-2240](#) [LTP70N06](#) [LVP640](#) [5J0-1000LG-SIL](#) [LY1D-2-5S-AC120](#) [LY2-US-AC240](#) [LY3-UA-DC24](#) [00576P0020](#) [00600P0010](#) [LZN4-UA-DC12](#) [LZNQ2M-US-DC5](#) [LZNQ2-US-DC12](#) [LZP40N10](#) [00-8196-RDPP](#) [00-8274-RDPP](#) [00-8275-RDNP](#) [00-8722-RDPP](#) [00-8728-WHPP](#) [00-8869-RDPP](#) [00-9051-RDPP](#) [00-9091-LRPP](#) [00-9291-RDPP](#) [0207100000](#) [0207400000](#) [01312](#) [0134220000](#) [60713816](#) [M15730061](#) [61161-90](#) [61278-0020](#) [6131-204-23149P](#) [6131-205-17149P](#) [6131-209-15149P](#) [6131-218-17149P](#) [6131-220-21149P](#) [6131-260-2358P](#) [6131-265-11149P](#) [CS1HCPU63](#)