

## Description

The DGD0590A is a high-frequency high-side and low-side gate driver capable of driving N-channel MOSFETs in a half-bridge configuration. The floating high-side driver is rated up to 40V and provides a 5V gate drive to the MOSFETs.

The DGD0590A logic inputs are compatible with standard TTL and CMOS levels (down to 3.3V) to interface easily with MCUs. A UVLO will protect ICs and MOSFETs with loss of supply.

Fast and well-matched propagation delays allow a higher switching frequency, enabling a smaller, more compact power switching design, using smaller associated components. The DGD0590A is offered in the V-QFN3030-8 package and operates over an extended -40°C to +125°C temperature range.

## Applications

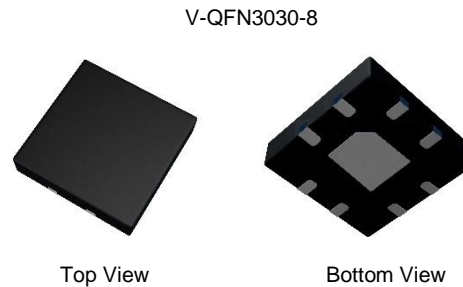
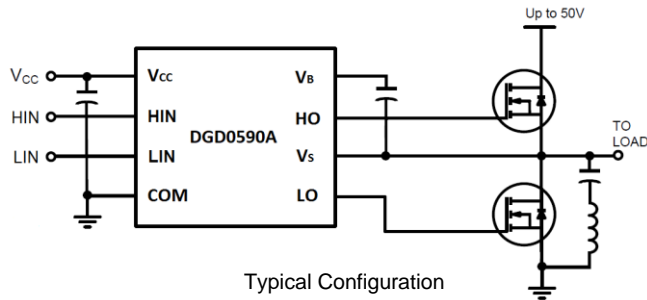
- Wireless Power Charger
- Motor Drive
- Logic Level MOSFET Gate Driver

## Features

- 40V Floating High-Side Driver
- Low  $V_{CC}$  Operating Voltage: 4.5V to 5.5V
- Drives Two N-channel Logic Level MOSFETs in a Half-Bridge Configuration
- High-Side 1.0A Source / 1.0A Sink and Low-Side 1.0A Source / 3.0A Sink Output Current Capability
- Internal Bootstrap Diode Included
- 3.4V UVLO with 0.4V Hysteresis
- Fast Rise and Fall Times (27ns/17ns) with 3nF Load
- Propagation Delay Typical of 16ns for High-Side and 12ns for Low-Side
- Extended Temperature Range: -40°C to +125°C
- **Totally Lead-Free & Fully RoHS Compliant (Notes 1 & 2)**
- **Halogen and Antimony Free. "Green" Device (Note 3)**

## Mechanical Data

- Case: V-QFN3030-8 (Type TH)
- Case Material: Molded Plastic. "Green" Molding Compound. UL Flammability Classification Rating 94V-0
- Moisture Sensitivity: Level 3 per J-STD-020
- Terminals: Finish – Matte Tin Finish. Solderable per MIL-STD-202, Method 208
- Weight: 0.017 grams (Approximate)



## Ordering Information (Note 4)

Part Number	Marking	Reel Size (inches)	Tape Width (mm)	Quantity per Reel
DGD0590AFU-7	DGD0590A	7	8	3,000

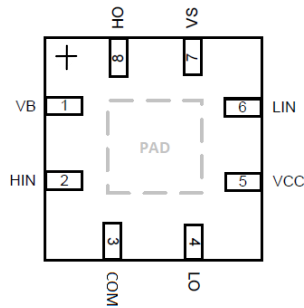
- Notes:
1. No purposely added lead. Fully EU Directive 2002/95/EC (RoHS), 2011/65/EU (RoHS 2) & 2015/863/EU (RoHS 3) compliant.
  2. See <https://www.diodes.com/quality/lead-free/> for more information about Diodes Incorporated's definitions of Halogen- and Antimony-free, "Green" and Lead-free.
  3. Halogen- and Antimony-free "Green" products are defined as those which contain <900ppm bromine, <900ppm chlorine (<1500ppm total Br + Cl) and <1000ppm antimony compounds.
  4. For packaging details, go to our website at <https://www.diodes.com/design/support/packaging/diodes-packaging/>.

## Marking Information



DGD0590A = Product Type Marking Code  
 YY = Year (ex: 19 = 2019)  
 WW = Week (01 to 53)

## Pin Diagrams

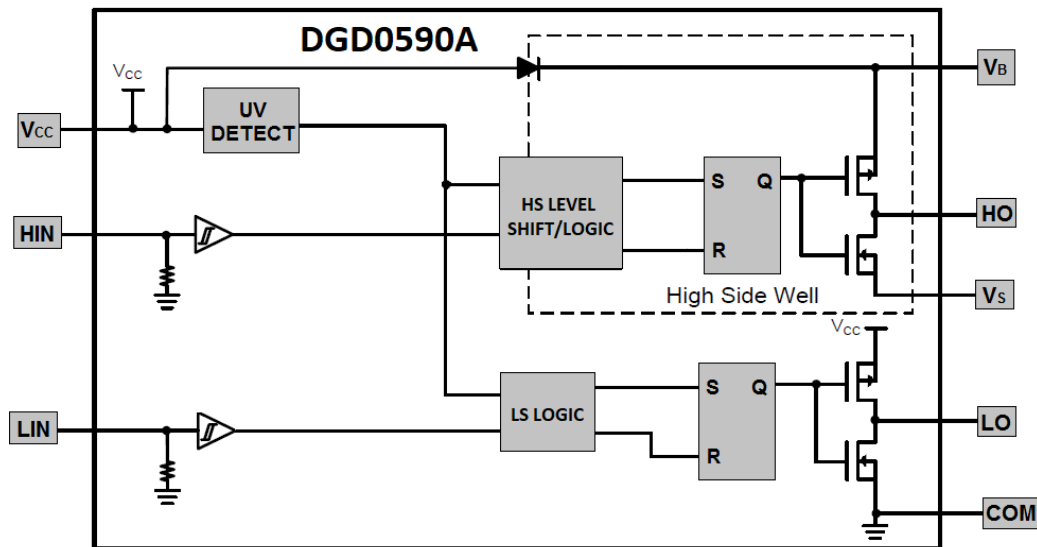


Top View: V-QFN3030-8

## Pin Descriptions

Pin Number	Pin Name	Function
1	VB	High-Side Floating Supply
2	HIN	Logic Input for High-Side Gate Driver, in Phase with HO, Pull Down Resistor at Input
3	COM	Low-Side and Logic Return
4	LO	Low-Side Gate Driver Output
5	VCC	Low-Side and Logic Supply
6	LIN	Logic Input for Low-Side Gate Driver, in Phase with LO, Pull Down Resistor at Input
7	VS	High-Side Floating Supply Return
8	HO	High-Side Gate Driver Output
PAD	Substrate	Connect to COM on PCB

## Functional Block Diagram



**Absolute Maximum Ratings** (@ $T_A = +25^\circ\text{C}$ , unless otherwise specified.)

Characteristic	Symbol	Value	Unit
High-Side Floating Positive Supply Voltage	$V_B$	0.3 to +50	V
High-Side Floating Negative Supply Voltage	$V_S$	$V_B - 6$ to $V_B + 0.3$	V
High-Side Floating Output Voltage	$V_{HO}$	$V_S - 0.3$ to $V_B + 0.3$	V
Offset Supply Voltage Transient	$dV_S / dt$	50	V/ns
Logic and Low-Side Fixed Supply Voltage	$V_{CC}$	-0.3 to +6	V
Low-Side Output Voltage	$V_{LO}$	-0.3 to $V_{CC} + 0.3$	V
Logic Input Voltage (HIN and LIN)	$V_{IN}$	-0.3 to +6	V

**Thermal Characteristics** (@ $T_A = +25^\circ\text{C}$ , unless otherwise specified.)

Characteristic	Symbol	Value	Unit
Thermal Resistance, Junction to Ambient (Note 5)	$R_{\theta JA}$	120	$^\circ\text{C}/\text{W}$
Thermal Resistance, Junction to Case (Note 5)	$R_{\theta JC}$	132	$^\circ\text{C}/\text{W}$
Operating Temperature	$T_J$	+150	$^\circ\text{C}$
Lead Temperature (Soldering, 10s)	$T_L$	+300	
Storage Temperature Range	$T_{STG}$	-55 to +150	

Note: 5. When mounted on a standard JEDEC 2-layer FR-4 board.

**Recommended Operating Conditions**

Parameter	Symbol	Min	Max	Unit
High-Side Floating Supply	$V_B$	$V_S + 4.5$	$V_S + 5.5$	V
High-Side Floating Supply Offset Voltage	$V_S$	0	40 (Note 6)	V
High-Side Floating Output Voltage	$V_{HO}$	$V_S$	$V_B$	V
Logic and Low Side Fixed Supply Voltage	$V_{CC}$	4.5	5.5	V
Low-Side Output Voltage	$V_{LO}$	0	$V_{CC}$	V
Logic Input Voltage (HIN and LIN)	$V_{IN}$	0	5	V
Ambient Temperature	$T_A$	-40	+125	$^\circ\text{C}$

Note: 6. Provided  $V_B$  doesn't exceed absolute maximum rating of 50V.

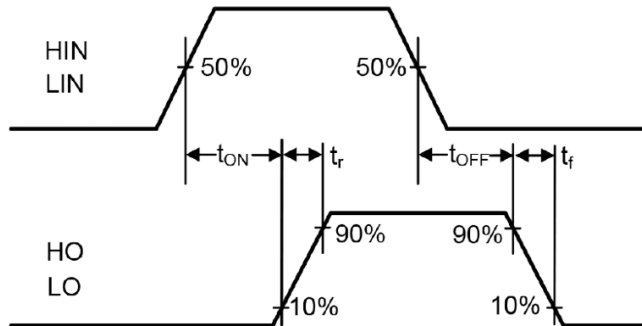
**DC Electrical Characteristics** ( $V_{CC} = 5V$ ,  $@T_A = +25^\circ C$ , unless otherwise specified.)

Parameter	Symbol	Min	Typ	Max	Unit	Conditions
Logic "1" Input Voltage, HIN	$V_{HIH}$	—	3.5	3.8	V	—
Logic "0" Input Voltage, HIN	$V_{HIL}$	1.0	1.3	—	V	—
Logic "1" Input Voltage, LIN	$V_{LIH}$	—	2.8	3.3	V	—
Logic "0" Input Voltage, LIN	$V_{LIL}$	1.0	1.2	—	V	—
Logic Input Bias Current	$I_{IN+}$	—	31	60	$\mu A$	$V_{IN} = V_{CC}$
$V_{CC}$ Quiescent Supply Current	$I_{CCQ}$	—	22	50	$\mu A$	—
$V_{CC}$ Operating Supply Current	$I_{CCO}$	—	300	—	$\mu A$	HO and LO Open, $f_s = 250kHz$
High-Side Source Impedance	$R_{HSO}$	—	1.8	2.6	$\Omega$	$I_{SOURCE} = 100mA$
High-Side Sink Impedance	$R_{HSI}$	—	1.5	2.1	$\Omega$	$I_{SINK} = 100mA$
Low-Side Source Impedance	$R_{LSO}$	—	1.8	2.6	$\Omega$	$I_{SOURCE} = 100mA$
Low-Side Sink Impedance	$R_{LSI}$	—	0.4	1.0	$\Omega$	$I_{SINK} = 100mA$
$V_{CC}$ Supply Undervoltage Positive Going Threshold	$V_{CCUV+}$	2.85	3.4	3.85	V	—
$V_{CC}$ Supply Undervoltage Hysteresis	$V_{CCU\_HYST}$	—	0.4	—	V	—
Bootstrap Diode Forward Voltage	$V_{BFD}$	—	650	800	mV	$I = 100\mu A$
Bootstrap Diode Reverse Leakage	$I_{BDL}$	—	0.1	0.4	$\mu A$	$V_B = V_S = 45.5V$ , $V_{CC} = 0V$

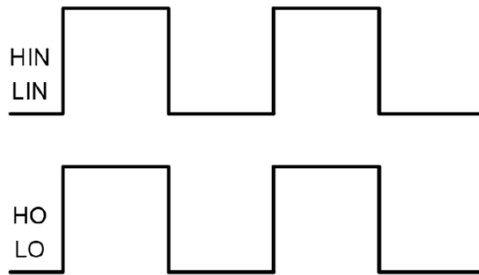
**AC Electrical Characteristics** ( $V_{CC} = 5V$ ,  $C_L = 3nF$ ,  $@T_A = +25^\circ C$ , unless otherwise specified.)

Parameter	Symbol	Min	Typ	Max	Unit	Conditions
Turn-On Rise Time	$t_R$	—	27	—	ns	—
Turn-Off Fall Time, High-Side	$t_F$	—	29	—	ns	—
Turn-Off Fall Time, Low-Side		—	17	—	ns	—
Turn-On Propagation Delay Time, High-Side	$t_{ONH}$	—	16	—	ns	—
Turn-Off Propagation Delay Time, High-Side	$t_{OFFH}$	—	17	—	ns	—
Turn-On Propagation Delay Time, Low-Side	$t_{ONL}$	—	12	—	ns	—
Turn-Off Propagation Delay Time, Low-Side	$t_{OFFL}$	—	17	—	ns	—

**Timing Waveforms**

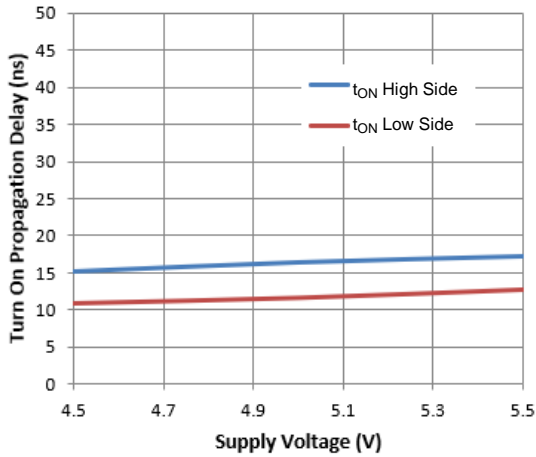


**Figure 1.** Switching Time Waveform Definitions

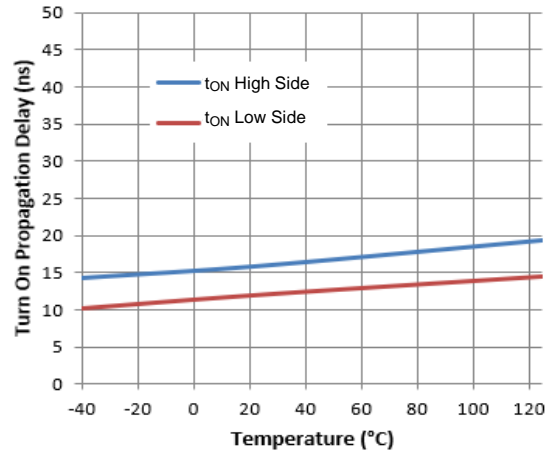


**Figure 2.** Input / Output Timing Diagram

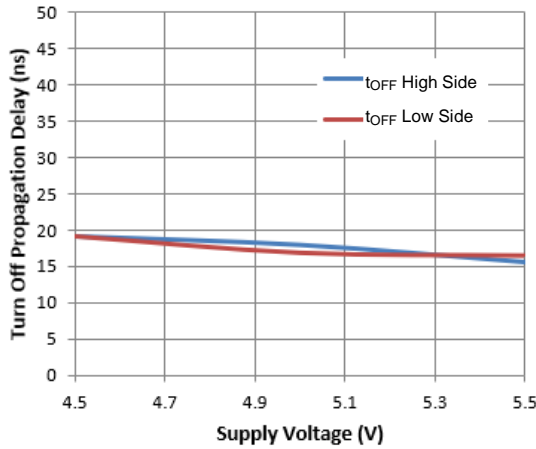
**Typical Performance Characteristics** (@T<sub>A</sub> = +25°C, unless otherwise specified.)



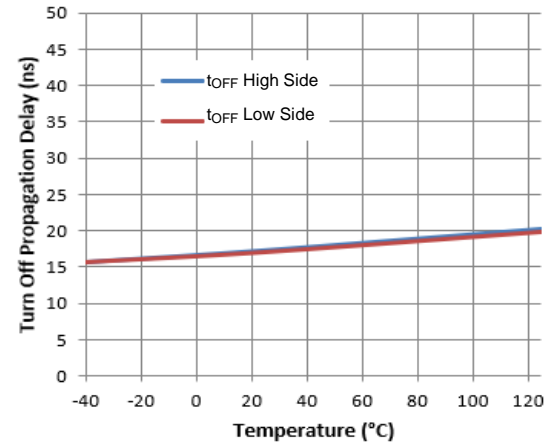
**Figure 3.** Turn-on Propagation Delay vs. Supply Voltage



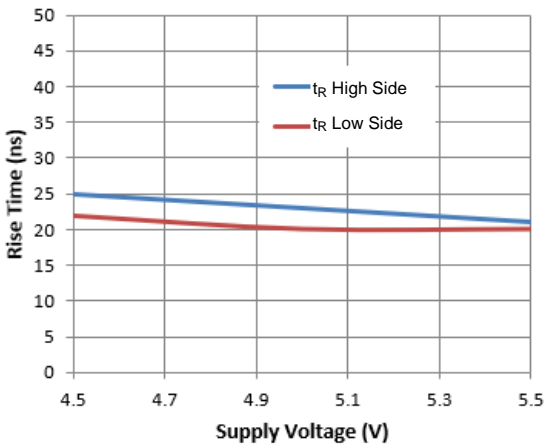
**Figure 4.** Turn-on Propagation Delay vs. Temperature



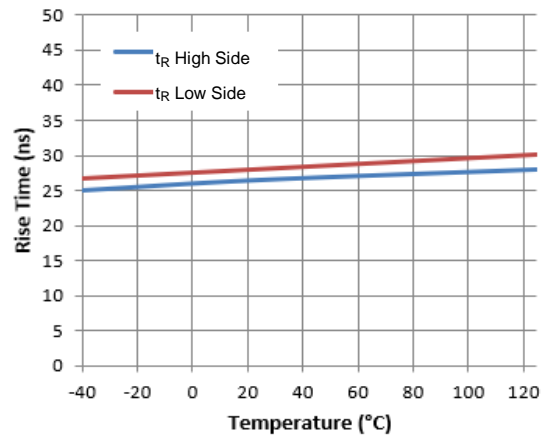
**Figure 5.** Turn-off Propagation Delay vs. Supply Voltage



**Figure 6.** Turn-off Propagation Delay vs. Temperature

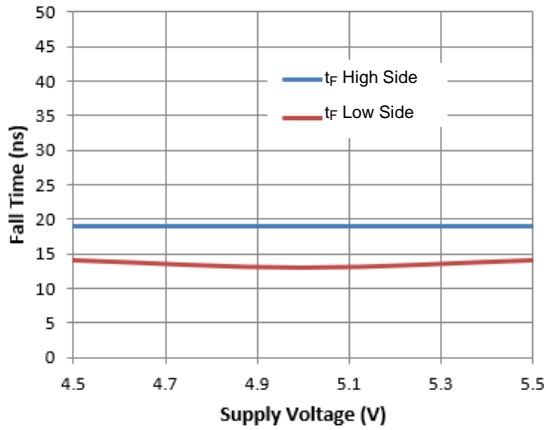


**Figure 7.** Rise Time vs. Supply Voltage

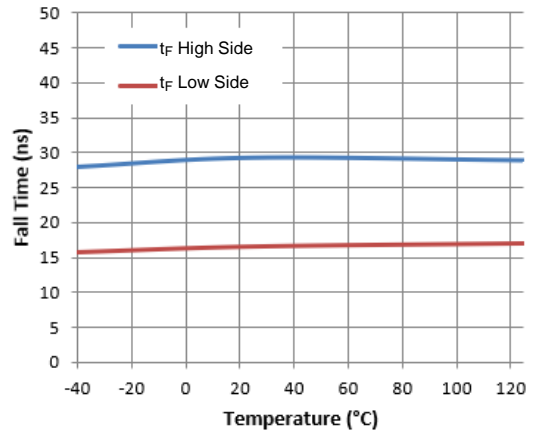


**Figure 8.** Rise Time vs. Temperature

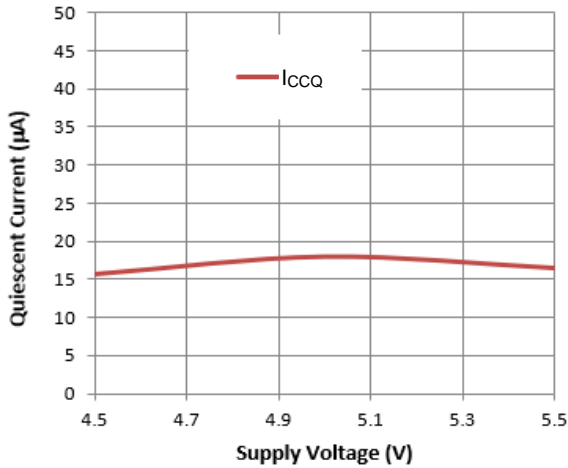
**Typical Performance Characteristics** (continued)



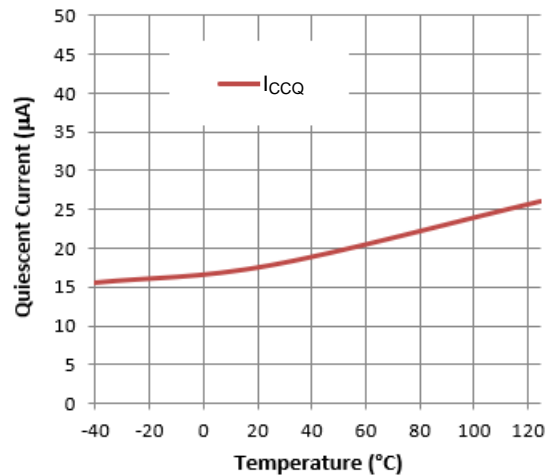
**Figure 9.** Fall Time vs. Supply Voltage



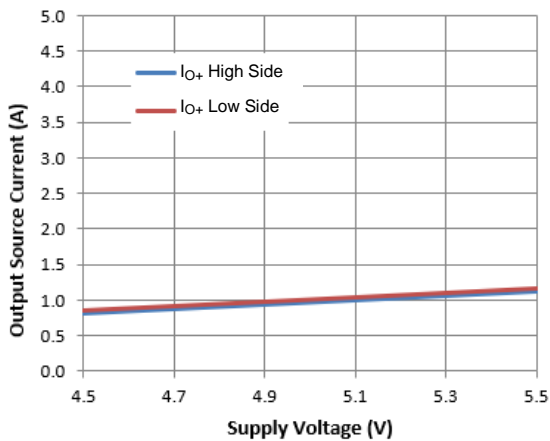
**Figure 10.** Fall Time vs. Temperature



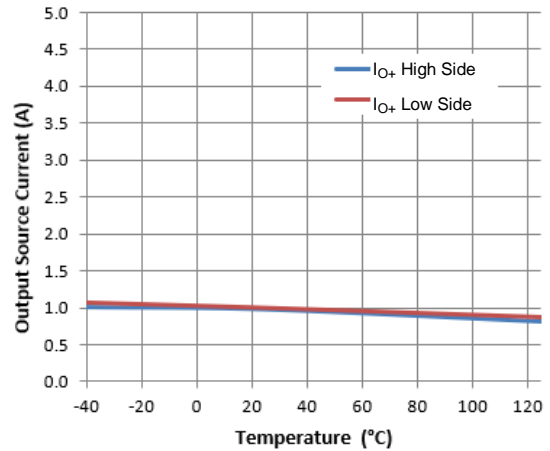
**Figure 11.** Quiescent Current vs. Supply Voltage



**Figure 12.** Quiescent Current vs. Temperature

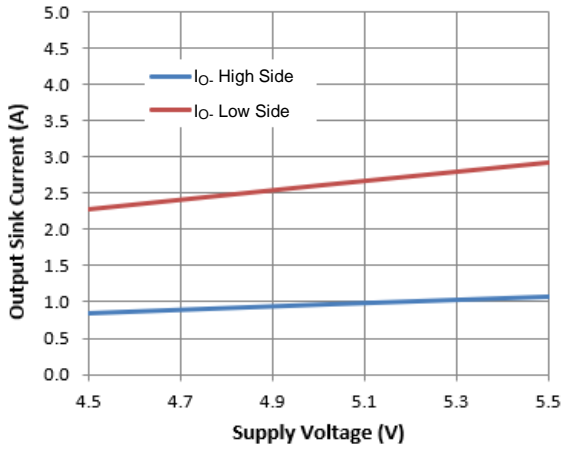


**Figure 13.** Output Source Current vs. Supply Voltage

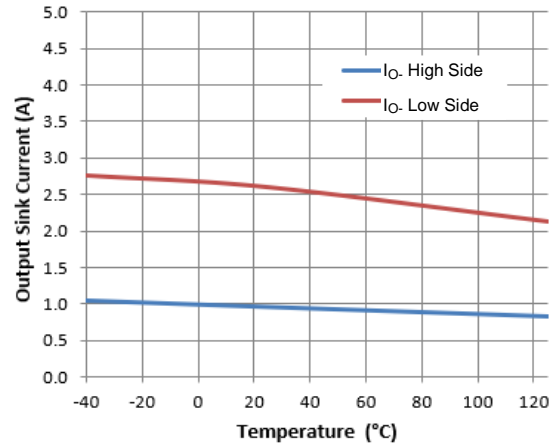


**Figure 14.** Output Source Current vs. Temperature

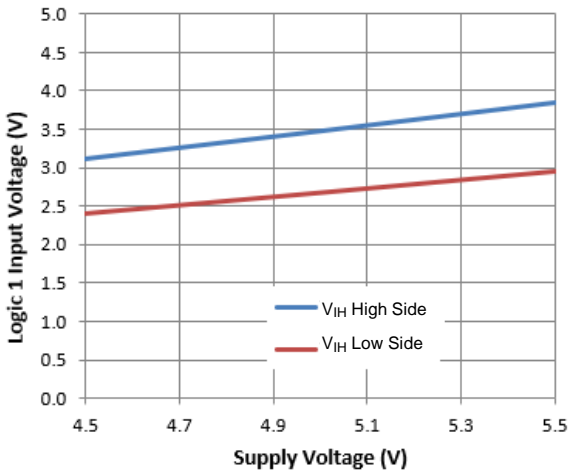
**Typical Performance Characteristics** (continued)



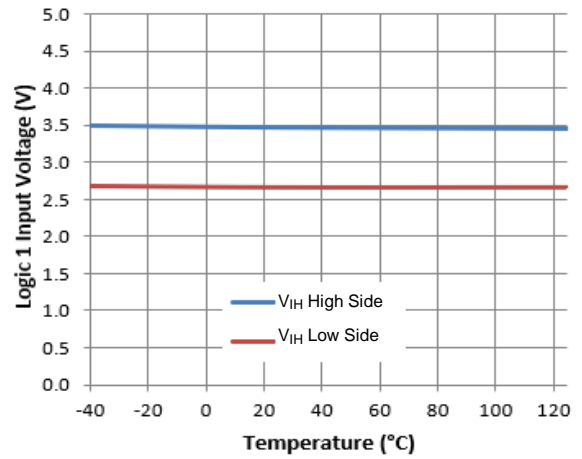
**Figure 15.** Output Sink Current vs. Supply Voltage



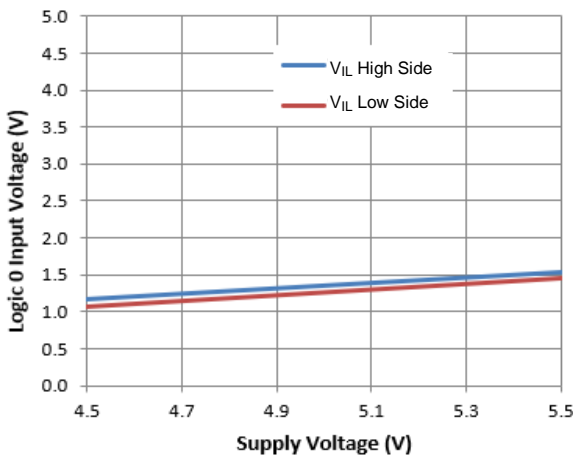
**Figure 16.** Output Sink Current vs. Temperature



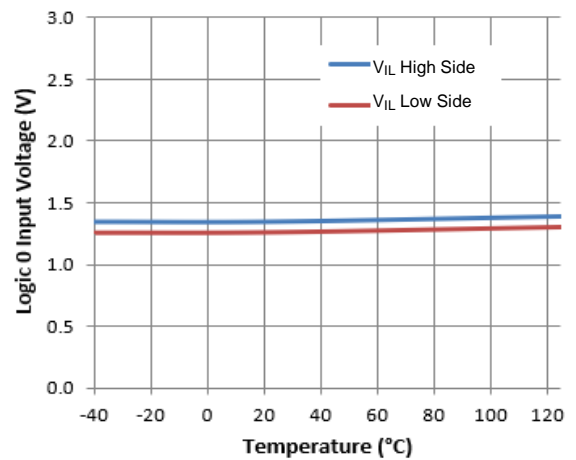
**Figure 17.** Logic 1 Input Voltage vs. Supply Voltage



**Figure 18.** Logic 1 Input Voltage vs. Temperature



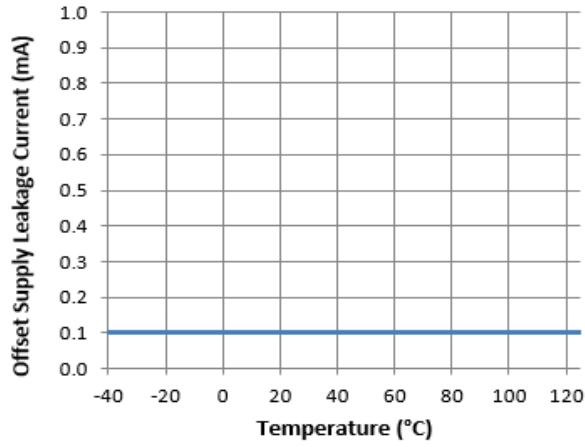
**Figure 19.** Logic 0 Input Voltage vs. Supply Voltage



**Figure 20.** Logic 0 Input Voltage vs. Temperature



**Typical Performance Characteristics** (continued)

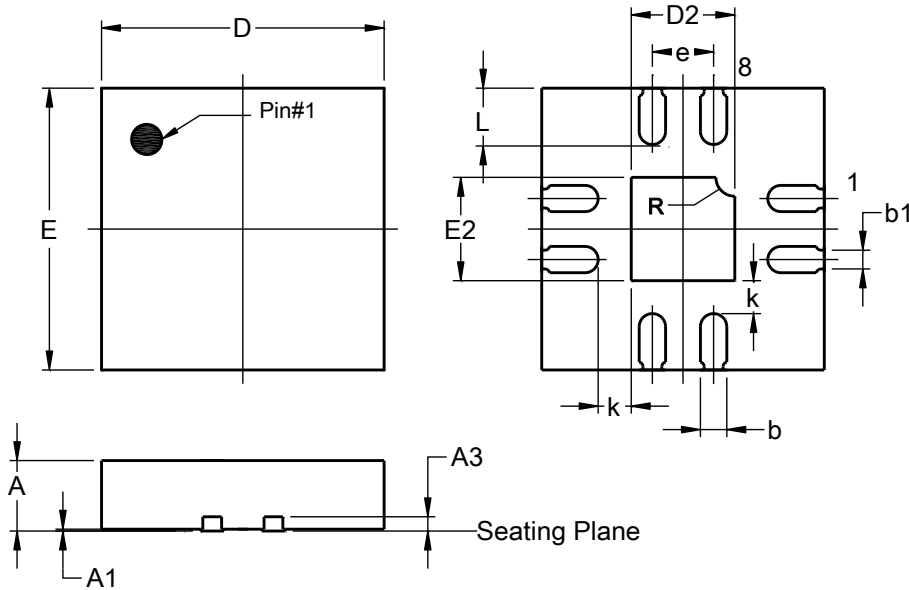


**Figure 21.** Offset Supply Leakage Current vs. Temperature

**Package Outline Dimensions**

Please see <http://www.diodes.com/package-outlines.html> for the latest version.

V-QFN3030-8 (Type TH)

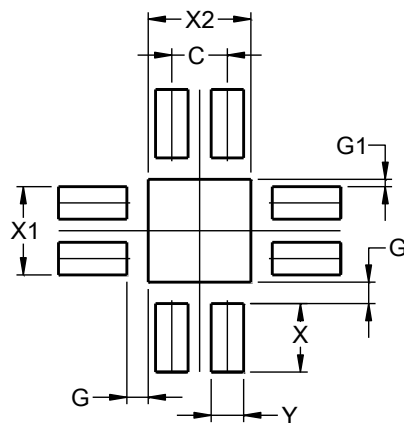


V-QFN3030-8 (Type TH)			
Dim	Min	Max	Typ
A	0.70	0.80	0.75
A1	0.00	0.05	0.02
A3	0.203REF		
b	0.23	0.33	0.28
b1	0.20REF		
D	2.90	3.10	3.00
D2	1.00	1.20	1.10
E	2.90	3.10	3.00
E2	1.00	1.20	1.10
e	0.65BSC		
L	0.55	0.65	0.60
k	0.30	0.40	0.35
R	0.20REF		
All Dimensions in mm			

**Suggested Pad Layout**

Please see <http://www.diodes.com/package-outlines.html> for the latest version.

V-QFN3030-8 (Type TH)



Dimensions	Value (in mm)
C	0.650
G	0.250
G1	0.085
X	0.800
X1	1.030
X2	1.200
Y	0.380

**IMPORTANT NOTICE**

DIODES INCORPORATED MAKES NO WARRANTY OF ANY KIND, EXPRESS OR IMPLIED, WITH REGARDS TO THIS DOCUMENT, INCLUDING, BUT NOT LIMITED TO, THE IMPLIED WARRANTIES OF MERCHANTABILITY AND FITNESS FOR A PARTICULAR PURPOSE (AND THEIR EQUIVALENTS UNDER THE LAWS OF ANY JURISDICTION).

Diodes Incorporated and its subsidiaries reserve the right to make modifications, enhancements, improvements, corrections or other changes without further notice to this document and any product described herein. Diodes Incorporated does not assume any liability arising out of the application or use of this document or any product described herein; neither does Diodes Incorporated convey any license under its patent or trademark rights, nor the rights of others. Any Customer or user of this document or products described herein in such applications shall assume all risks of such use and will agree to hold Diodes Incorporated and all the companies whose products are represented on Diodes Incorporated website, harmless against all damages.

Diodes Incorporated does not warrant or accept any liability whatsoever in respect of any products purchased through unauthorized sales channel. Should Customers purchase or use Diodes Incorporated products for any unintended or unauthorized application, Customers shall indemnify and hold Diodes Incorporated and its representatives harmless against all claims, damages, expenses, and attorney fees arising out of, directly or indirectly, any claim of personal injury or death associated with such unintended or unauthorized application.

Products described herein may be covered by one or more United States, international or foreign patents pending. Product names and markings noted herein may also be covered by one or more United States, international or foreign trademarks.

This document is written in English but may be translated into multiple languages for reference. Only the English version of this document is the final and determinative format released by Diodes Incorporated.

**LIFE SUPPORT**

Diodes Incorporated products are specifically not authorized for use as critical components in life support devices or systems without the express written approval of the Chief Executive Officer of Diodes Incorporated. As used herein:

A. Life support devices or systems are devices or systems which:

1. are intended to implant into the body, or
2. support or sustain life and whose failure to perform when properly used in accordance with instructions for use provided in the labeling can be reasonably expected to result in significant injury to the user.

B. A critical component is any component in a life support device or system whose failure to perform can be reasonably expected to cause the failure of the life support device or to affect its safety or effectiveness.

Customers represent that they have all necessary expertise in the safety and regulatory ramifications of their life support devices or systems, and acknowledge and agree that they are solely responsible for all legal, regulatory and safety-related requirements concerning their products and any use of Diodes Incorporated products in such safety-critical, life support devices or systems, notwithstanding any devices- or systems-related information or support that may be provided by Diodes Incorporated. Further, Customers must fully indemnify Diodes Incorporated and its representatives against any damages arising out of the use of Diodes Incorporated products in such safety-critical, life support devices or systems.

Copyright © 2019, Diodes Incorporated

[www.diodes.com](http://www.diodes.com)

## X-ON Electronics

Largest Supplier of Electrical and Electronic Components

*Click to view similar products for [Gate Drivers](#) category:*

*Click to view products by [Diodes Incorporated](#) manufacturer:*

Other Similar products are found below :

[00053P0231](#) [56956](#) [57.404.7355.5](#) [LT4936](#) [57.904.0755.0](#) [5882900001](#) [00600P0005](#) [00-9050-LRPP](#) [00-9090-RDPP](#) [5951900000](#) [01-1003W-10/32-15](#) [0131700000](#) [00-2240](#) [LTP70N06](#) [LVP640](#) [5J0-1000LG-SIL](#) [LY1D-2-5S-AC120](#) [LY2-US-AC240](#) [LY3-UA-DC24](#) [00576P0020](#) [00600P0010](#) [LZN4-UA-DC12](#) [LZNQ2M-US-DC5](#) [LZNQ2-US-DC12](#) [LZP40N10](#) [00-8196-RDPP](#) [00-8274-RDPP](#) [00-8275-RDNP](#) [00-8722-RDPP](#) [00-8728-WHPP](#) [00-8869-RDPP](#) [00-9051-RDPP](#) [00-9091-LRPP](#) [00-9291-RDPP](#) [0207100000](#) [0207400000](#) [01312](#) [0134220000](#) [60713816](#) [M15730061](#) [61161-90](#) [61278-0020](#) [6131-204-23149P](#) [6131-205-17149P](#) [6131-209-15149P](#) [6131-218-17149P](#) [6131-220-21149P](#) [6131-260-2358P](#) [6131-265-11149P](#) [CS1HCPU63](#)