

Description

The DML3006LFDS load switch provides a component and area-reducing solution for efficient power domain switching with inrush current limit via soft-start. In addition to integrated control functionality with ultra low on-resistance, this device offers system safeguards and monitoring via fault protection and power good signaling. This cost effective solution is ideal for power management and hot-swap applications requiring low power consumption in a small footprint.

Applications

- Portable Electronics and Systems
- Notebook and Tablet Computers
- Telecom, Networking, Medical, and Industrial Equipment
- Set-Top Boxes, Servers, and Gateways
- Hot-Swap Devices and Peripheral Ports

Features and Benefits

- Advanced Controller with ChargePump
- Integrated N-Channel MOSFET with Ultra Low R_{ON}
- Input Voltage Range 0.5V to 13.5V
- Soft-Start via Controlled SlewRate
- Power Good Signal
- Thermal Shutdown
- V_{IN} Under-Voltage Lockout
- Short-Circuit Protection
- Extremely Low Standby Current
- Load Bleed (Quick Discharge)
- **Totally Lead-Free & Fully RoHS Compliant (Notes 1 & 2)**
- **Halogen and Antimony Free. "Green" Device (Note 3)**



Top View

V-DFN2020-8 (Type F)

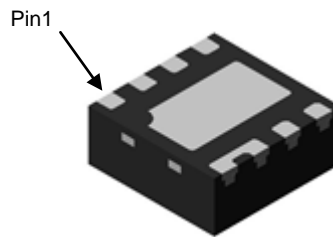

Bottom View

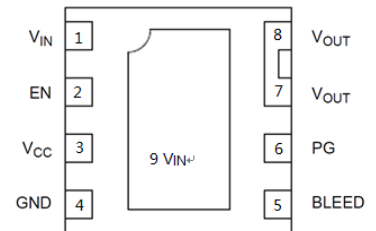

Top View

Ordering Information (Note 4)

Part Number	Case	Packaging
DML3006LFDS-7	V-DFN2020-8 (Type F)	3,000/Tape & Reel

- Notes:
1. No purposely added lead. Fully EU Directive 2002/95/EC (RoHS), 2011/65/EU (RoHS 2) & 2015/863/EU (RoHS 3) compliant.
 2. See <https://www.diodes.com/quality/lead-free/> for more information about Diodes Incorporated's definitions of Halogen- and Antimony-free, "Green" and Lead-free.
 3. Halogen- and Antimony-free "Green" products are defined as those which contain <900ppm bromine, <900ppm chlorine (<1500ppm total Br + Cl) and <1000ppm antimony compounds.
 4. For packaging details, go to our website at <https://www.diodes.com/design/support/packaging/diodes-packaging/>.

Marking Information

V-DFN2020-8 (Type F)

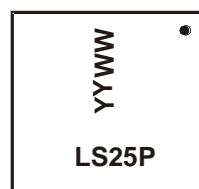

LS25P = Product Type Marking Code
 YYWW = Date Code Marking
 YY = Last Two Digits of Year (ex: 19 = 2019)
 WW = Week Code (01 to 53)

Typical Applications Circuit

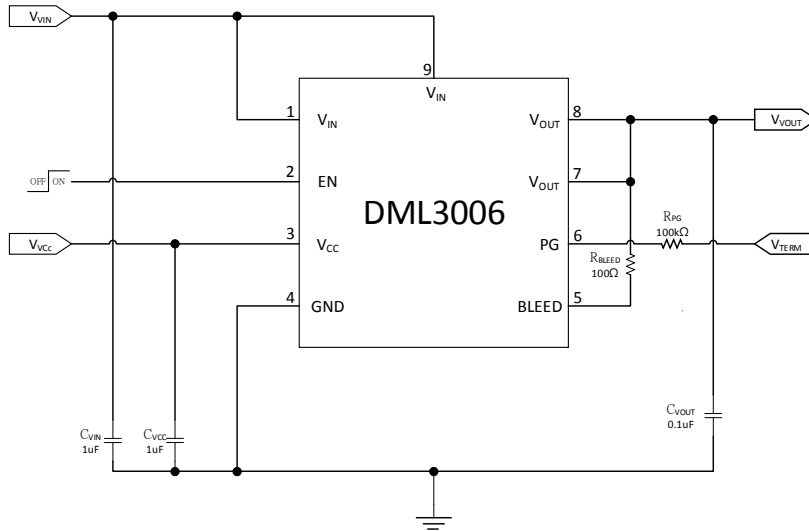

Pin Description

Pin Number	Pin Name	Pin Function
1, 9	V _{IN}	Drain of MOSFET (0.5V to 13.5V), Pin 1 must be connected to Pin 9
2	EN	Active-high digital input used to turn on the MOSFET, pin has an internal pull down resistor to GND
3	V _{CC}	Supply voltage to controller (3.0V to 5.5V)
4	GND	Controller ground
5	BLEED	Load bleed connection, must be tied to V _{OUT} through a resistor ≤ 1kΩ
6	PG	Active-high, open-drain output that indicates when the gate of the MOSFET is fully charged, external pull up resistor ≥ 1kΩ to an external voltage source required; tie to GND if not used.
7, 8	V _{OUT}	Source of MOSFET connected to load

Function Block Diagram

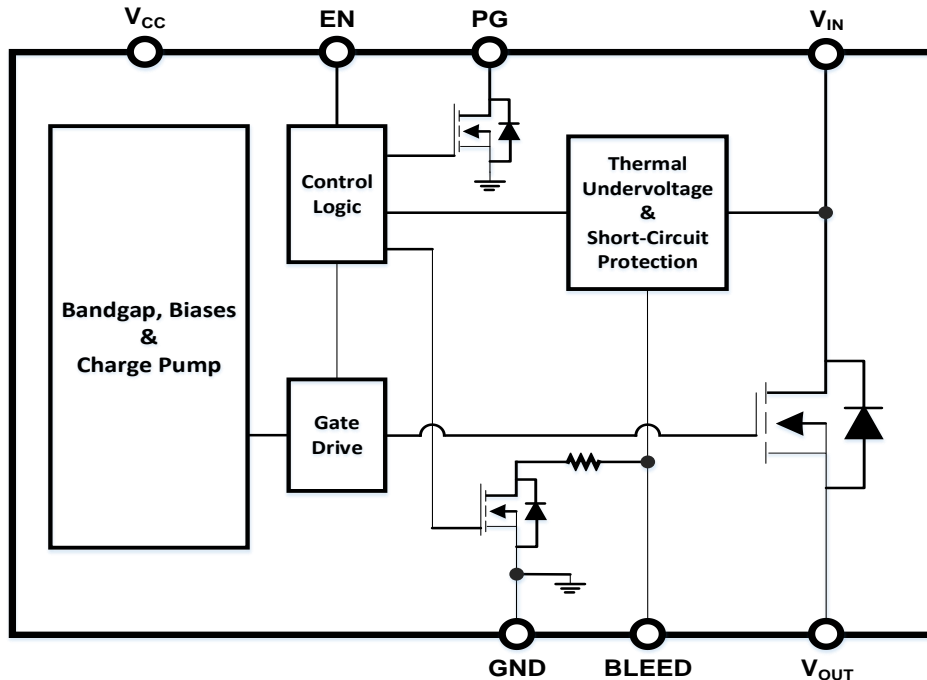

Absolute Maximum Ratings

Parameter	Rating
V _{IN} , BLEED, V _{OUT} to GND	-0.3V to 18V
EN, V _{CC} , PG to GND	-0.3V to 6V
I _{MAX}	10.5A
Junction Temperature (T _J)	+150°C
Storage Temperature (T _S)	-65°C to +150°C

Recommended Operating Ranges

Parameter	Rating
Supply Voltage (V _{CC})	3V to 5.5V
Input Voltage (V _{IN})	0.5V to 13.5V
Ambient Temperature (T _A)	-40°C to +85°C
Package Thermal Resistance (θ _{JC})	5.3°C/W
Package Thermal Resistance (θ _{JA})	40°C/W

Electrical Characteristics (T_A = +25°C, V_{CC}=3.3V, V_{IN}=5V=V_{TERM}, C_{VIN}=1μF, C_{VOUT}=0.1μF, C_{VCC}=1μF, C_{SR}=1nF, unless otherwise specified.)

Symbol	Parameter	Conditions	Min	Typ	Max	Unit
V _{IN}	Input Voltage	—	0.5	—	13.5	V
V _{CC}	Supply Voltage	—	3.0	—	5.5	V
I _{DYN}	V _{CC} Dynamic Supply Current	V _{EN} = V _{CC} = 3V, V _{IN} = 12V	—	310	400	μA
		V _{EN} = V _{CC} = 5.5V, V _{IN} = 1.8V	—	510	750	μA
I _{STBY}	V _{CC} Shutdown Supply Current	V _{CC} = 3V, V _{EN} = 0V	—	0.1	1	μA
		V _{CC} = 5.5V, V _{EN} = 0V	—	0.1	2	μA
V _{ENH}	EN High Level Voltage	V _{CC} = 3V to 5.5V	2.0	—	—	V
V _{ENL}	EN Low Level Voltage	V _{CC} = 3V to 5.5V	—	—	0.8	V
R _{BLEED}	Bleed Resistance	V _{CC} = 3V, V _{EN} = 0V	86	108	130	Ω
		V _{CC} = 5.5V, V _{EN} = 0V	64	80	100	Ω
I _{BLEED}	Bleed Pin Leakage Current	V _{CC} = V _{EN} = 3V, V _{IN} = 1.8V	—	20	45	μA
		V _{CC} = V _{EN} = 3V, V _{IN} = 12V	—	50	70	μA
V _{PGL}	PG Output Low Voltage	V _{CC} = 3V; I _{SINK} = 5mA	—	—	0.2	V
I _{PG}	PG Output Leakage Current	V _{CC} = 3V; V _{TERM} = 3.3V	—	—	100	nA
Switching Device						
R _{ON}	Switch On-State Resistance	V _{CC} = 3.3V, V _{IN} = 1.8V	—	10.8	12.5	mΩ
		V _{CC} = 3.3V, V _{IN} = 5V	—	10.8	12.5	mΩ
		V _{CC} = 3.3V, V _{IN} = 12V	—	10.8	12.5	mΩ
		V _{CC} = 5V, V _{IN} = 1.8V	—	8.6	10.5	mΩ
		V _{CC} = 5V, V _{IN} = 5V	—	8.6	10.5	mΩ
		V _{CC} = 5V, V _{IN} = 12V	—	8.6	10.5	mΩ
I _{LEAK}	Input Shutdown Supply Current	V _{EN} = 0V, V _{IN} = 13.5V	—	—	1	μA
R _{PDEN}	EN Pull Down Resistance	—	76	100	124	kΩ
Fault Protection						
OTP	Thermal Shutdown Threshold	V _{CC} = 3V to 5.5V	—	145	—	°C
OTPHYS	Thermal Shutdown Hysteresis	V _{CC} = 3V to 5.5V	—	20	—	°C
UVLO	V _{IN} Lockout Threshold	V _{CC} = 3V	0.25	0.35	0.45	V
UVLOHYS	V _{IN} Lockout Hysteresis	V _{CC} = 3V	20	40	70	mV
SCP	Short-Circuit Protection Threshold	V _{CC} = 3.3V; V _{IN} = 0.5V	180	265	350	mV
		V _{CC} = 3.3V; V _{IN} = 13.5V	100	285	500	mV

Switching Characteristics ($T_A = +25^\circ\text{C}$, $V_{\text{TERM}}=V_{\text{VCC}}=5\text{V}$, $R_{\text{PG}}=100\text{k}\Omega$, $R_{\text{VOUT}}=10\Omega$, $C_{\text{VIN}}=1\mu\text{F}$, $C_{\text{VOUT}}=0.1\mu\text{F}$, $C_{\text{VCC}}=1\mu\text{F}$, unless otherwise specified.)

NEW PRODUCT

Symbol	Parameter	Condition	Min	Typ	Max	Unit
$V_{\text{IN}} = 1.8\text{V}$						
t_{ON}	Output Turn-On Delay time	$V_{\text{CC}}=3.3\text{V}$	—	200	—	μs
		$V_{\text{CC}}=5\text{V}$	—	190	—	
t_{OFF}	Output Turn-Off Delay time	$V_{\text{CC}}=3.3\text{V}$	—	0.4	—	μs
		$V_{\text{CC}}=5\text{V}$	—	0.4	—	
t_{PGON}	Power Good Turn-on Time	$V_{\text{CC}}=3.3\text{V}$	—	1.25	—	ms
		$V_{\text{CC}}=5\text{V}$	—	1.05	—	
t_{PGOFF}	Power Good Turn-off Time	$V_{\text{CC}}=3.3\text{V}$	—	10	—	ns
		$V_{\text{CC}}=5\text{V}$	—	8	—	
SR	Output Slew Rate	$V_{\text{CC}}=3.3\text{V}$	—	23	—	kV/s
		$V_{\text{CC}}=5\text{V}$	—	24	—	
$V_{\text{IN}} = 12\text{V}$						
t_{ON}	Output Turn-On Delay time	$V_{\text{CC}}=3.3\text{V}$	—	190	—	μs
		$V_{\text{CC}}=5\text{V}$	—	180	—	
t_{OFF}	Output Turn-Off Delay time	$V_{\text{CC}}=3.3\text{V}$	—	0.4	—	μs
		$V_{\text{CC}}=5\text{V}$	—	0.4	—	
t_{PGON}	Power Good Turn-on Time	$V_{\text{CC}}=3.3\text{V}$	—	1.3	—	ms
		$V_{\text{CC}}=5\text{V}$	—	1.25	—	
t_{PGOFF}	Power Good Turn-off Time	$V_{\text{CC}}=3.3\text{V}$	—	10	—	ns
		$V_{\text{CC}}=5\text{V}$	—	8	—	
SR	Output Slew Rate	$V_{\text{CC}}=3.3\text{V}$	—	80	—	kV/s
		$V_{\text{CC}}=5\text{V}$	—	81	—	

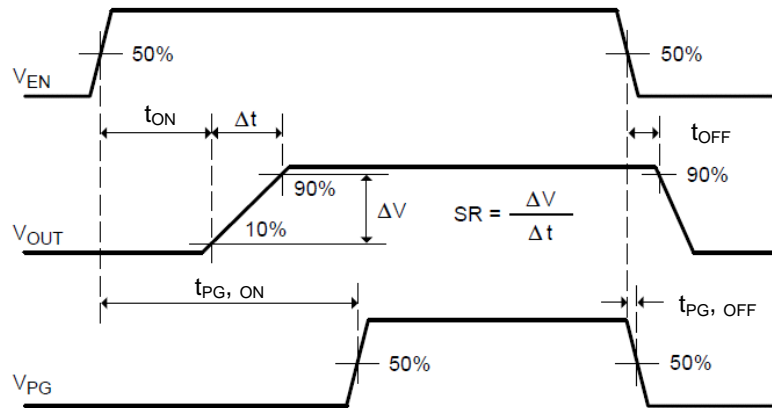
Figure 1 Timing Diagram

Performance Characteristics (@T_A = +25°C, unless otherwise specified.)

NEW PRODUCT

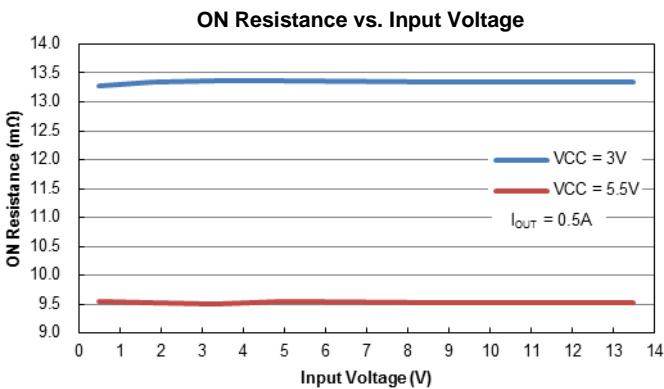
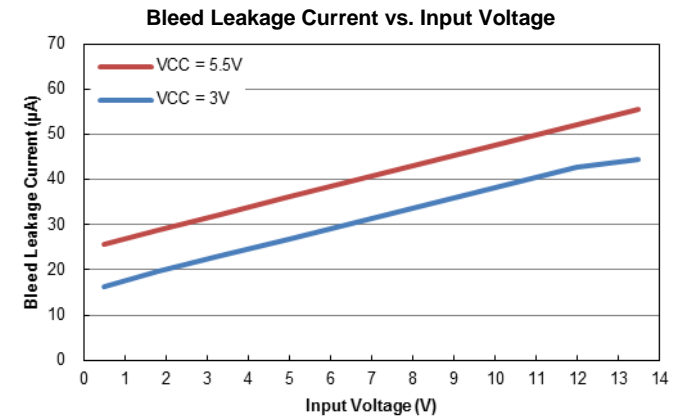
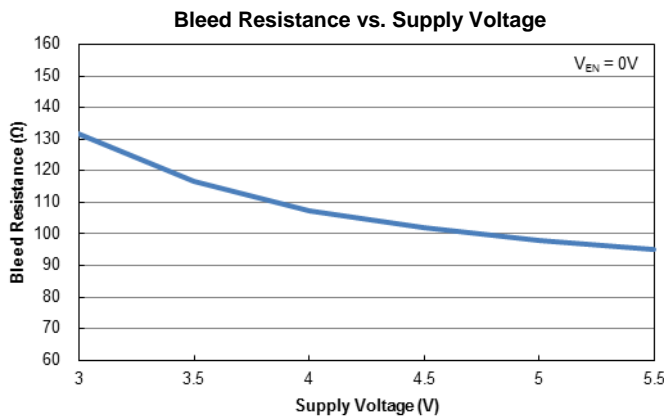
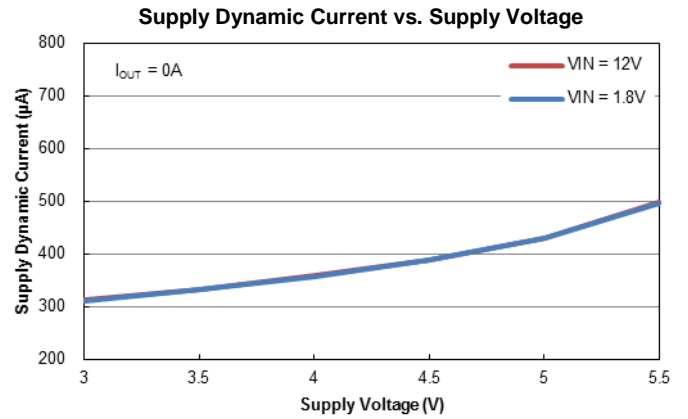
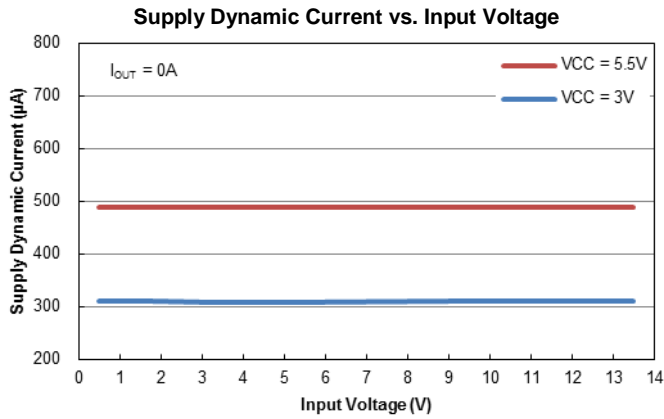

Performance Characteristics (@ $T_A = +25^\circ\text{C}$, unless otherwise specified.) (continued)

NEW PRODUCT

Turn ON Response

$V_{IN} = 1.8\text{V}$, $V_{CC} = 3.3\text{V}$, $V_{EN} = 0\text{V to } 3.3\text{V}$, $R_L = 10\Omega$

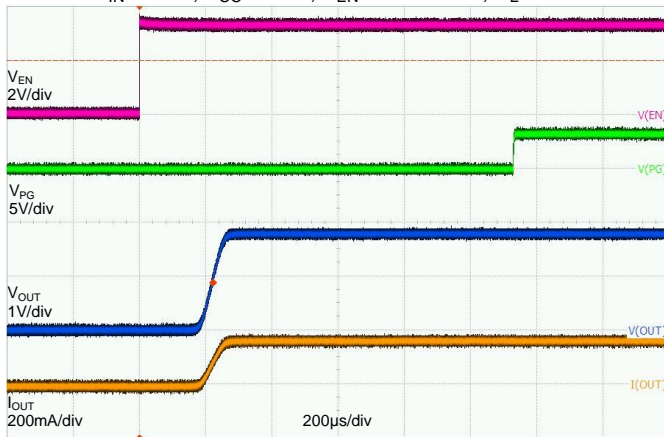

Turn OFF Response

$V_{IN} = 1.8\text{V}$, $V_{CC} = 3.3\text{V}$, $V_{EN} = 3.3\text{V to } 0\text{V}$, $R_L = 10\Omega$

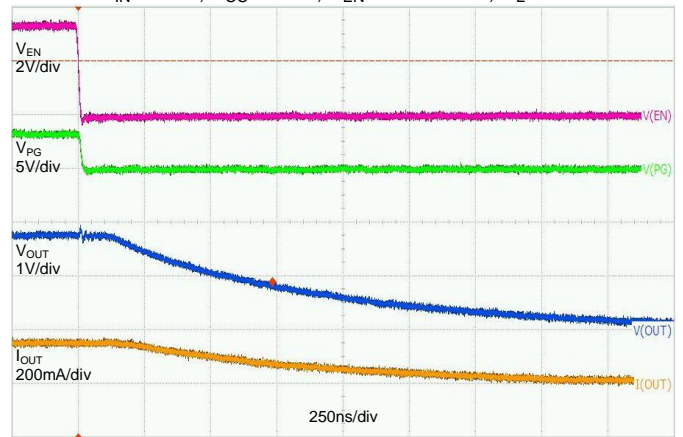

Turn ON Response

$V_{IN} = 5.0\text{V}$, $V_{CC} = 3.3\text{V}$, $V_{EN} = 0\text{V to } 3.3\text{V}$, $R_L = 10\Omega$

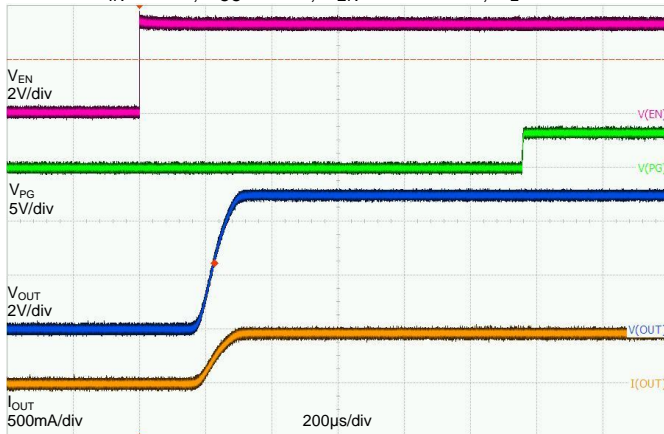

Turn OFF Response

$V_{IN} = 5.0\text{V}$, $V_{CC} = 3.3\text{V}$, $V_{EN} = 3.3\text{V to } 0\text{V}$, $R_L = 10\Omega$

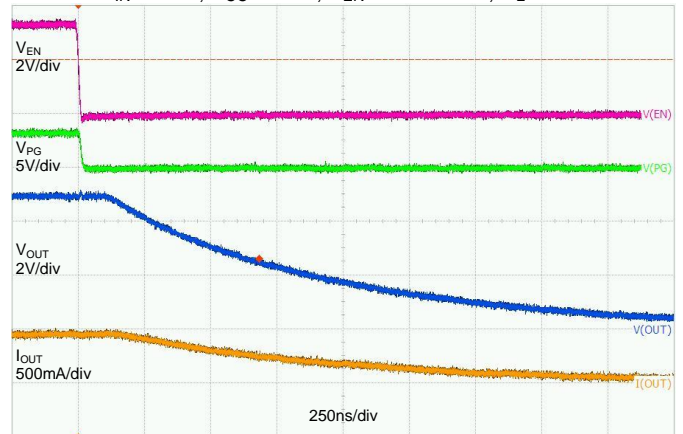

Turn ON Response

$V_{IN} = 12\text{V}$, $V_{CC} = 3.3\text{V}$, $V_{EN} = 0\text{V to } 3.3\text{V}$, $R_L = 10\Omega$

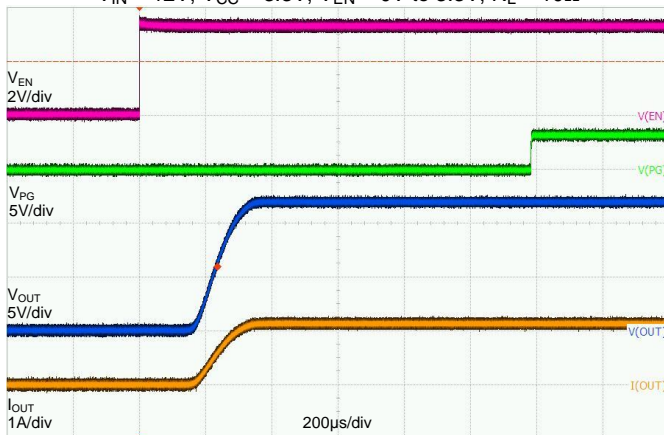

Turn OFF Response

$V_{IN} = 12\text{V}$, $V_{CC} = 3.3\text{V}$, $V_{EN} = 3.3\text{V to } 0\text{V}$, $R_L = 10\Omega$

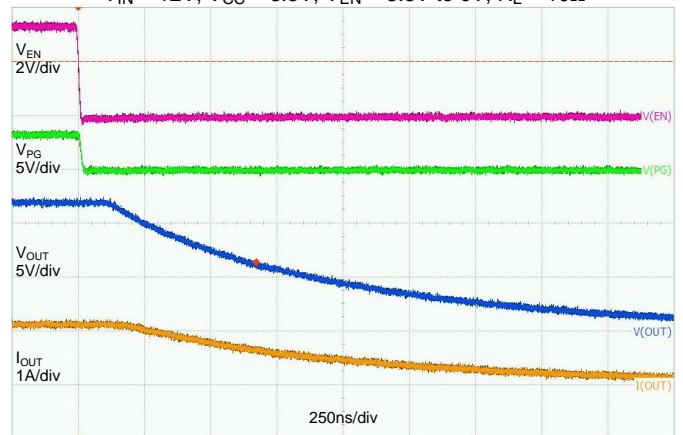

Performance Characteristics (@ $T_A = +25^\circ\text{C}$, unless otherwise specified.) (continued)

NEW PRODUCT

Turn ON Response

$V_{IN} = 1.8\text{V}$, $V_{CC} = 5.0\text{V}$, $V_{EN} = 0\text{V to } 3.3\text{V}$, $R_L = 10\Omega$

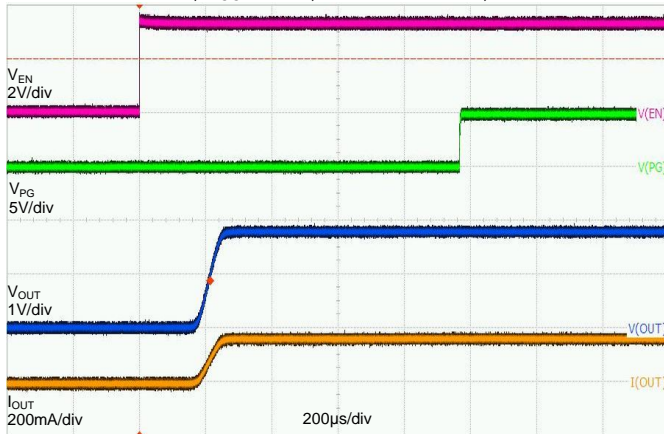

Turn OFF Response

$V_{IN} = 1.8\text{V}$, $V_{CC} = 5.0\text{V}$, $V_{EN} = 3.3\text{V to } 0\text{V}$, $R_L = 10\Omega$

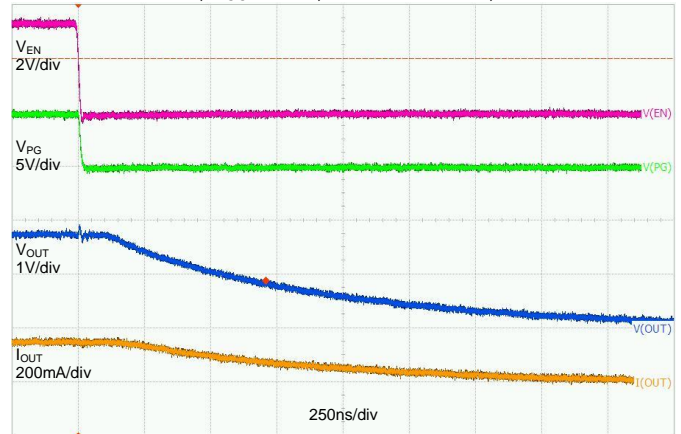

Turn ON Response

$V_{IN} = 5.0\text{V}$, $V_{CC} = 5.0\text{V}$, $V_{EN} = 0\text{V to } 3.3\text{V}$, $R_L = 10\Omega$

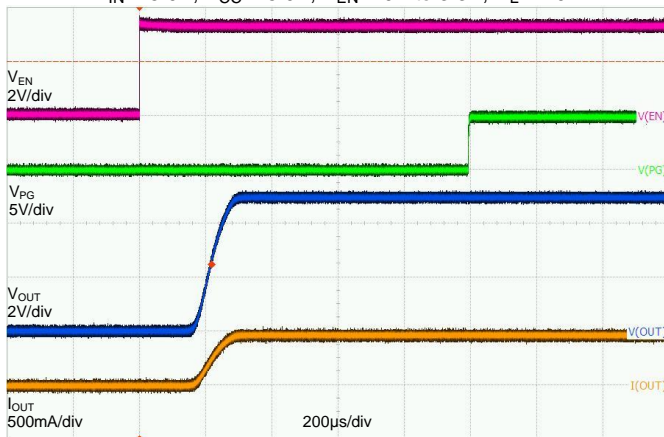

Turn OFF Response

$V_{IN} = 5.0\text{V}$, $V_{CC} = 5.0\text{V}$, $V_{EN} = 3.3\text{V to } 0\text{V}$, $R_L = 10\Omega$

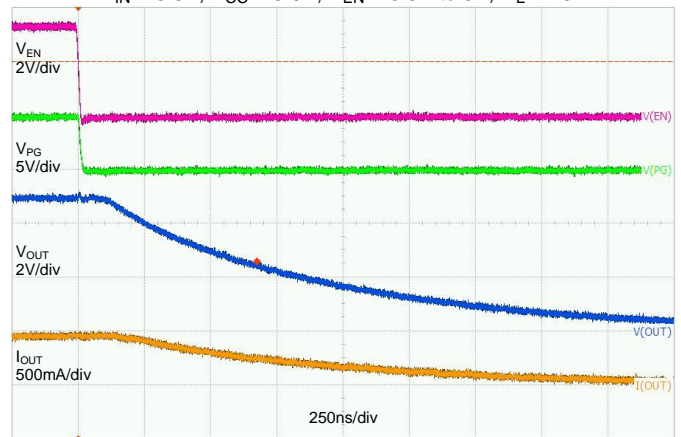

Turn ON Response

$V_{IN} = 12\text{V}$, $V_{CC} = 5.0\text{V}$, $V_{EN} = 0\text{V to } 3.3\text{V}$, $R_L = 10\Omega$

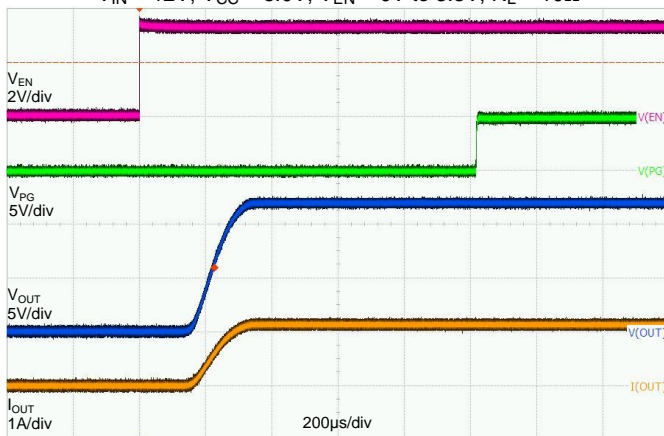

Turn OFF Response

$V_{IN} = 12\text{V}$, $V_{CC} = 5.0\text{V}$, $V_{EN} = 3.3\text{V to } 0\text{V}$, $R_L = 10\Omega$

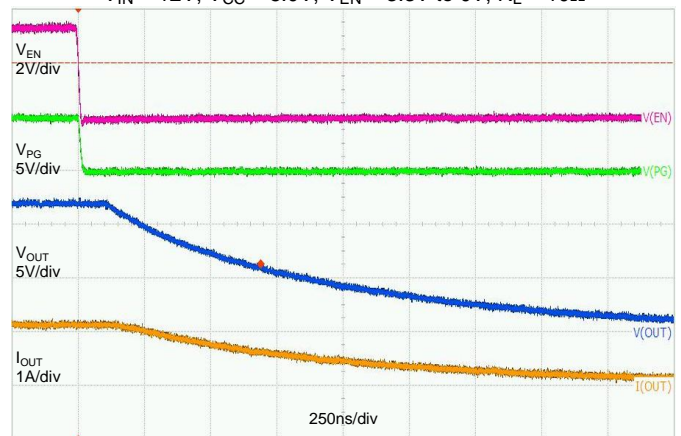

Application Information

General Description

The DML3006LFDS is a single channel load switch with a controlled adjustable turn-on and integrated PG indicator in an 8-pin V-DFN2020-8 (Type F) package. The device contains an N-channel MOSFET that can operate over an input voltage range of 0.5V to 13.5V and can support a maximum continuous current of 10A. The wide input voltage range and high current capability enable the device to be used across multiple designs and end equipment. 6mΩ On-resistance minimizes the voltage drop across the load switch and power loss from the load switch.

The controlled rise time for the device greatly reduces inrush current by large bulk load capacitances, thereby reducing or eliminating power supply droop. The adjustable slew rate through SR provides the design flexibility to trade off the inrush current and power up timing requirements. Integrated PG indicator notifies the system about the status of the load switch to facilitate seamless power sequencing. During shutdown, the device has very low leakage current, thereby reducing unnecessary leakages for downstream modules during standby. A 100Ω On-chip resistor is also embedded on the BLEED pin of DML3006LFDS for quick discharge of the output when switch is disabled.

Enable Control

The DML3006LFDS device allows for enabling the MOSFET in an active-high configuration. When the VCC supply pin has an adequate voltage applied and the EN pin is at logic high level, the MOSFET will be enabled. Similarly, when the EN pin is at logic low level, the MOSFET will be disabled. An internal pull down resistor to ground on the EN pin ensures that the MOSFET will be disabled when it is not being driven.

Power Sequencing

The DML3006LFDS functions with any power sequence, but the output turn-on delay performance can vary from what is specified. To achieve the specified performance that we recommended power sequences is:

$$V_{VCC} \rightarrow V_{VIN} \rightarrow V_{EN}$$

Load Bleed (Quick Discharge)

The DML3006LFDS has an internal bleed discharge device which is used to bleed the charge off of the load to ground after the MOSFET has been disabled. The bleed discharge device is enabled whenever the MOSFET is disabled. The MOSFET and the bleed device are never concurrently active.

It is required that the BLEED pin be connected to V_{OUT} either directly or through an external resistor, R_{EXT} . The R_{EXT} should not exceed 1kΩ and can be used to increase the total bleed resistance.

Care must be taken to ensure that the power dissipated across R_{BLEED} is kept at safe level. The maximum continuous power that can be dissipates across R_{BLEED} is 0.4W. R_{EXT} can be used to decrease the amount of power dissipated across R_{BLEED} .

Power Good

The DML3006LFDS device has a power good output (PG) that can be used to indicate when the gate of the MOSFET is driven high and the switch is on with the On-resistance close to its final value (at the full load condition). The PG pin is an active-high, open-drain output that requires an external pull up resistor, R_{PG} , greater than or equal to 1kΩ to an external voltage source, V_{TERM} , compatible with input levels of those devices connected to this pin.

The power good output can be used as the enable signal for other active-high devices in the system. This allows for guaranteed by design power sequencing and reduces the number of enable signals needed from the system controller. If the power good feature is not used in the application, the PG pin should be tied to GND.

Short Circuit Protection

The DML3006LFDS is equipped with short-circuit protection that is used to help protect the part and the system from a sudden high-current event, such as the output, V_{OUT} , being shorted to ground. This circuitry is only active when the gate of MOSFET is fully charged.

Once active, the circuitry monitors the difference in the voltage on the V_{IN} pin and the voltage on the BLEED pin. In order for the V_{OUT} voltage to be monitored through the BLEED pin, it is required that BLEED pin be connected to V_{OUT} either directly or through a resistor, R_{EXT} , which should not exceed 1kΩ. Once the BLEED pin is connected to V_{OUT} , the short-circuit protection will be activated to monitor the voltage drop across the MOSFET.

If the voltage drop across the MOSFET is greater than or equal to the short-circuit protection threshold voltage, the MOSFET is immediately turned off and the load bleed is activated. The part remains latched in this off state until EN is toggled or VCC supply voltage is cycled, at which point the MOSFET will be turn-on delay and slew rate. The current through the MOSFET that will cause a short-circuit event can be calculated by dividing the short-circuit protection threshold by expected on-resistance of the MOSFET.

Application Information (continued)

Thermal Shutdown

The DML3006LFDS is equipped with thermal shutdown protection for internal or external generated excessive temperatures. This circuitry is disabled when EN is not active to reduce standby current. When an over-temperature condition is detected, the MOSFET is immediately turned off and the load bleed is active.

The part comes out of thermal shutdown when the junction temperature decreases to a safe operating temperature as dictated by the thermal hysteresis. Upon exiting a thermal shutdown state, and if EN remains active, the MOSFET will be turned on in a controlled fashion with the normal output turn-on delay and slew rate.

Undervoltage Lockout

The DML3006LFDS is also equipped with undervoltage lockout protection. The DML3006LFDS turns the MOSFET off and activates the load bleed when the input voltage, V_{IN} , is less than or equal to the undervoltage lockout threshold. This circuitry is disabled when EN is not active to reduce standby current.

If the V_{IN} voltage rises above the undervoltage lockout threshold and EN remains active, the MOSFET will be turned on in a controlled fashion with the normal output turn-on delay and slew rate.

PCB Layout Consideration

1. Place the input/output capacitors C_{VIN} and C_{VOUT} as close as possible to the V_{IN} and V_{OUT} pins.
2. The power traces which are V_{IN} trace, V_{OUT} trace and GND trace should be short, wide and direct for minimizing parasitic inductance.
3. Place feedback resistance R_{BLEED} as close as possible to BLEED pin.
4. Place C_{VCC} capacitor near the device pin.
5. Connect the signal ground to the GND pin, and keep a single connection from GND pin to the power ground behind the input or output capacitors.
6. For better power dissipation, via holes are recommended to connect the exposed pad's landing area to a large copper polygon on the other side of the printed circuit board. The copper polygons and exposed pad shall connect to V_{IN} pin on the printed circuit board.

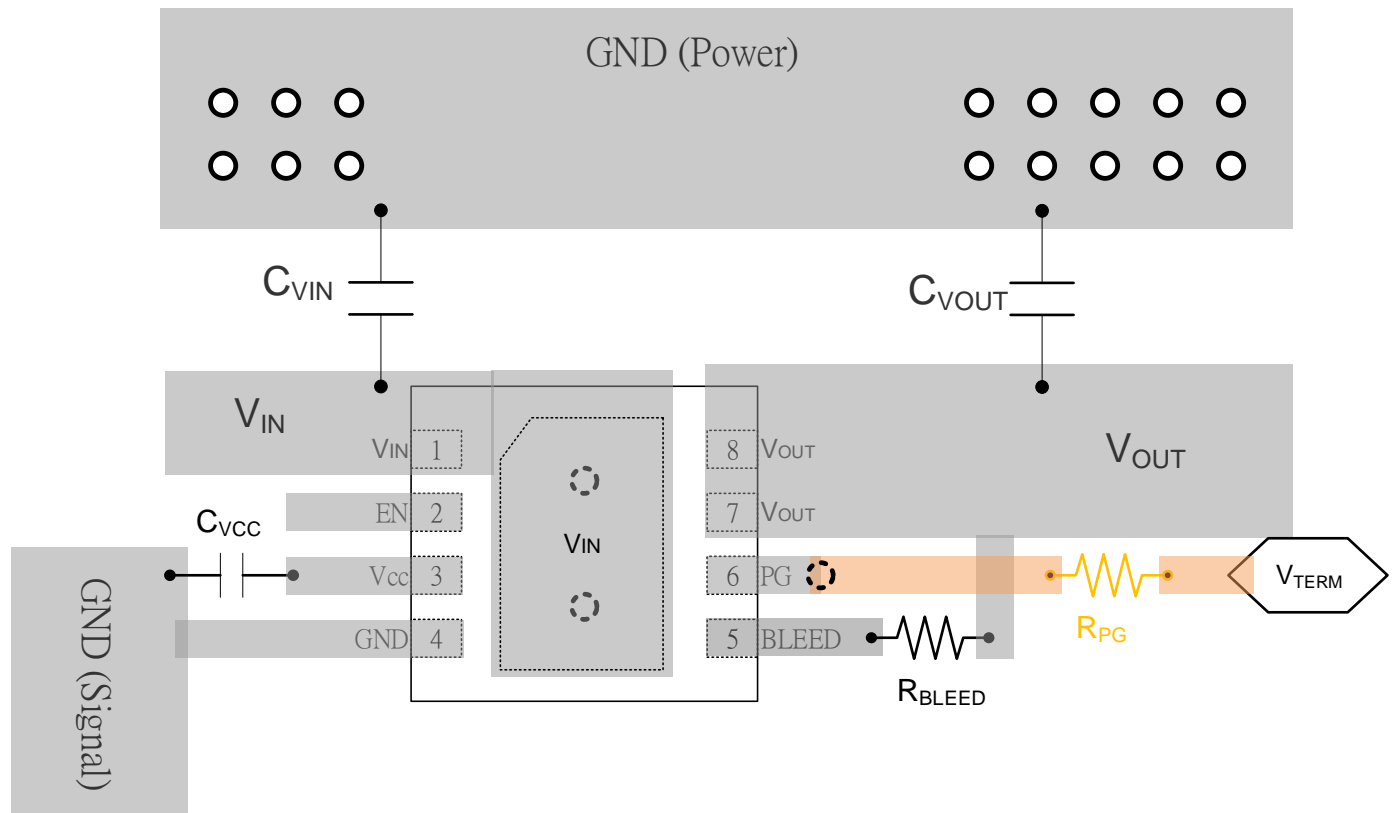

Package Outline Dimensions

Please see <http://www.diodes.com/package-outlines.html> for the latest version.

V-DFN2020-8 (Type F)

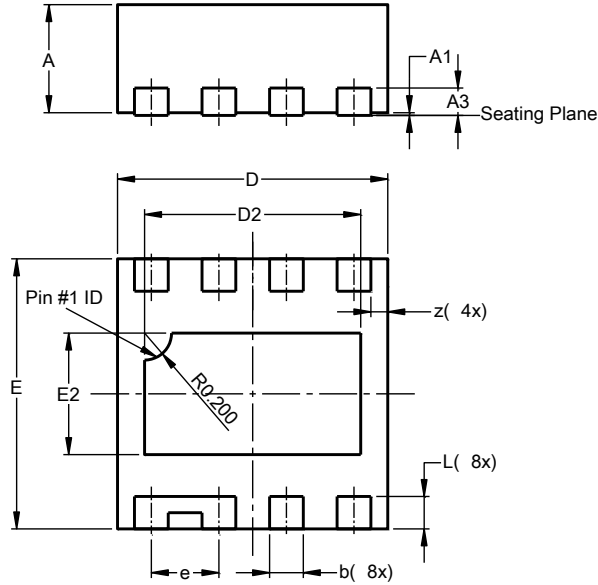

V-DFN2020-8 (Type F)			
Dim	Min	Max	T p
A	0.77	0.85	0.80
A1	0.00	0.05	0.02
A3	--	--	0.203
b	0.20	0.30	0.25
D	1.95	2.05	2.00
D2	1.50	1.70	1.60
E	1.95	2.05	2.00
E2	0.80	1.00	0.90
e	--	--	0.50
L	0.19	0.29	0.24
z	--	--	0.125
All Dimensions in mm			

NEW PRODUCT

Suggested Pad Layout

Please see <http://www.diodes.com/package-outlines.html> for the latest version.

V-DFN2020-8 (Type F)

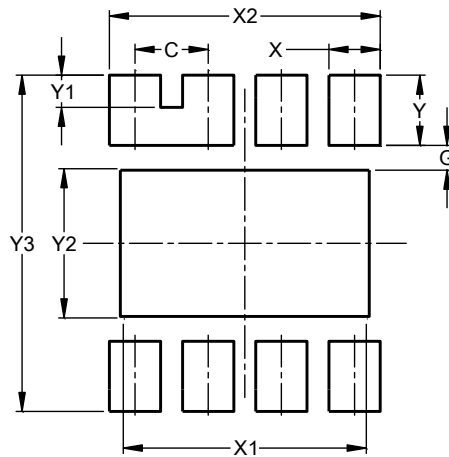

Dimensions	Value (in mm)
C	0.500
G	0.170
X	0.350
X1	1.660
X2	1.850
Y	0.480
Y1	0.220
Y2	1.020
Y3	2.300

IMPORTANT NOTICE

DIODES INCORPORATED MAKES NO WARRANTY OF ANY KIND, EXPRESS OR IMPLIED, WITH REGARDS TO THIS DOCUMENT, INCLUDING, BUT NOT LIMITED TO, THE IMPLIED WARRANTIES OF MERCHANTABILITY AND FITNESS FOR A PARTICULAR PURPOSE (AND THEIR EQUIVALENTS UNDER THE LAWS OF ANY JURISDICTION).

Diodes Incorporated and its subsidiaries reserve the right to make modifications, enhancements, improvements, corrections or other changes without further notice to this document and any product described herein. Diodes Incorporated does not assume any liability arising out of the application or use of this document or any product described herein; neither does Diodes Incorporated convey any license under its patent or trademark rights, nor the rights of others. Any Customer or user of this document or products described herein in such applications shall assume all risks of such use and will agree to hold Diodes Incorporated and all the companies whose products are represented on Diodes Incorporated website, harmless against all damages.

Diodes Incorporated does not warrant or accept any liability whatsoever in respect of any products purchased through unauthorized sales channel. Should Customers purchase or use Diodes Incorporated products for any unintended or unauthorized application, Customers shall indemnify and hold Diodes Incorporated and its representatives harmless against all claims, damages, expenses, and attorney fees arising out of, directly or indirectly, any claim of personal injury or death associated with such unintended or unauthorized application.

Products described herein may be covered by one or more United States, international or foreign patents pending. Product names and markings noted herein may also be covered by one or more United States, international or foreign trademarks.

This document is written in English but may be translated into multiple languages for reference. Only the English version of this document is the final and determinative format released by Diodes Incorporated.

LIFE SUPPORT

Diodes Incorporated products are specifically not authorized for use as critical components in life support devices or systems without the express written approval of the Chief Executive Officer of Diodes Incorporated. As used herein:

A. Life support devices or systems are devices or systems which:

1. are intended to implant into the body, or
2. support or sustain life and whose failure to perform when properly used in accordance with instructions for use provided in the labeling can be reasonably expected to result in significant injury to the user.

B. A critical component is any component in a life support device or system whose failure to perform can be reasonably expected to cause the failure of the life support device or to affect its safety or effectiveness.

Customers represent that they have all necessary expertise in the safety and regulatory ramifications of their life support devices or systems, and acknowledge and agree that they are solely responsible for all legal, regulatory and safety-related requirements concerning their products and any use of Diodes Incorporated products in such safety-critical, life support devices or systems, notwithstanding any devices- or systems-related information or support that may be provided by Diodes Incorporated. Further, Customers must fully indemnify Diodes Incorporated and its representatives against any damages arising out of the use of Diodes Incorporated products in such safety-critical, life support devices or systems.

Copyright © 2019, Diodes Incorporated

www.diodes.com

X-ON Electronics

Largest Supplier of Electrical and Electronic Components

Click to view similar products for [Power Switch ICs - Power Distribution](#) *category:*

Click to view products by [Diodes Incorporated](#) *manufacturer:*

Other Similar products are found below :

[TCK111G,LF\(S\)](#) [FPF1018](#) [DS1222](#) [TCK2065G,LF](#) [SZNCP3712ASNT3G](#) [MIC2033-05BYMT-T5](#) [MIC2033-12AYMT-T5](#) [MIC2033-05BYM6-T5](#) [SLG5NT1437VTR](#) [SZNCP3712ASNT1G](#) [DML1008LDS-7](#) [KTS1670EDA-TR](#) [KTS1640QGDV-TR](#) [KTS1641QGDV-TR](#) [U6513A](#) [MIC2012YM-TR](#) [MP5095GJ-P](#) [TPS2021IDRQ1](#) [TPS2104DBVR](#) [MIC2098-1YMT-TR](#) [MIC94062YMT TR](#) [MIC2015-1.2YM6 TR](#) [MIC2075-2YM](#) [MIC94068YML-TR](#) [SIP32461DB-T2-GE1](#) [NCP335FCT2G](#) [FPF1504UCX](#) [TCK105G,LF\(S\)](#) [AP2411S-13](#) [AP2151DSG-13](#) [AP2172MPG-13](#) [MIC94094YC6-TR](#) [MIC94093YC6-TR](#) [MIC94064YC6-TR](#) [MIC94061YMT-TR](#) [MIC2505-1YM](#) [MIC94085YFT-TR](#) [MIC94042YFL-TR](#) [MIC2005-1.2YM6-TR](#) [SIP32510DT-T1-GE3](#) [NCP333FCT2G](#) [NCP331SNT1G](#) [TPS2092DR](#) [TPS2063DR](#) [MIC2008YML-TR](#) [MIC94084YFT-TR](#) [DIO1280WL12](#) [BTS70202EPAXUMA1](#) [AP22814ASN-7](#) [MIC2043-2YTS](#)