

Description

This Bipolar Junction Transistor (BJT) is designed to meet the stringent requirements of automotive applications.

Features

- $BV_{CE0} > -60V$
- $I_C = -3A$ High Continuous Collector Current
- I_{CM} up to $-6A$ Peak Pulse Current
- 2W Power Dissipation
- Complementary PNP Type: DXT651Q
- **Totally Lead-Free & Fully RoHS Compliant (Notes 1 & 2)**
- **Halogen and Antimony Free. "Green" Device (Note 3)**
- **Qualified to AEC-Q101 Standards for High Reliability**
- **PPAP Capable (Note 4)**

Mechanical Data

- Case: SOT89
- Case Material: Molded Plastic. "Green" Molding Compound.
- UL Flammability Rating 94V-0
- Moisture Sensitivity: Level 1 per J-STD-020
- Terminals: Finish - Matte Tin Plated Leads, Solderable per MIL-STD-202, Method 208
- Weight: 0.052 grams (Approximate)

SOT89



Top View

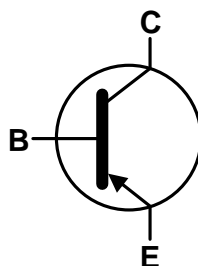

Device Symbol

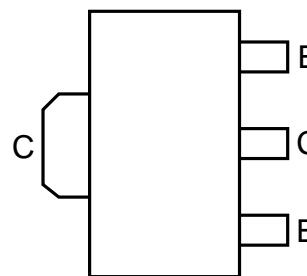

Top View
Pinout

Ordering Information (Notes 4 & 5)

Product	Compliance	Marking	Reel size (inches)	Tape width (mm)	Quantity per reel
DXT751Q-13	Automotive	KP2	13	12	2,500

- Notes:
1. No purposely added lead. Fully EU Directive 2002/95/EC (RoHS) & 2011/65/EU (RoHS 2) compliant.
 2. See http://www.diodes.com/quality/lead_free.html for more information about Diodes Incorporated's definitions of Halogen and Antimony free, "Green" and Lead-Free.
 3. Halogen and Antimony free "Green" products are defined as those which contain <900ppm bromine, <900ppm chlorine (<1500ppm total Br + Cl) and <1000ppm antimony compounds.
 4. Automotive products are AEC-Q101 qualified and are PPAP capable. Refer to http://www.diodes.com/product_compliance_definitions.html.
 5. For packaging details, go to our website at <http://www.diodes.com/products/packages.html>.

Marking Information

SOT89



KP2 = Product Type Marking Code
 = Manufacturer's Marking Code
 YWW = Date Code Marking
 Y = Last digit of year (ex: 6 = 2016)
 WW = Week code (01 – 53)

Absolute Maximum Ratings (@T_A = +25°C, unless otherwise specified.)

Characteristic	Symbol	Value	Unit
Collector-Base Voltage	V _{CBO}	-80	V
Collector-Emitter Voltage	V _{CEO}	-60	V
Emitter-Base Voltage	V _{EBO}	-5	V
Collector Current	I _C	-3	A
Peak Pulse Collector Current	I _{CM}	-6	A

Thermal Characteristics (@T_A = +25°C, unless otherwise specified.)

Characteristic	Symbol	Value	Unit
Power Dissipation	P _D	1	W
		2	
Thermal Resistance, Junction to Ambient Air	R _{θJA}	125	°C/W
		62.5	
Thermal Resistance, Junction to Leads	R _{θJL}	6.0	°C/W
Operating and Storage Temperature Range	T _J , T _{STG}	-55 to +150	°C

- Notes:
- 6. For a device surface mounted on 15mm x 15mm x 0.6mm FR4 PCB with high coverage of single sided 1 oz copper, in still air conditions; the device is measured when operating in steady state condition.
 - 7. Same as note (5), except the device is mounted on 40mm x 40mm x 1.6mm FR4 PCB.
 - 8. Thermal resistance from junction to solder-point (on the exposed collector pad).

Thermal Characteristics and Derating Information

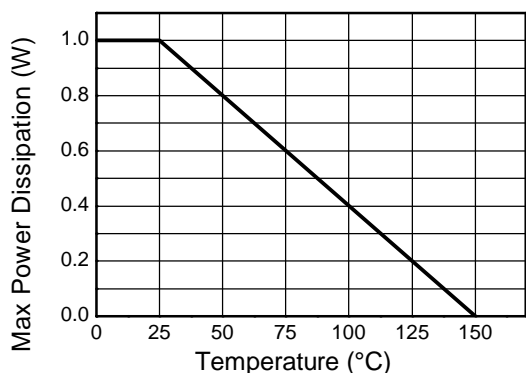

Derating Curve

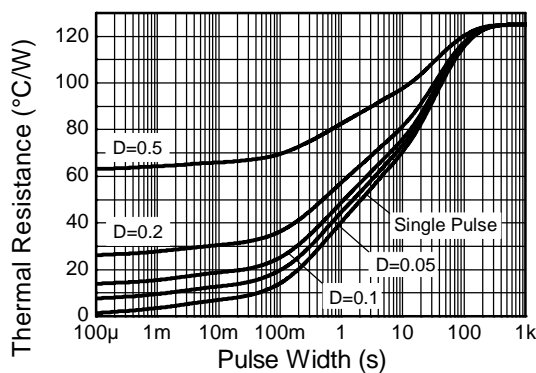

Transient Thermal Impedance

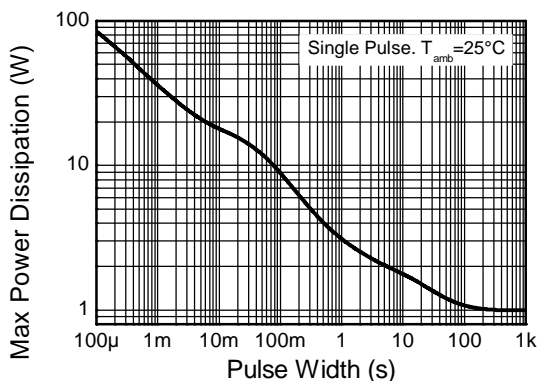

Pulse Power Dissipation

Electrical Characteristics (@T_A = +25°C, unless otherwise specified.)

Characteristic	Symbol	Min	Typ	Max	Unit	Test Conditions
OFF CHARACTERISTICS						
Collector-Base Breakdown Voltage	BV _{CB0}	-80	—	—	V	I _C = -100μA
Collector-Emitter Breakdown Voltage (Note 9)	BV _{CEO}	-60	—	—	V	I _C = -10mA
Emitter-Base Breakdown Voltage	BV _{EBO}	-5	—	—	V	I _E = -100μA
Collector-Base Cutoff Current	I _{CB0}	—	—	-0.1 -10	μA	V _{CB} = -60V V _{CB} = -60V, T _A = +100°C
Emitter-Base Cutoff Current	I _{EBO}	—	—	-0.1	μA	V _{EB} = -4V
ON CHARACTERISTICS (Note 9)						
Collector-Emitter Saturation Voltage	V _{CE(sat)}	—	-0.08 -0.2	-0.3 -0.6	V	I _C = -1A, I _B = 100mA I _C = -3A, I _B = 300mA
Base-Emitter Saturation Voltage	V _{BE(sat)}	—	-0.90	-1.25	V	I _C = -1A, I _B = -100mA
Base-Emitter Turn-On Voltage	V _{BE(on)}	—	-0.8	-1	V	V _{CE} = -2V, I _C = -1A
DC Current Gain	h _{FE}	70 100 80 40	200 180 160 140	— 300 — —	—	V _{CE} = -2V, I _C = -50mA V _{CE} = -2V, I _C = -500mA V _{CE} = -2V, I _C = -1A V _{CE} = -2V, I _C = -2A
SMALL-SIGNAL CHARACTERISTICS						
Transition Frequency	f _T	100	145	—	MHz	V _{CE} = -10V, I _C = -50mA, f = 100MHz
Output Capacitance	C _{obo}	—	—	30	pF	V _{CB} = -10V, f = 1MHz
Switching Times	t _{on} t _{off}	— —	45 200	— —	ns ns	V _{CC} = -10V, I _C = -500mA, I _{B1} = -I _{B2} = -50mA

Note: 9. Measured under pulsed conditions. Pulse width ≤ 300μs. Duty cycle ≤ 2%.

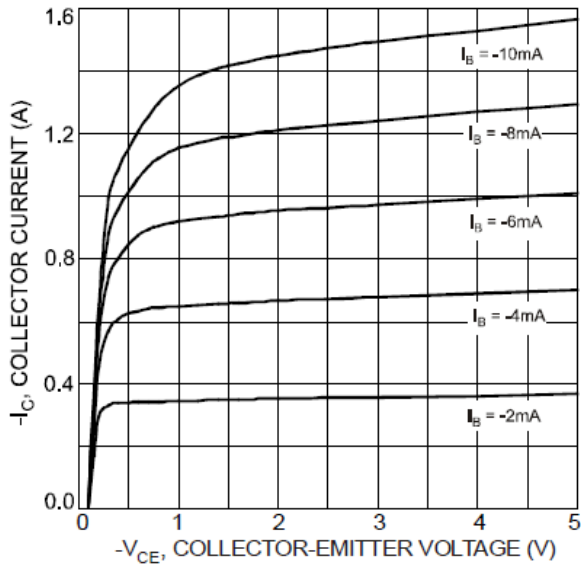

Fig. 2 Typical Collector Current vs. Collector-Emitter Voltage

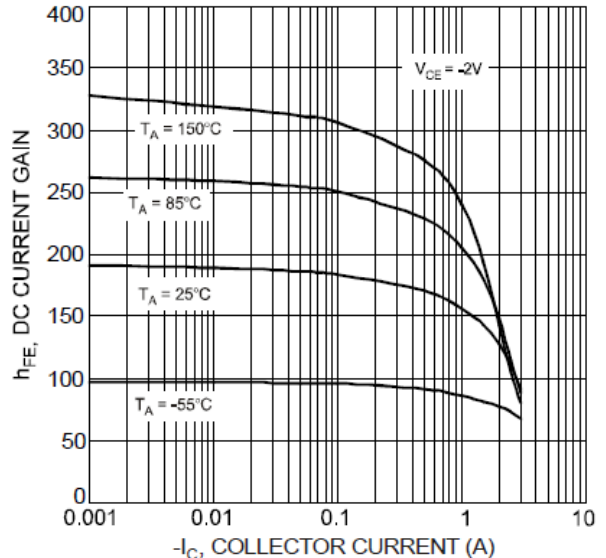

Fig. 3 Typical DC Current Gain vs. Collector Current

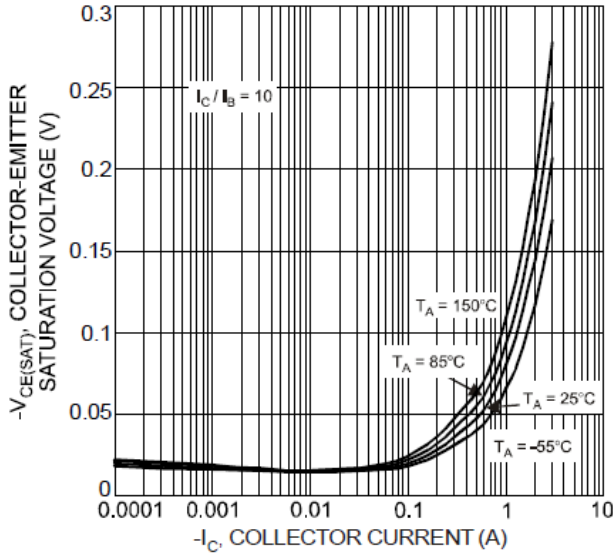

Fig. 4 Typical Collector-Emitter Saturation Voltage vs. Collector Current

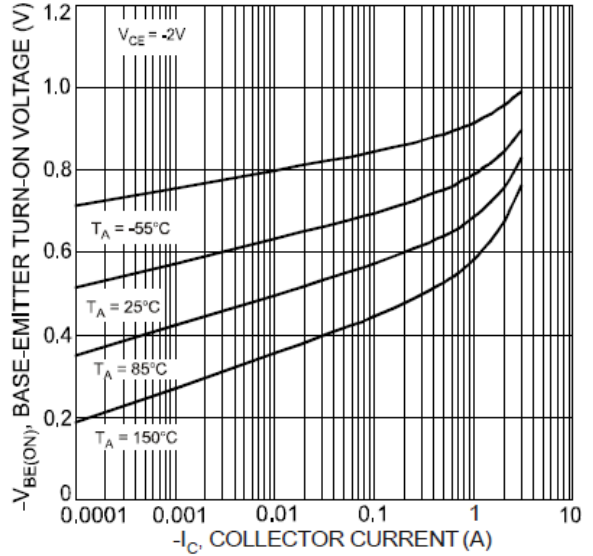

Fig. 5 Typical Base-Emitter Turn-On Voltage vs. Collector Current

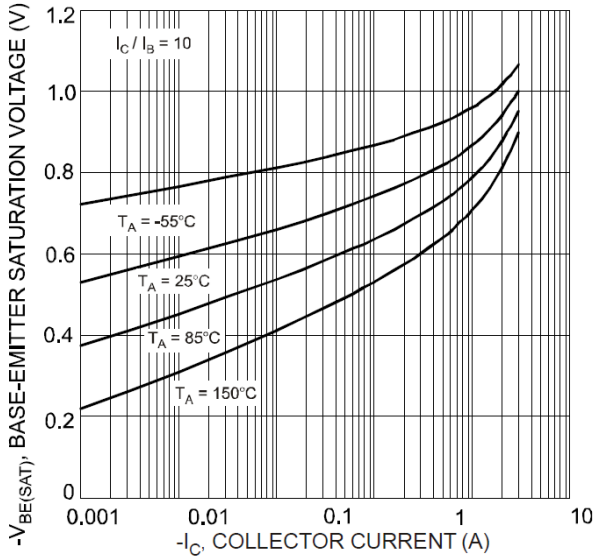

Fig. 6 Typical Base-Emitter Saturation Voltage vs. Collector Current

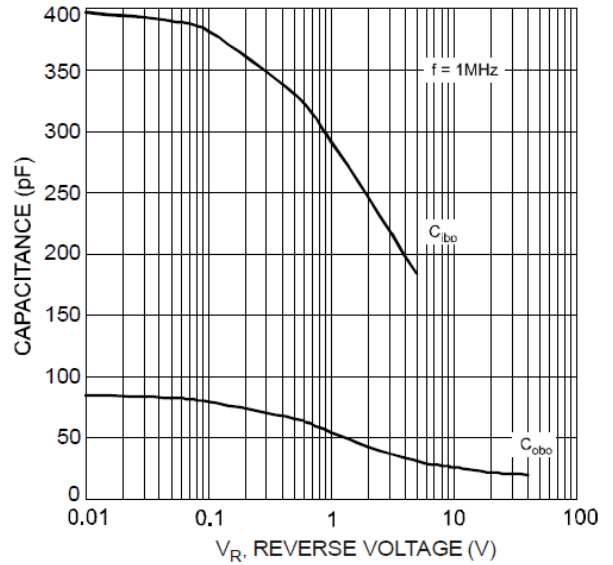

Fig. 7 Typical Capacitance Characteristics

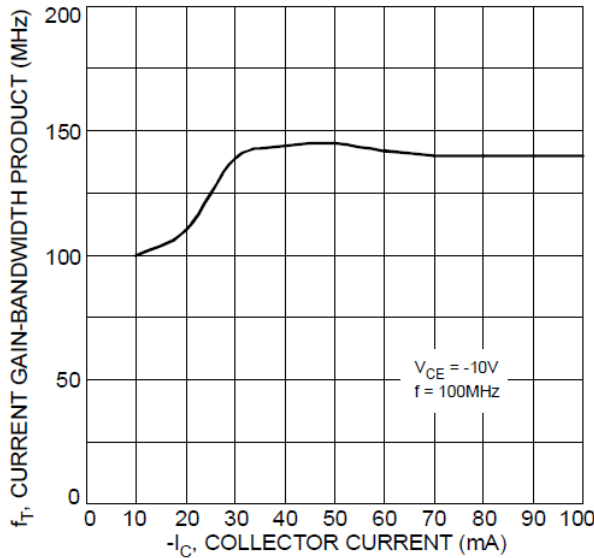
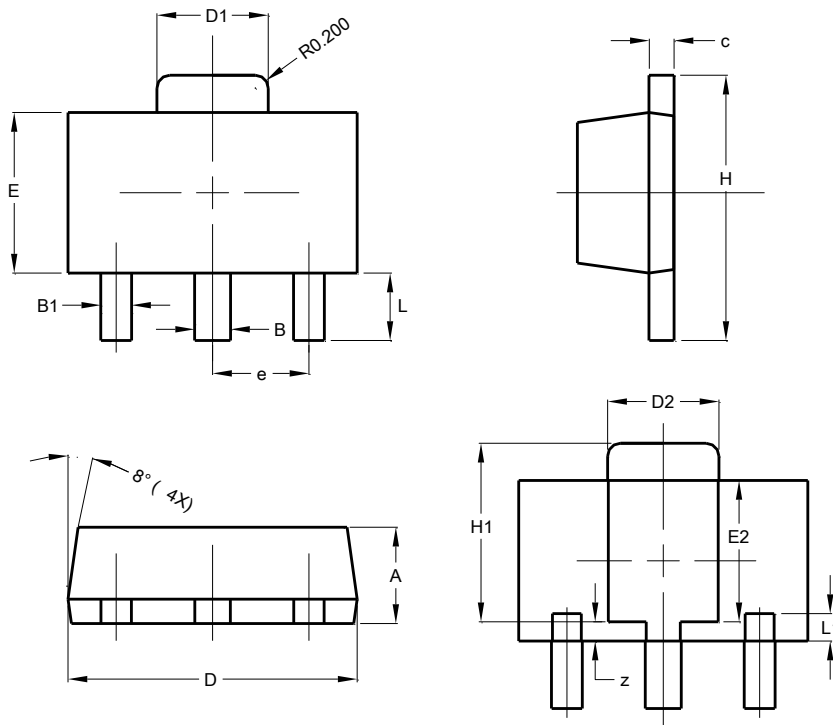

Fig. 8 Typical Gain-Bandwidth Product vs. Collector Current

Package Outline Dimensions

Please see <http://www.diodes.com/package-outlines.html> for the latest version.



SOT89			
Dim	Min	Max	Typ
A	1.40	1.60	1.50
B	0.50	0.62	0.56
B1	0.42	0.54	0.48
c	0.35	0.43	0.38
D	4.40	4.60	4.50
D1	1.62	1.83	1.733
D2	1.61	1.81	1.71
E	2.40	2.60	2.50
E2	2.05	2.35	2.20
e	-	-	1.50
H	3.95	4.25	4.10
H1	2.63	2.93	2.78
L	0.90	1.20	1.05
L1	0.327	0.527	0.427
z	0.20	0.40	0.30
All Dimensions in mm			

Suggested Pad Layout

Please see <http://www.diodes.com/package-outlines.html> for the latest version.

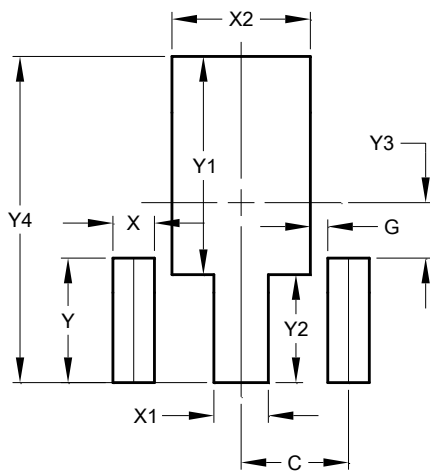

Dimensions	Value (in mm)
C	1.500
G	0.244
X	0.580
X1	0.760
X2	1.933
Y	1.730
Y1	3.030
Y2	1.500
Y3	0.770
Y4	4.530

IMPORTANT NOTICE

DIODES INCORPORATED MAKES NO WARRANTY OF ANY KIND, EXPRESS OR IMPLIED, WITH REGARDS TO THIS DOCUMENT, INCLUDING, BUT NOT LIMITED TO, THE IMPLIED WARRANTIES OF MERCHANTABILITY AND FITNESS FOR A PARTICULAR PURPOSE (AND THEIR EQUIVALENTS UNDER THE LAWS OF ANY JURISDICTION).

Diodes Incorporated and its subsidiaries reserve the right to make modifications, enhancements, improvements, corrections or other changes without further notice to this document and any product described herein. Diodes Incorporated does not assume any liability arising out of the application or use of this document or any product described herein; neither does Diodes Incorporated convey any license under its patent or trademark rights, nor the rights of others. Any Customer or user of this document or products described herein in such applications shall assume all risks of such use and will agree to hold Diodes Incorporated and all the companies whose products are represented on Diodes Incorporated website, harmless against all damages.

Diodes Incorporated does not warrant or accept any liability whatsoever in respect of any products purchased through unauthorized sales channel. Should Customers purchase or use Diodes Incorporated products for any unintended or unauthorized application, Customers shall indemnify and hold Diodes Incorporated and its representatives harmless against all claims, damages, expenses, and attorney fees arising out of, directly or indirectly, any claim of personal injury or death associated with such unintended or unauthorized application.

Products described herein may be covered by one or more United States, international or foreign patents pending. Product names and markings noted herein may also be covered by one or more United States, international or foreign trademarks.

This document is written in English but may be translated into multiple languages for reference. Only the English version of this document is the final and determinative format released by Diodes Incorporated.

LIFE SUPPORT

Diodes Incorporated products are specifically not authorized for use as critical components in life support devices or systems without the express written approval of the Chief Executive Officer of Diodes Incorporated. As used herein:

A. Life support devices or systems are devices or systems which:

1. are intended to implant into the body, or
2. support or sustain life and whose failure to perform when properly used in accordance with instructions for use provided in the labeling can be reasonably expected to result in significant injury to the user.

B. A critical component is any component in a life support device or system whose failure to perform can be reasonably expected to cause the failure of the life support device or to affect its safety or effectiveness.

Customers represent that they have all necessary expertise in the safety and regulatory ramifications of their life support devices or systems, and acknowledge and agree that they are solely responsible for all legal, regulatory and safety-related requirements concerning their products and any use of Diodes Incorporated products in such safety-critical, life support devices or systems, notwithstanding any devices- or systems-related information or support that may be provided by Diodes Incorporated. Further, Customers must fully indemnify Diodes Incorporated and its representatives against any damages arising out of the use of Diodes Incorporated products in such safety-critical, life support devices or systems.

Copyright © 2016, Diodes Incorporated

www.diodes.com

X-ON Electronics

Largest Supplier of Electrical and Electronic Components

Click to view similar products for [Bipolar Transistors - BJT category](#):

Click to view products by [Diodes Incorporated manufacturer](#):

Other Similar products are found below :

[619691C](#) [MCH4017-TL-H](#) [BC546/116](#) [BC557/116](#) [BSW67A](#) [NTE187A](#) [NTE195A](#) [NTE2302](#) [NTE2330](#) [NTE63](#) [C4460](#) [2SA1419T-TD-H](#)
[2SA1721-O\(TE85L,F\)](#) [2SA2126-E](#) [2SB1204S-TL-E](#) [2SC5488A-TL-H](#) [2SD2150T100R](#) [SP000011176](#) [2N2369ADCSM](#) [2SC2412KT146S](#)
[2SC5490A-TL-H](#) [2SD1816S-TL-E](#) [2SD1816T-TL-E](#) [CMXT2207 TR](#) [CPH6501-TL-E](#) [MCH4021-TL-E](#) [US6T6TR](#) [732314D](#) [CMXT3906 TR](#)
[CPH3121-TL-E](#) [CPH6021-TL-H](#) [873787E](#) [UMX21NTR](#) [EMT2T2R](#) [MCH6102-TL-E](#) [FP204-TL-E](#) [NJL0302DG](#) [2N3583](#) [2N3879](#)
[2SA1434-TB-E](#) [2SC3143-4-TB-E](#) [2SD1621S-TD-E](#) [30A02MH-TL-E](#) [NSV40301MZ4T1G](#) [NTE13](#) [NTE15](#) [NTE16001](#) [NTE16006](#) [NTE26](#)
[NTE320](#)