

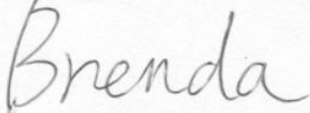

PSE Technology Corporation

SPECIFICATION FOR APPROVAL

CUSTOMER	_____
NOMINAL FREQUENCY	32.768 KHz
PRODUCT TYPE	TYPE G4 SMD X'TAL
SPEC. NO. (P/N)	G43270021
CUSTOMER P/N	_____
ISSUE DATE	Nov.8,2012
VERSION	B

APPROVED	PREPARED	QA
		
APPROVED BY CUSTOMER :		AVL Status
Please return one copy with approval to PSE-TW		

PSE Technology Corporation

No.2, Tzu-Chiang 5th Rd, Chung Li Industrial Park,
 Chung Li City, Taoyuan County, Taiwan (R.O.C.)
 TEL: 886-3-451-8888
 FAX: 886-3-461-3865
<http://www.saronix-ecera.com.tw>

*RoHS Exception
 *HF-Halogen Free
 *REACH Compliant

TYPE G4 SMD X'TAL

G43270021

VER. B 8-Nov-12

ELECTRICAL SPECIFICATIONS

SRe Part Number : G43270021

Parameters	Symbol	Specifications	Units	Notes
Nominal Frequency	Fn	32.768	KHz	
Frequency Tolerance	FT	± 20	ppm	at 25 °C ± 5 °C
Load Capacitance	CL	12.5	pF	Typ.
Drive Level	DL	1	μW	Max.
Equivalent Series Resistance	ESR	50	KΩ	Max.
Temperature Coefficient	K	-0.035 ± 0.01	ppm/°C ²	
Shunt Capacitance	C0	1.6	pF	Typ.
Operating Temperature Range	TR	-40~85	°C	
Storage Temperature Range		-55~85	°C	
Aging		± 5	ppm	Max 1st year
Insulation Resistance		500	MΩ	Min.

Reliability (Mechanical and Environmental Endurance)

No.	Test Items	Test Method and Condition	Requirements
1	Vibration	(1) Vibration Frequency: 10 to 55Hz (2) Vibration Amplitude: 1.5mm (3) Cycle Time: 1-2min(10-55-10Hz) (4) Direction: X.Y.Z (5) Duration: 2h/each direction	Frequency Change: ±10ppm Max. Resistance Change: ±15% or 5kΩ Max.
2	Shock	3 Times free drop from 75cm height to hard wooden board of thickness more than 30mm	Frequency Change: ±10ppm Max. Resistance Change: ±15% or 5kΩ Max.
3	Leakage	Put crystal units into a hermetic container and Helium for 0.5-0.6Mpa, and keep it for 1h; Check the leakage by a Helium leak detector	Leakage: 1x10 ⁻⁸ Pa·m ³ /s Max.

TYPE G4 SMD X'TAL

G43270021

VER. B 8-Nov-12

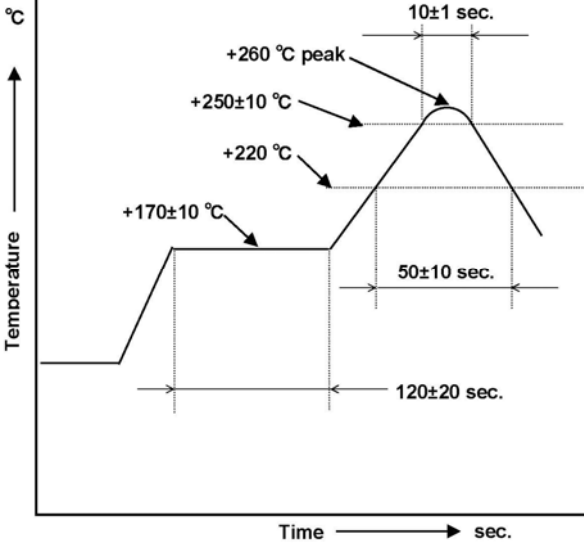
4	Reflow soldering	 <p>Note: the temperature used herein means the temperature on the circuit board. Reflow: 2 times max.</p>	<p>Frequency Change: ± 10ppm Max. Frequency Change: ± 10ppm Max. Resistance Change: $\pm 25\%$ or $10k\Omega$ Max.</p>
5	Lead Strength (DIP)	The crystal lead with the 0.9kg(9N) power (keep it for 30s \pm 5s) and bend the crystal lead 90° with 0.45kg power and two times	The crystal lead is not abnormality
6	High Temperature Endurance	The crystal units shall be put in somewhere for 2 hrs at temperature of $-85^{\circ}\text{C} \pm 2^{\circ}\text{C}$, then keep it for 1 to 2 hrs under room temperature.	Frequency Change: ± 10 ppm Max. Resistance Change: $\pm 15\%$ or $5k\Omega$ Max.
7	Low Temperature Endurance	The crystal units shall be put in somewhere for 2 hrs at temperature of -25°C , then keep it for 1 to 2 hrs under room temperature.	
8	Humidity Endurance	The crystal units shall be put in somewhere at 40°C in relative humidity of 90-95% for 48 hrs, then keep it for one or two hours under room temperature.	
9	Temperature Cycle	Temperature shift from low(-40°C) to high(100°C , keep 30 mins), satisfy high(100°C) to low(-40°C , keep 30 mins), then go up to room temperature for 5 cycles.	
10	Salt Spray Test	Put the crystal units in the salt spray room (salt density: 5%) at the temperature of 35°C for 96 hrs. Then clean it with water and dry its surface.	The appearance shall has no abnormality and soldering is good. Frequency Change: ± 10 ppm Max. Resistance Change: $\pm 15\%$ or $5k\Omega$ Max.

TYPE G4 SMD X'TAL

G43270021

VER. B 8-Nov-12

Marking

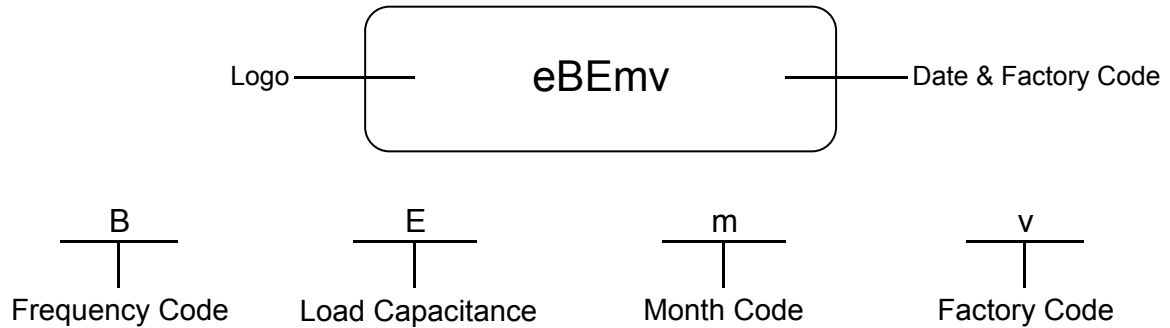

Dimensions (Units: mm)

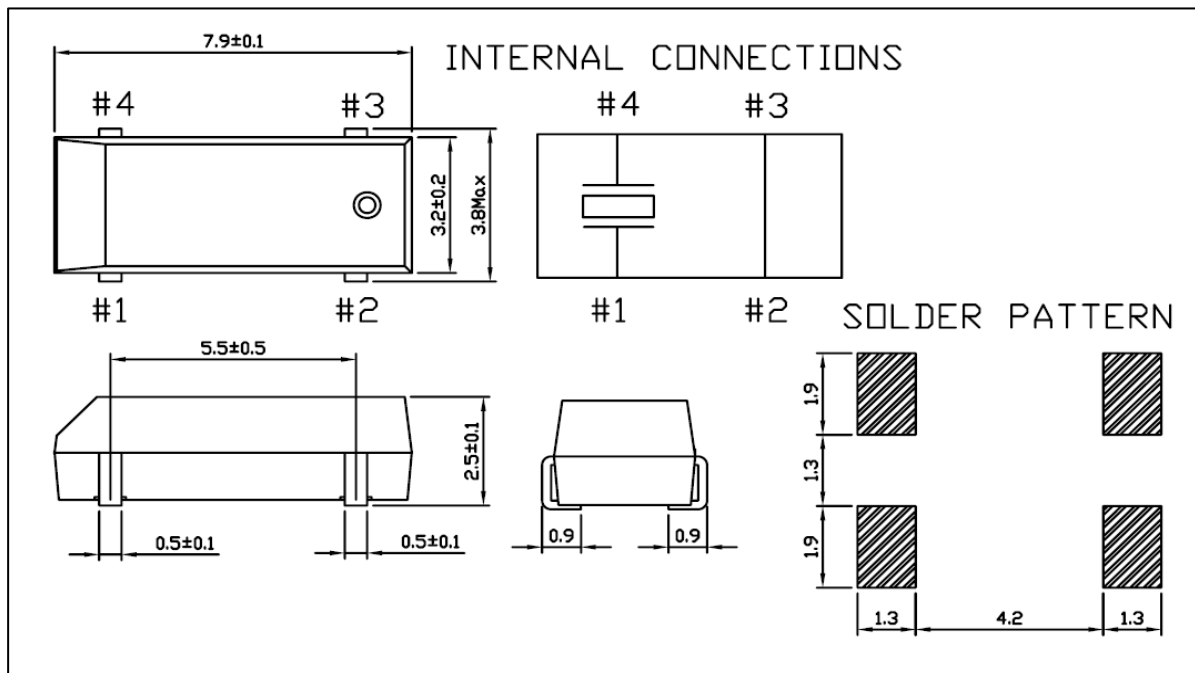

TYPE G4 SMD X'TAL

G43270021

VER. B 8-Nov-12

TAPE AND REEL SPECIFICATION

1. Tape and Reel form conform to EIA-481-B
2. The quantity of crystal units per reel shall be 3000PCS.
3. A "LABEL" on which necessary information is clearly written is on the surface of packing box and the reel.

CARRIER TAPE DIMENSIONS

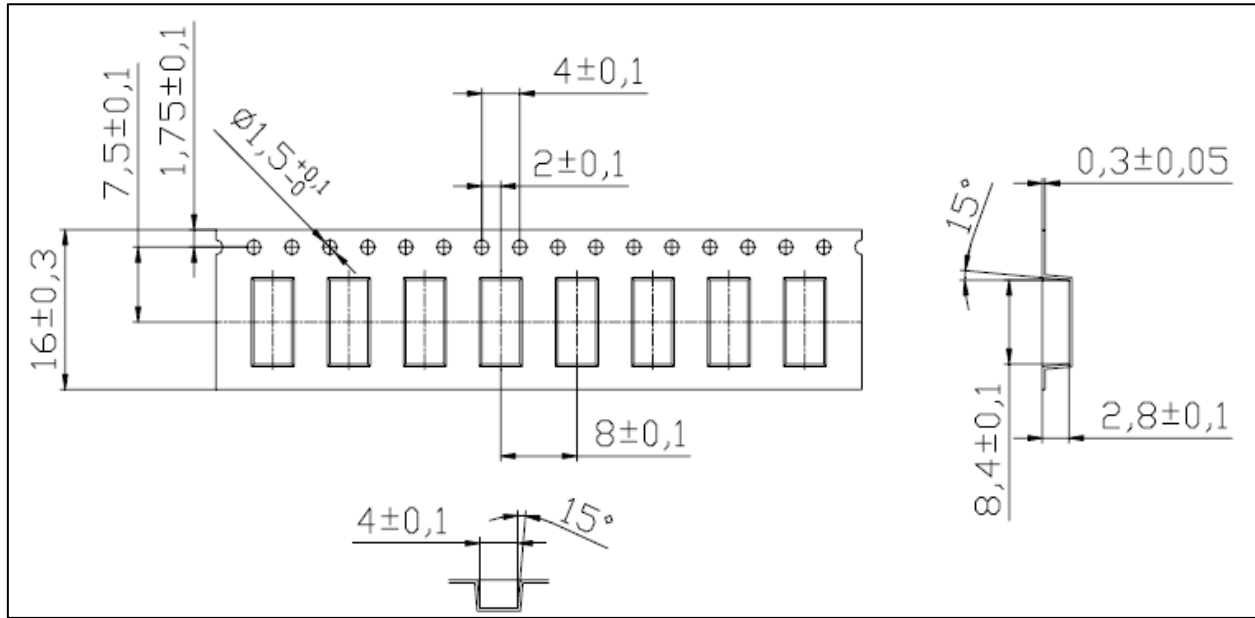

REEL DIMENSIONS

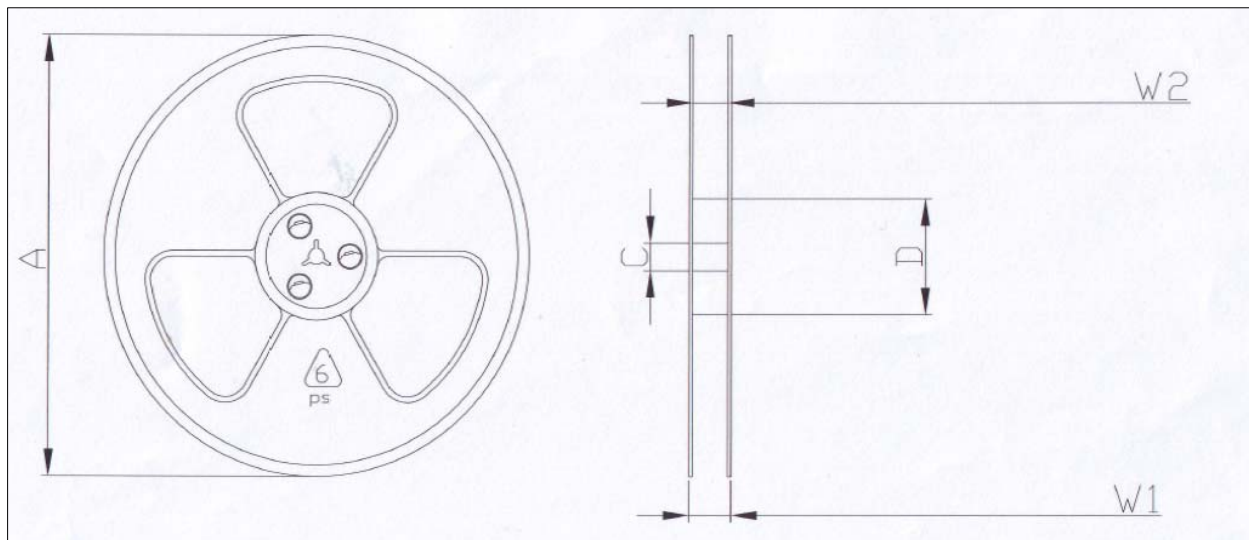

規格	A ± 0.5	C ± 0.2	D ± 0.3	W1 ± 0.2	W2 $^{+0.4}_{+0.2}$
330*100*16	330	25	100	20	16

X-ON Electronics

Largest Supplier of Electrical and Electronic Components

Click to view similar products for [Crystals](#) category:

Click to view products by [Diodes Incorporated](#) manufacturer:

Other Similar products are found below :

[MC405 32.0000K-R3:PURE SN](#) [7B-27.000MBBK-T](#) [MP1-8.0 99-BU](#) [9B-15.360MBBK-B](#) [PTX-A2JM-10.000M](#) [9C-7.680MBBK-T](#) [H10S-12.000-18-EXT-TR](#) [ABLS-18.432MHZ-20-D-4-T](#) [R38-32.768-12.5-5PPM-NPB](#) [BTD1062E05A-513](#) [21U15A-21.4MHZ](#) [RTX-781DF1-S-20.950](#) [LFXTAL066198Cutt](#) [9C-14.31818MBBK-T](#) [A-11.000MHZ-27](#) [ABM3B1-25.000MHZ-D2Y-T](#) [SPT2A-.032768B](#) [SPT2A.032768G](#) [SSPT7F-9PF20-R](#) [FX325BS-38.88EEM1201](#) [MP-1-25.000MHZ-3L](#) [MP-1-6.000MHZ](#) [LFXTAL065253Cutt](#) [LFXTAL066431Cutt](#) [XT9S20ANA14M7456](#) [XT9SNLANA16M](#) [646G-24-2](#) [7B-30.000MBBK-T](#) [9B-14.31818MBBK-B](#) [6504-202-1501](#) [6526-202-1501](#) [FA-118T](#) [27.1200MB50P-K0](#) [ABLS-12.000MHZ-B2Y-T](#) [BTJ120E02C](#) [SG636PCE-20.000MC](#) [3404](#) [CX3225SB48000Z0DZNC1](#) [CM315D32768EZFT](#) [C1E-24.000-7-2020-R](#) [C1E-19.200-12-1530-X-R](#) [C1E-16.000-12-1530-X-R](#) [FL5000014](#) [EUCA18-3.1872M](#) [425F35E027M0000](#) [FP0800018](#) [17196](#) [MS3V-T1R-32.768kHz-7pF-20PPM-TA-QC-Au](#) [VXM7-1C1-16M000](#) [MS1V-T1K-32.768kHz-10pF-20PPM-TA-QC-Au](#)