

# PSE Technology Corporation

## SPECIFICATION FOR APPROVAL

CUSTOMER	
NOMINAL FREQUENCY	<b>10.000000 MHz</b>
PRODUCT TYPE	<b>TYPE GB 49S QUARTZ CRYSTAL</b>
PART NUMBER	<b>GB1000015</b>
CUSTOMER P/N	
ISSUE DATE	<b>June 13, 2016</b>
VERSION	<b>A</b>

APPROVED	PREPARED	QA
<i>Brenda</i>	<i>Nikki Lu</i>	<i>Sung Yang</i>
APPROVED BY CUSTOMER		
Please return one copy with approval to PSE-TW		

### PSE Technology Corporation

No.2, Tzu-Chiang 5th Rd., Chung Li Industrial Park,  
 Chung Li City, Taoyuan County, Taiwan (R.O.C.)  
 TEL:886-3-451-8888  
 FAX:886-3-461-3865  
<http://www.saronix-ecera.com.tw/>

\*RoHS Compliant  
 \*HF-Halogen Free  
 \*REACH Compliant

**A Company of PERICOM Semiconductor Corporation**

# TYPE GB 49S QUARTZ CRYSTAL

## GB1000015

VER.A 13-JUN-16

### VERSION HISTORY

Version No.	Version Date	Customer Receipt Date	Supplier Receipt Date	Description	Notes
A	Jun. 13, 2016			Initial Release	

# TYPE GB 49S QUARTZ CRYSTAL

## GB1000015

VER.A 13-JUN-16

### ELECTRICAL SPECIFICATIONS

Item	Symbol	Specifications	Units	Notes
Nominal Frequency	Fn	10.000000	MHz	
Mode of Oscillation	MO	AT Cut-Fundamental		
Calibration Load Capacitance	CL	30	pF	
Calibration Tolerance	FL	± 30	ppm	at 25°C±3°C
Operating Temperature Range	TR	-20 to +70	°C	
Frequency Stability(Frequency Deviation over the Operating Temperature Range)	F/T	± 30	ppm	Reference to the Frequency at 25°C
Operating Drive Level		100	μW	
Equivalent Series Resistance	ESR	40	Ω	Max.
Shunt Capacitance	C0	5	pF	Max.
Aging at 25°C		± 3	ppm	Max, 1st year
Storage Temperature		-55 to +125	°C	
Insulation Resistance		500	MΩ	Min

# TYPE GB 49S QUARTZ CRYSTAL

**GB1000015**

VER.A 13-JUN-16

## RELIABILITY SPECIFICATIONS

### MECHANICAL AND ENVIRONMENTAL RATINGS:

- a) FINE LEAK TEST: JESD22-A109 (Condition 1A)
- b) GROSS LEAK TEST: JESD22-A109 (Condition C)
- c) MOISTURE RESISTANCE: JESD22-A113
- d) SHOCK: JESD22-B104 (Condition B)
- e) SOLDERABILITY : (RoHS version): J-STD-002
- f) VIBRATION: JESD22-B103
- g) SOLVENT RESISTANCE: JESD22-B107
- h) RESISTANCE TO SOLDERING HEAT (RoHS version): J-STD-020D Table 5.2 Pb free devices (3 cycles max)

## SUGGESTED IR REFLOW PROFILE

\*As per IPC-JEDEC J-STD-020D

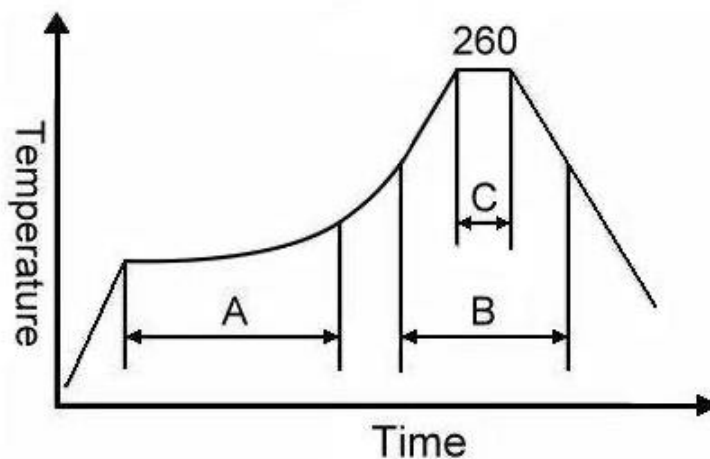

Note:

	Stage	Temperature	Time
A	Preheat	150~200°C	60~120 Sec
B	Primary Heat	217°C	60~150 Sec
C	Peak	260°C	10 Sec

For soldering reflow profile and reliability test ratings go to: <http://www.pericom.com/pdf/sre/reflow.pdf>

# TYPE GB 49S QUARTZ CRYSTAL

**GB1000015**

VER.A 13-JUN-16

## MARKING

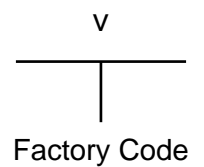
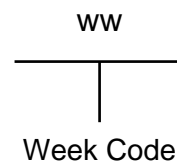
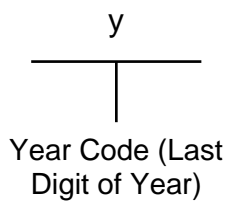
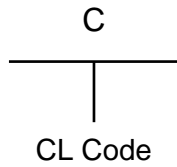
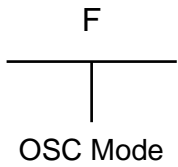
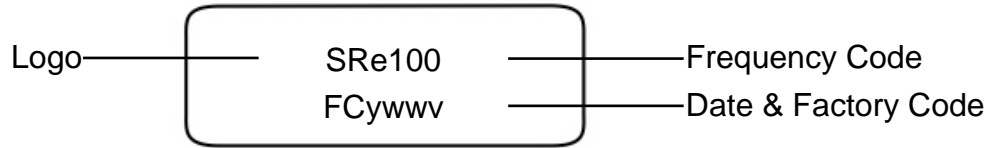

## MECHANICAL DRAWINGS ( Scale: None. Dimensions are in mm.)

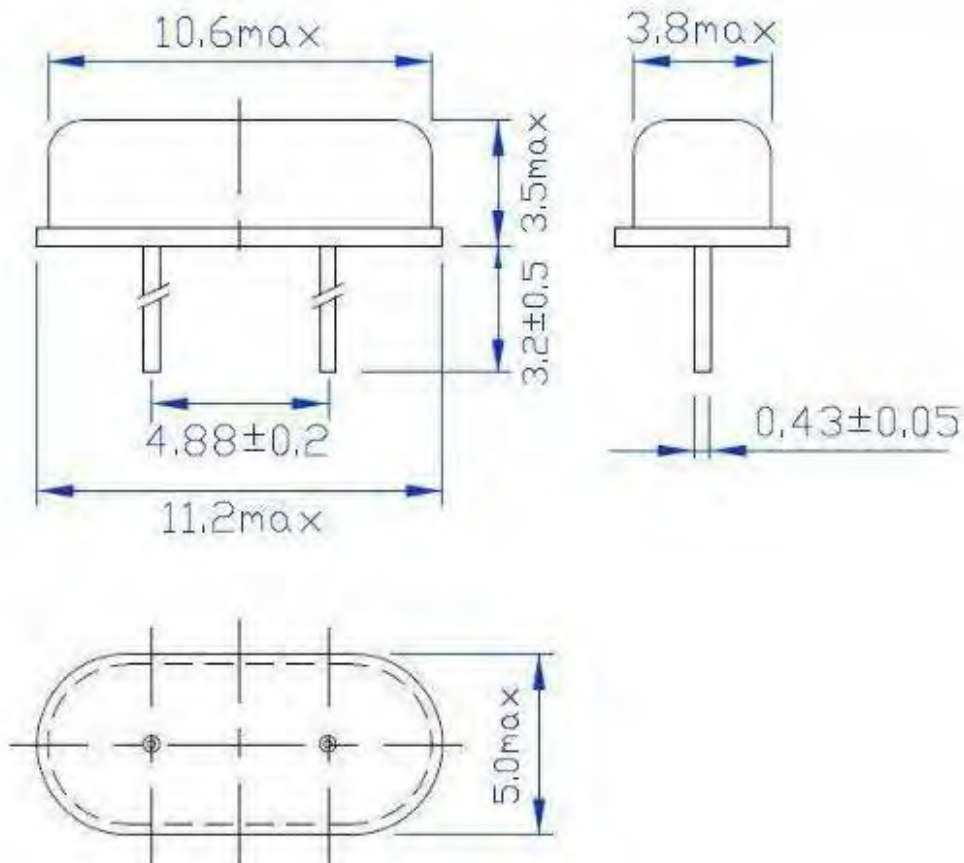

# TYPE GB 49S QUARTZ CRYSTAL

**GB1000015**

VER.A 13-JUN-16

## PACKING

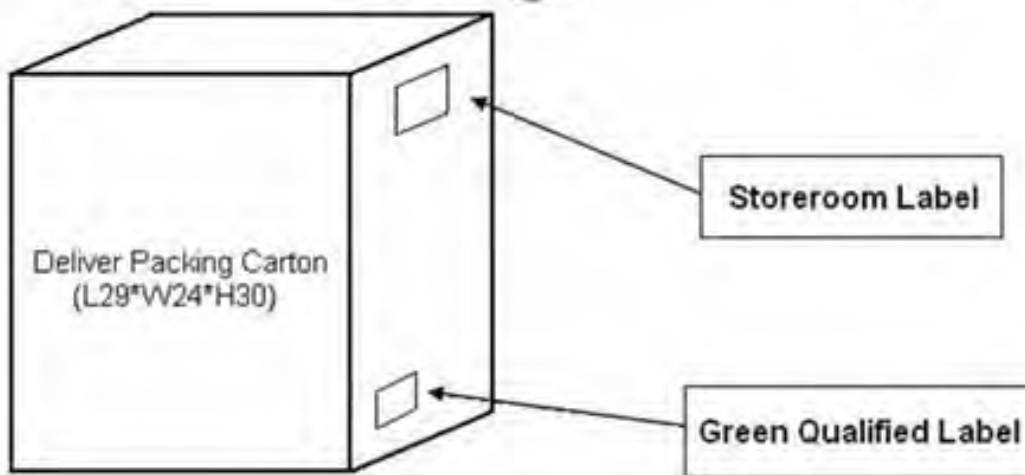
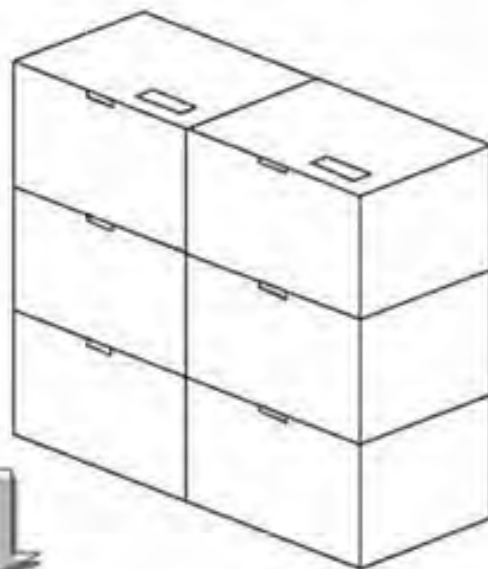
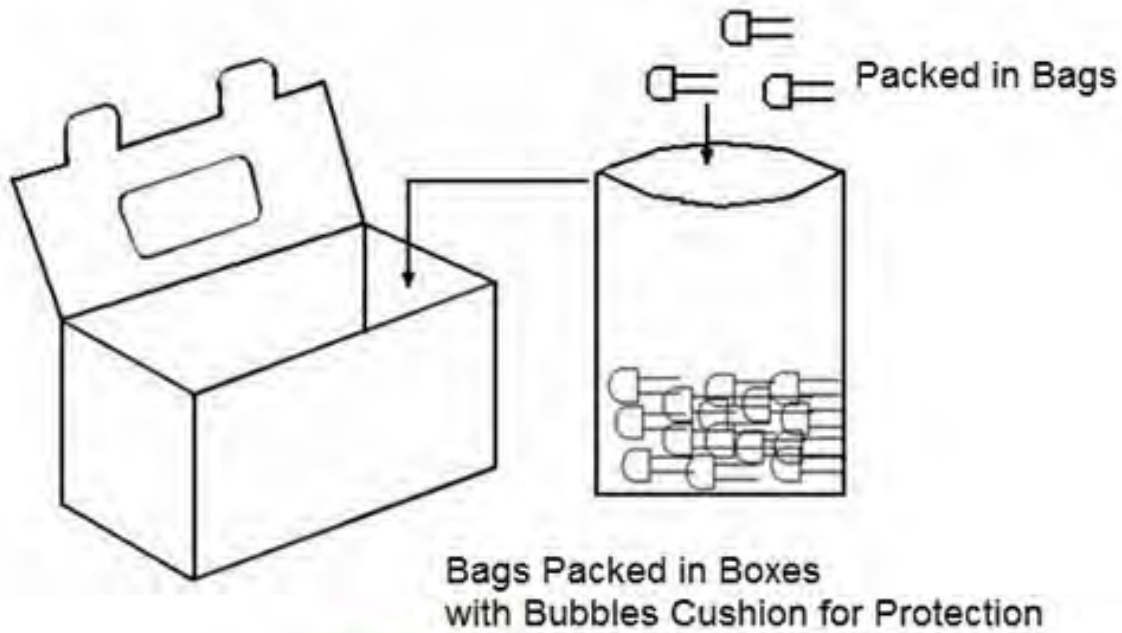

## X-ON Electronics

Largest Supplier of Electrical and Electronic Components

*Click to view similar products for [Crystals](#) category:*

*Click to view products by [Diodes Incorporated](#) manufacturer:*

Other Similar products are found below :

[MC405 32.0000K-R3:PURE SN](#) [7B-27.000MBBK-T](#) [MP1-8.0 99-BU](#) [9B-15.360MBBK-B](#) [PTX-A2JM-10.000M](#) [9C-7.680MBBK-T](#) [H10S-12.000-18-EXT-TR](#) [ABLS-18.432MHZ-20-D-4-T](#) [R38-32.768-12.5-5PPM-NPB](#) [BTD1062E05A-513](#) [21U15A-21.4MHZ](#) [RTX-781DF1-S-20.950](#) [LFXTAL066198Cutt](#) [9C-14.31818MBBK-T](#) [A-11.000MHZ-27](#) [ABM3B1-25.000MHZ-D2Y-T](#) [SPT2A-.032768B](#) [SPT2A.032768G](#) [SSPT7F-9PF20-R](#) [FX325BS-38.88EEM1201](#) [MP-1-25.000MHZ-3L](#) [MP-1-6.000MHZ](#) [LFXTAL065253Cutt](#) [LFXTAL066431Cutt](#) [XT9S20ANA14M7456](#) [XT9SNLANA16M](#) [646G-24-2](#) [7B-30.000MBBK-T](#) [9B-14.31818MBBK-B](#) [6504-202-1501](#) [6526-202-1501](#) [FA-118T](#) [27.1200MB50P-K0](#) [ABLS-12.000MHZ-B2Y-T](#) [BTJ120E02C](#) [SG636PCE-20.000MC](#) [3404](#) [CX3225SB48000Z0DZNC1](#) [CM315D32768EZFT](#) [C1E-24.000-7-2020-R](#) [C1E-19.200-12-1530-X-R](#) [C1E-16.000-12-1530-X-R](#) [FL5000014](#) [EUCA18-3.1872M](#) [425F35E027M0000](#) [FP0800018](#) [17196](#) [MS3V-T1R-32.768kHz-7pF-20PPM-TA-QC-Au](#) [VXM7-1C1-16M000](#) [MS1V-T1K-32.768kHz-10pF-20PPM-TA-QC-Au](#)