

Features

- Fast Switching Speed
- Ultra-Small Surface Mount Package
- For General Purpose Switching Applications
- High Conductance
- **Lead, Halogen and Antimony Free, RoHS Compliant "Green" Device (Notes 3, 4 and 5)**
- **Qualified to AEC-Q101 Standards for High Reliability**

Mechanical Data

- Case: SOT-323
- Case Material: Molded Plastic, "Green" Molding Compound, Note 5. UL Flammability Classification Rating 94V-0
- Moisture Sensitivity: Level 1 per J-STD-020D
- Terminals: Solderable per MIL-STD-202, Method 208
- Lead Free Plating (Matte Tin Finish annealed over Alloy 42 leadframe).
- Polarity: See Diagram
- Marking Information: See Page 2
- Ordering Information: See Page 2
- Weight: 0.006 grams (approximate)



SOT-323

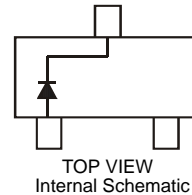

Maximum Ratings @ $T_A = 25^\circ\text{C}$ unless otherwise specified

Characteristic	Symbol	Value	Unit	
Non-Repetitive Peak Reverse Voltage	V_{RM}	100	V	
Peak Repetitive Reverse Voltage	V_{RRM}	75	V	
Working Peak Reverse Voltage	V_{RWM}			
DC Blocking Voltage	V_R			
RMS Reverse Voltage	$V_{R(RMS)}$	53	V	
Forward Continuous Current (Note 1)	I_{FM}	300	mA	
Average Rectified Output Current (Note 1)	I_O	150	mA	
Non-Repetitive Peak Forward Surge Current	I_{FSM}	@ $t = 1.0\mu\text{s}$	2.0	A
		@ $t = 1.0\text{s}$	1.0	

Thermal Characteristics

Characteristic	Symbol	Value	Unit
Power Dissipation (Note 1)	P_D	200	mW
Thermal Resistance Junction to Ambient Air (Note 1)	$R_{\theta JA}$	625	$^\circ\text{C/W}$
Operating and Storage Temperature Range	T_J, T_{STG}	-65 to +150	$^\circ\text{C}$

Electrical Characteristics @ $T_A = 25^\circ\text{C}$ unless otherwise specified

Characteristic	Symbol	Min	Max	Unit	Test Condition
Reverse Breakdown Voltage (Note 2)	$V_{(BR)R}$	75	—	V	$I_R = 1.0\mu\text{A}$
Forward Voltage	V_F	—	0.715 0.855 1.0 1.25	V	$I_F = 1.0\text{mA}$ $I_F = 10\text{mA}$ $I_F = 50\text{mA}$ $I_F = 150\text{mA}$
Reverse Current (Note 2)	I_R	—	1.0 50 30 25	μA μA μA nA	$V_R = 75\text{V}$ $V_R = 75\text{V}, T_J = 150^\circ\text{C}$ $V_R = 25\text{V}, T_J = 150^\circ\text{C}$ $V_R = 20\text{V}$
Total Capacitance	C_T	—	2.0	pF	$V_R = 0, f = 1.0\text{MHz}$
Reverse Recovery Time	t_{rr}	—	4.0	ns	$I_F = I_R = 10\text{mA}$, $I_{rr} = 0.1 \times I_R, R_L = 100\Omega$

- Notes:
1. Mounted on FR4 PC Board with recommended pad layout which can be found on our website at <http://www.diodes.com/datasheets/ap02001.pdf>.
 2. Short duration pulse test used to minimize self-heating effect.
 3. No purposefully added lead. Halogen and Antimony Free.
 4. Diodes Inc.'s "Green" policy can be found on our website at http://www.diodes.com/products/lead_free/index.php.
 5. Product manufactured with Green Molding Compound and does not contain Halogens or Sb_2O_3 Fire Retardants.

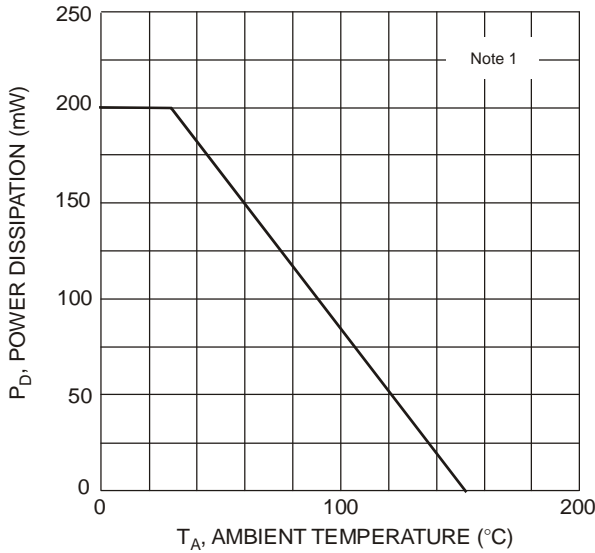

Fig. 1 Power Derating Curve

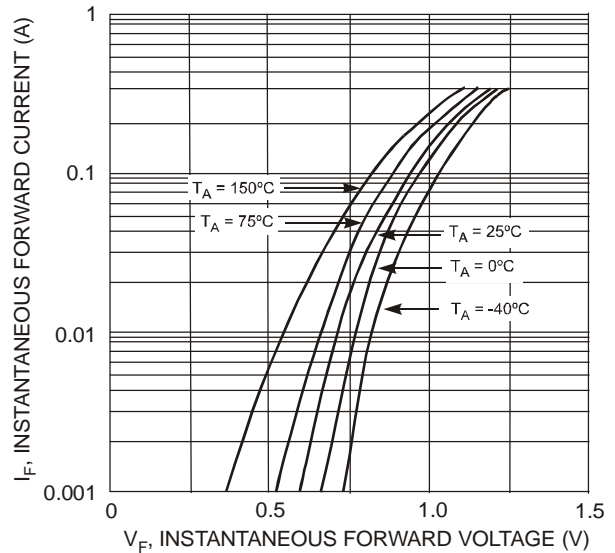

Fig. 2 Typical Forward Characteristics

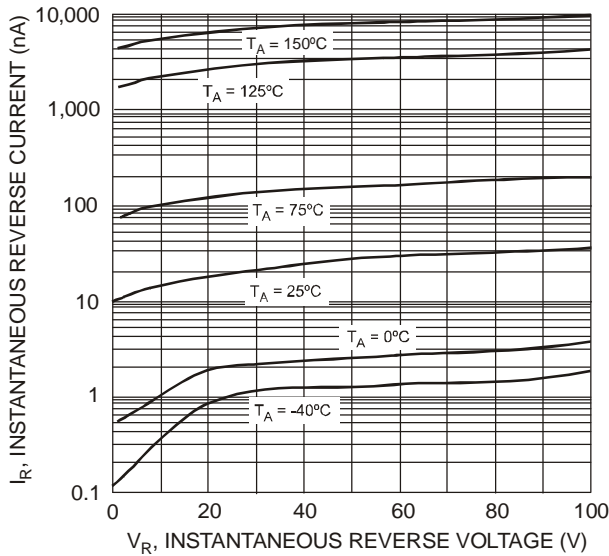

Fig. 3 Typical Reverse Characteristics

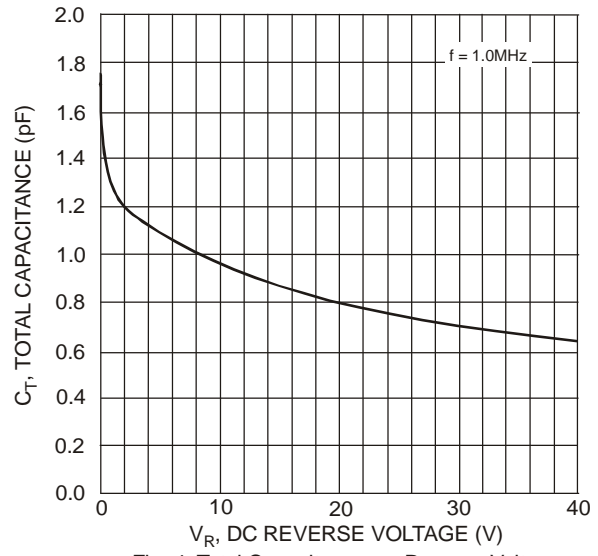

Fig. 4 Total Capacitance vs. Reverse Voltage

Ordering Information (Notes 5 & 6)

Device	Packaging	Shipping
MMBD4148W-7-F	SOT-323	3000/Tape & Reel
BAS16W-7-F	SOT-323	3000/Tape & Reel

Notes: 6. For packaging details, go to our website at <http://www.diodes.com/datasheets/ap02007.pdf>.

Marking Information

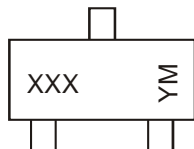

xxx = Product Type Marking Code (KA2, KT1)
 YM = Date Code Marking
 Y = Year ex: N = 2002
 M = Month ex: 9 = September

Date Code Key

Year	2000	2001	2002	2003	2004	2005	2006	2007	2008	2009	2010	2011	2012
Code	L	M	N	P	R	S	T	U	V	W	X	Y	Z

Month	Jan	Feb	Mar	Apr	May	Jun	Jul	Aug	Sep	Oct	Nov	Dec
Code	1	2	3	4	5	6	7	8	9	O	N	D

Package Outline Dimensions

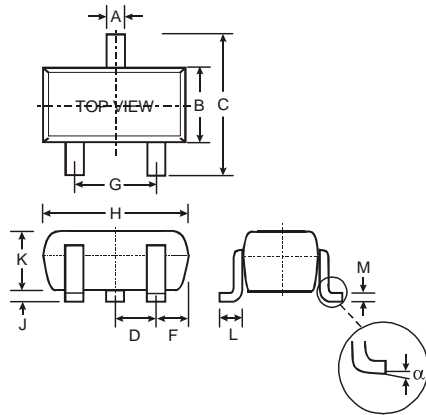

SOT-323		
Dim	Min	Max
A	0.25	0.40
B	1.15	1.35
C	2.00	2.20
D	0.65 Nominal	
F	0.30	0.40
G	1.20	1.40
H	1.80	2.20
J	0.0	0.10
K	0.90	1.00
L	0.25	0.40
M	0.10	0.18
α	0°	8°
All Dimensions in mm		

Suggested Pad Layout

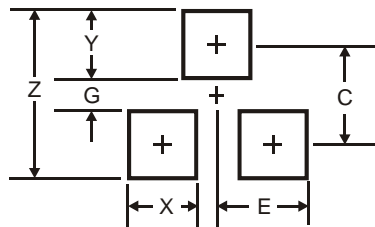

Dimensions	Value (in mm)
Z	2.8
G	1.0
X	0.7
Y	0.9
C	1.9
E	0.65

IMPORTANT NOTICE

Diodes Incorporated and its subsidiaries reserve the right to make modifications, enhancements, improvements, corrections or other changes without further notice to any product herein. Diodes Incorporated does not assume any liability arising out of the application or use of any product described herein; neither does it convey any license under its patent rights, nor the rights of others. The user of products in such applications shall assume all risks of such use and will agree to hold Diodes Incorporated and all the companies whose products are represented on our website, harmless against all damages.

LIFE SUPPORT

Diodes Incorporated products are not authorized for use as critical components in life support devices or systems without the expressed written approval of the President of Diodes Incorporated.

X-ON Electronics

Largest Supplier of Electrical and Electronic Components

Click to view similar products for [Diodes - General Purpose, Power, Switching category:](#)

Click to view products by [Diodes Incorporated manufacturer:](#)

Other Similar products are found below :

[RD0306T-H](#) [BAQ33-GS18](#) [BAV17-TR](#) [BAV19-TR](#) [NTE525](#) [1SS181-TP](#) [1SS193,LF](#) [1SS400CST2RA](#) [SDAA13](#) [SHN2D02FUTW1T1G](#)
[LS4151GS08](#) [1N4449](#) [1N456A](#) [1N4934-E3/73](#) [1N914B](#) [1N914BTR](#) [RFUH20TB3S](#) [BAS 28 E6327](#) [BAV199-TP](#) [BAW56DWQ-7-F](#)
[BAW75-TAP](#) [MM230L-CAA](#) [IDW40E65D1](#) [LL4151-GS18](#) [053684A](#) [SMMSD4148T3G](#) [707803H](#) [SP000010217](#) [ACDSW4448-HF](#)
[CDSZC01100-HF](#) [BAV199E6433HTMA1](#) [BAV70M3T5G](#) [SMBT2001T1G](#) [DLM10C-AT1](#) [BAS28-7](#) [BAW56HDW-13](#) [BAS28 TR](#) [VS-](#)
[HFA04SD60STR-M3](#) [NSVM1MA152WKT1G](#) [BAV99TQ-13-F](#) [BAS21DWA-7](#) [P600K](#) [D75-1100-24](#) [MMDB30-E28X](#) [VS-HFA04SD60SL-](#)
[M3](#) [LS4148](#) [IDV15E65D2](#) [NSVM1MA152WAT1G](#) [JANTXV1N4454-1](#) [S5AC](#)