

Features

- Epitaxial Planar Die Construction
- Low Saturation Voltage $V_{CE(sat)} < 300\text{mV}$ @ 150mA
- Complementary PNP Type: MMBT2907A
- Ideal for Low Power Amplification and Switching
- **Totally Lead-Free & Fully RoHS Compliant (Notes 1 & 2)**
- **Halogen- and Antimony-Free. "Green" Device (Note 3)**
- **The MMBT2222AQ-7-F is suitable for automotive applications requiring specific change control; this part is AEC-Q101 qualified, PPAP capable, and manufactured in IATF 16949 certified facilities.**

<https://www.diodes.com/quality/product-definitions/>

Mechanical Data

- Case: SOT23
- Case Material: Molded Plastic, "Green" Molding Compound; UL Flammability Classification Rating 94V-0
- Moisture Sensitivity: Level 1 per J-STD-020
- Terminals: Matte Tin Finish; Solderable per MIL-STD-202, Method 208 @3
- Weight: 0.008 grams (Approximate)

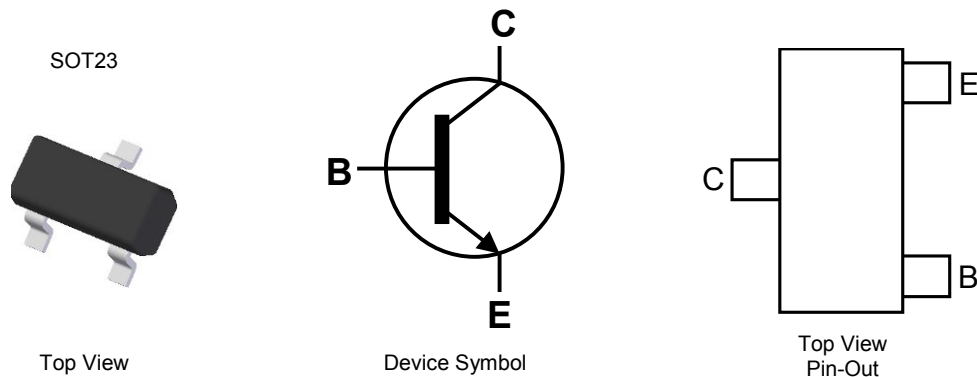

Ordering Information (Note 4)

Product	Compliance	Marking	Reel Size (inches)	Tape Width (mm)	Quantity per Reel
MMBT2222A-7-F	Standard	K1P	7	8	3,000
MMBT2222A-13-F	Standard	K1P	13	8	10,000
MMBT2222AQ-7-F	Automotive	K1P	7	8	3,000

- Notes:
1. No purposely added lead. Fully EU Directive 2002/95/EC (RoHS), 2011/65/EU (RoHS 2) & 2015/863/EU (RoHS 3) compliant.
 2. See <https://www.diodes.com/quality/lead-free/> for more information about Diodes Incorporated's definitions of Halogen- and Antimony-free, "Green" and Lead-free.
 3. Halogen and Antimony free "Green" products are defined as those which contain <900ppm bromine, <900ppm chlorine (<1500ppm total Br + Cl) and <1000ppm antimony compounds.
 4. For packaging details, go to our website at <https://www.diodes.com/design/support/packaging/diodes-packaging/>.

Marking Information

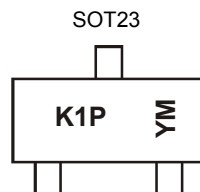

K1P = Product Type Marking Code
 YM = Date Code Marking
 Y or \bar{Y} = Year (ex: H = 2020)
 M or \bar{M} = Month (ex: 9 = September)

Date Code Key

Year	2020	2021	2022	2023	2024	2025	2026	2027	2028	2029
Code	H	I	J	K	L	M	N	O	P	R

Month	Jan	Feb	Mar	Apr	May	Jun	Jul	Aug	Sep	Oct	Nov	Dec
Code	1	2	3	4	5	6	7	8	9	O	N	D

Absolute Maximum Ratings (@ $T_A = +25^\circ\text{C}$, unless otherwise specified.)

Characteristic	Symbol	Value	Unit
Collector-Base Voltage	V_{CBO}	75	V
Collector-Emitter Voltage	V_{CEO}	40	V
Emitter-Base Voltage	V_{EBO}	6.0	V
Collector Current	I_C	600	mA
Peak Pulse Collector Current (single pulse)	I_{CM}	800	mA
Peak Pulse Base Current	I_{BM}	200	mA

Thermal Characteristics (@ $T_A = +25^\circ\text{C}$, unless otherwise specified.)

Characteristic	Symbol	Value	Unit
Collector Power Dissipation	P_D	(Note 5)	310
		(Note 6)	350
Thermal Resistance, Junction to Ambient	$R_{\theta JA}$	(Note 5)	403
		(Note 6)	357
Thermal Resistance, Junction to Leads	$R_{\theta JL}$	350	$^\circ\text{C/W}$
Operating and Storage Temperature Range	T_J, T_{STG}	-55 to +150	$^\circ\text{C}$

ESD Ratings (Note 8)

Characteristic	Symbol	Value	Unit	JEDEC Class
Electrostatic Discharge - Human Body Model	ESD HBM	4,000	V	3A
Electrostatic Discharge - Machine Model	ESD MM	400	V	C

- Notes:
5. For a device mounted on minimum recommended pad layout 1oz copper that is on a single-sided FR-4 PCB; device is measured under still air conditions whilst operating in a steady-state.
 6. Same as Note 5, except the device is mounted on 15 mm x 15mm 1oz copper.
 7. Thermal resistance from junction to solder-point (at the end of the leads).
 8. Refer to JEDEC specification JESD22-A114 and JESD22-A115.

Thermal Characteristics and Derating Information

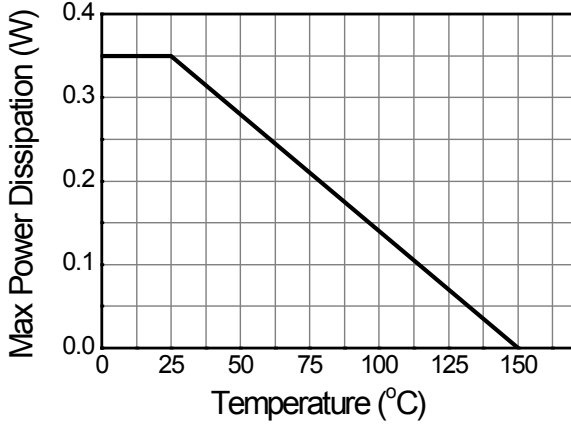

Derating Curve

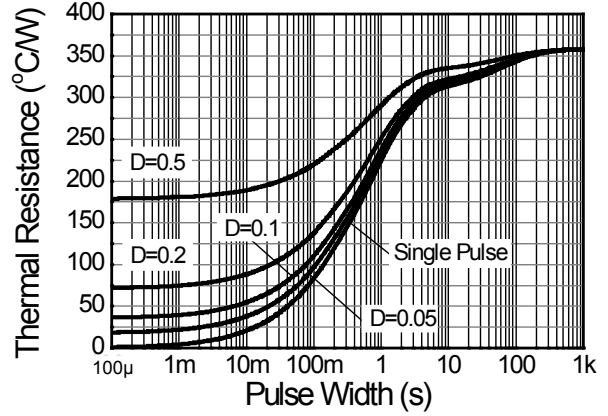

Transient Thermal Impedance

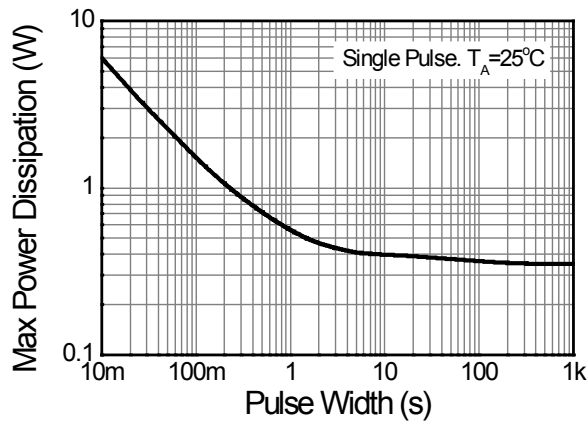

Pulse Power Dissipation

Electrical Characteristics (@ $T_A = +25^\circ\text{C}$, unless otherwise specified.)

Characteristic	Symbol	Min	Max	Unit	Test Condition
OFF CHARACTERISTICS					
Collector-Base Breakdown Voltage	BV_{CBO}	75	—	V	$I_C = 100\mu\text{A}$, $I_E = 0$
Collector-Emitter Breakdown Voltage (Note 9)	BV_{CEO}	40	—	V	$I_C = 10\text{mA}$, $I_B = 0$
Emitter-Base Breakdown Voltage	BV_{EBO}	6.0	—	V	$I_E = 100\mu\text{A}$, $I_C = 0$
Collector Cut-Off Current	I_{CBO}	—	10	nA μA	$V_{CB} = 60\text{V}$, $I_E = 0$ $V_{CB} = 60\text{V}$, $I_E = 0$, $T_A = +150^\circ\text{C}$
Collector Cut-Off Current	I_{CEX}	—	10	nA	$V_{CE} = 60\text{V}$, $V_{EB(\text{off})} = 3.0\text{V}$
Collector Cut-Off Current	I_{CEV}	—	10	nA	$V_{CE} = 60\text{V}$, $V_{BE} = \pm 0.25\text{V}$
Emitter Cut-Off Current	I_{EBO}	—	10	nA	$V_{EB} = 5.0\text{V}$, $I_C = 0$
Base Cut-Off Current	I_{BL}	—	20	nA	$V_{CE} = 60\text{V}$, $V_{EB(\text{off})} = 3.0\text{V}$
ON CHARACTERISTICS (Note 9)					
DC Current Gain	h_{FE}	35 50 75 100 40 50 35	— — — 300 — — —	—	$I_C = 100\mu\text{A}$, $V_{CE} = 10\text{V}$ $I_C = 1.0\text{mA}$, $V_{CE} = 10\text{V}$ $I_C = 10\text{mA}$, $V_{CE} = 10\text{V}$ $I_C = 150\text{mA}$, $V_{CE} = 10\text{V}$ $I_C = 500\text{mA}$, $V_{CE} = 10\text{V}$ $I_C = 10\text{mA}$, $V_{CE} = 10\text{V}$, $T_A = -55^\circ\text{C}$ $I_C = 150\text{mA}$, $V_{CE} = 1.0\text{V}$
Collector-Emitter Saturation Voltage	$V_{CE(\text{sat})}$	—	0.3 1.0	V	$I_C = 150\text{mA}$, $I_B = 15\text{mA}$ $I_C = 500\text{mA}$, $I_B = 50\text{mA}$
Base-Emitter Saturation Voltage	$V_{BE(\text{sat})}$	0.6 —	1.2 2.0	V	$I_C = 150\text{mA}$, $I_B = 15\text{mA}$ $I_C = 500\text{mA}$, $I_B = 50\text{mA}$
SMALL SIGNAL CHARACTERISTICS					
Output Capacitance	C_{obo}	—	8	pF	$V_{CB} = 10\text{V}$, $f = 1.0\text{MHz}$, $I_E = 0$
Input Capacitance	C_{ibo}	—	25	pF	$V_{EB} = 0.5\text{V}$, $f = 1.0\text{MHz}$, $I_C = 0$
Transition frequency	f_T	300	—	MHz	$V_{CE} = 20\text{V}$, $I_C = 20\text{mA}$, $f = 100\text{MHz}$
Noise Figure	N_F	—	4.0	dB	$V_{CE} = 10\text{V}$, $I_C = 100\mu\text{A}$, $R_S = 1.0\text{k}\Omega$, $f = 1.0\text{kHz}$
SWITCHING CHARACTERISTICS					
Delay Time	t_d	—	10	ns	$V_{CC} = 30\text{V}$, $I_C = 150\text{mA}$, $V_{BE(\text{off})} = -0.5\text{V}$, $I_{B1} = 15\text{mA}$
Rise Time	t_r	—	25	ns	$V_{CC} = 30\text{V}$, $I_C = 150\text{mA}$, $I_{B1} = 15\text{mA}$, $V_{BE(\text{off})} = 0.5\text{V}$
Storage Time	t_s	—	225	ns	$V_{CC} = 30\text{V}$, $I_C = 150\text{mA}$, $I_{B1} = -I_{B2} = 15\text{mA}$
Fall Time	t_f	—	60	ns	$V_{CC} = 30\text{V}$, $I_C = 150\text{mA}$, $I_{B1} = -I_{B2} = 15\text{mA}$

Note: 9. Measured under pulsed conditions. Pulse width $\leq 300\mu\text{s}$. Duty cycle $\leq 2\%$.

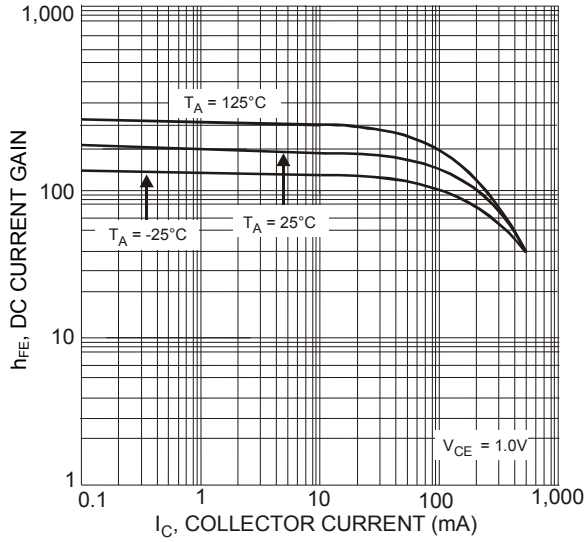

$h_{FE} \ v \ I_C$

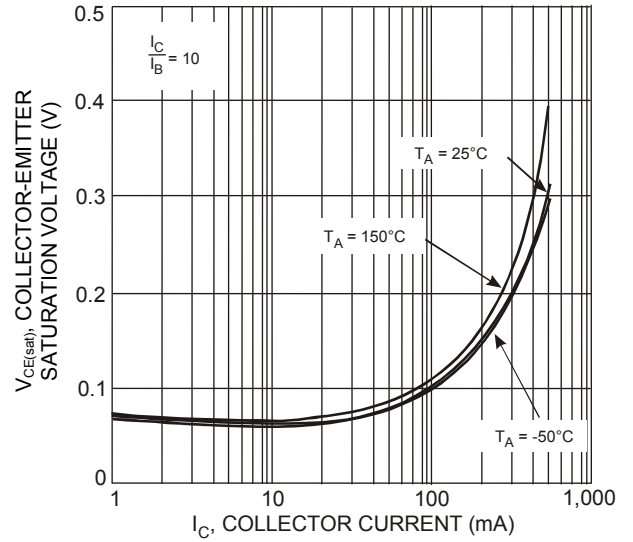

$V_{CE(sat)} \ v \ I_C$

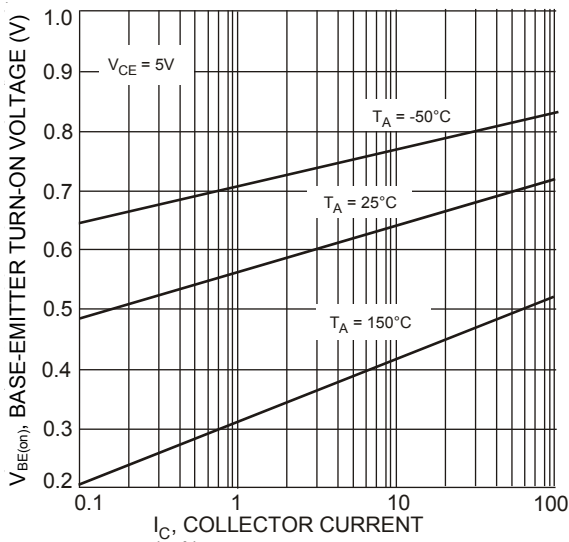

$V_{BE(on)} \ v \ I_C$

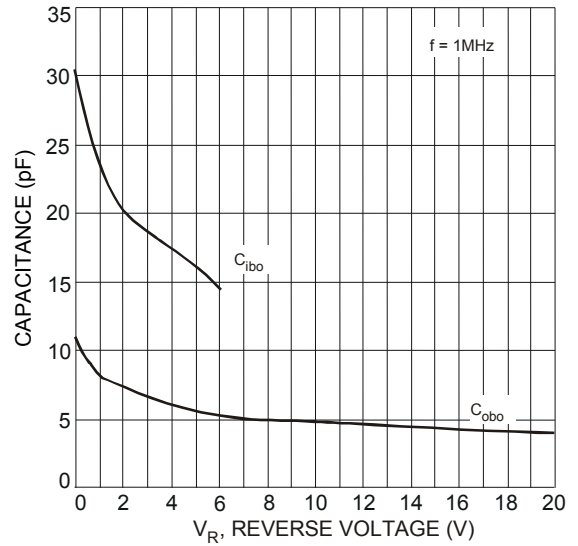

$C \ v \ V_R$

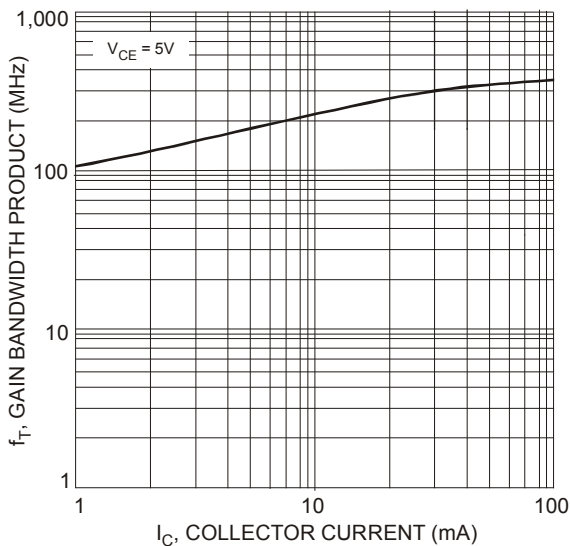

$f_T \ v \ I_C$

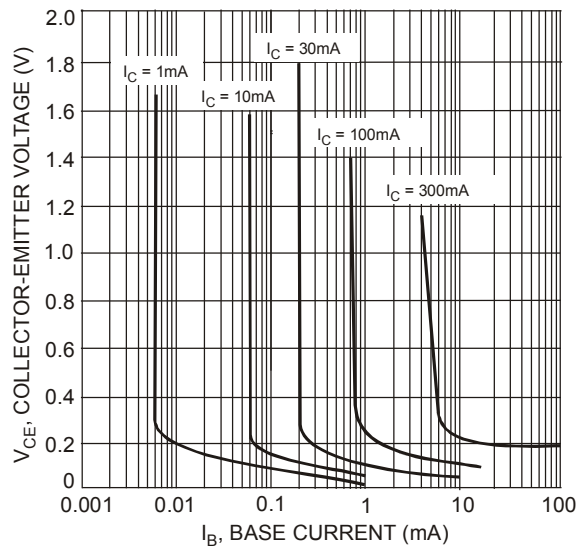

$V_{CE} \ v \ I_B$

Package Outline Dimensions

Please see <http://www.diodes.com/package-outlines.html> for the latest version.

SOT23

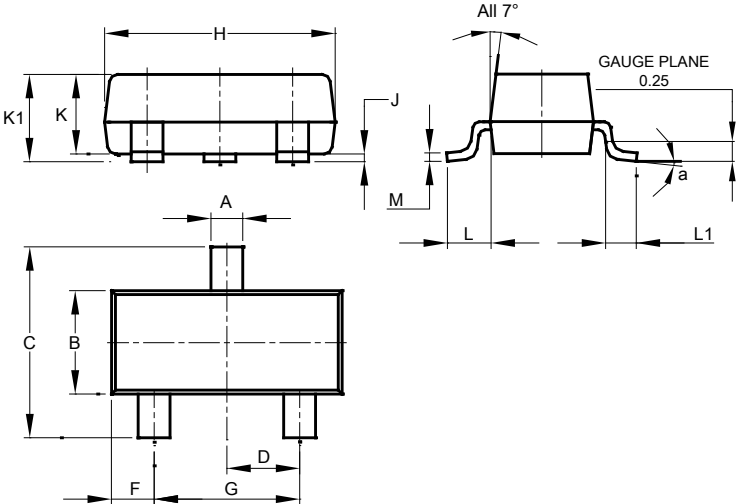

SOT23			
Dim	Min	Max	Typ
A	0.37	0.51	0.40
B	1.20	1.40	1.30
C	2.30	2.50	2.40
D	0.89	1.03	0.915
F	0.45	0.60	0.535
G	1.78	2.05	1.83
H	2.80	3.00	2.90
J	0.013	0.10	0.05
K	0.890	1.00	0.975
K1	0.903	1.10	1.025
L	0.45	0.61	0.55
L1	0.25	0.55	0.40
M	0.085	0.150	0.110
a	0°	8°	--
All Dimensions in mm			

Suggested Pad Layout

Please see <http://www.diodes.com/package-outlines.html> for the latest version.

SOT23

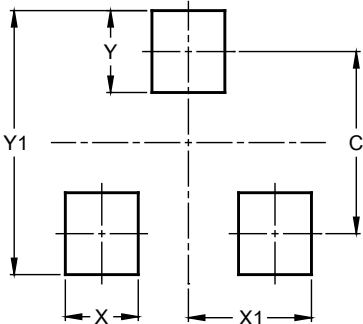

Dimensions	Value (in mm)
C	2.0
X	0.8
X1	1.35
Y	0.9
Y1	2.9

IMPORTANT NOTICE

1. DIODES INCORPORATED AND ITS SUBSIDIARIES (“DIODES”) MAKE NO WARRANTY OF ANY KIND, EXPRESS OR IMPLIED, WITH REGARDS TO ANY INFORMATION CONTAINED IN THIS DOCUMENT, INCLUDING, BUT NOT LIMITED TO, THE IMPLIED WARRANTIES OF MERCHANTABILITY, FITNESS FOR A PARTICULAR PURPOSE OR NON-INFRINGEMENT OF THIRD PARTY INTELLECTUAL PROPERTY RIGHTS (AND THEIR EQUIVALENTS UNDER THE LAWS OF ANY JURISDICTION).
2. The Information contained herein is for informational purpose only and is provided only to illustrate the operation of Diodes products described herein and application examples. Diodes does not assume any liability arising out of the application or use of this document or any product described herein. This document is intended for skilled and technically trained engineering customers and users who design with Diodes products. Diodes products may be used to facilitate safety-related applications; however, in all instances customers and users are responsible for (a) selecting the appropriate Diodes products for their applications, (b) evaluating the suitability of the Diodes products for their intended applications, (c) ensuring their applications, which incorporate Diodes products, comply the applicable legal and regulatory requirements as well as safety and functional-safety related standards, and (d) ensuring they design with appropriate safeguards (including testing, validation, quality control techniques, redundancy, malfunction prevention, and appropriate treatment for aging degradation) to minimize the risks associated with their applications.
3. Diodes assumes no liability for any application-related information, support, assistance or feedback that may be provided by Diodes from time to time. Any customer or user of this document or products described herein will assume all risks and liabilities associated with such use, and will hold Diodes and all companies whose products are represented herein or on Diodes’ websites, harmless against all damages and liabilities.
4. Products described herein may be covered by one or more United States, international or foreign patents and pending patent applications. Product names and markings noted herein may also be covered by one or more United States, international or foreign trademarks and trademark applications. Diodes does not convey any license under any of its intellectual property rights or the rights of any third parties (including third parties whose products and services may be described in this document or on Diodes’ website) under this document.
5. Diodes products are provided subject to Diodes’ Standard Terms and Conditions of Sale (<https://www.diodes.com/about/company/terms-and-conditions/terms-and-conditions-of-sales/>) or other applicable terms. This document does not alter or expand the applicable warranties provided by Diodes. Diodes does not warrant or accept any liability whatsoever in respect of any products purchased through unauthorized sales channel.
6. Diodes products and technology may not be used for or incorporated into any products or systems whose manufacture, use or sale is prohibited under any applicable laws and regulations. Should customers or users use Diodes products in contravention of any applicable laws or regulations, or for any unintended or unauthorized application, customers and users will (a) be solely responsible for any damages, losses or penalties arising in connection therewith or as a result thereof, and (b) indemnify and hold Diodes and its representatives and agents harmless against any and all claims, damages, expenses, and attorney fees arising out of, directly or indirectly, any claim relating to any noncompliance with the applicable laws and regulations, as well as any unintended or unauthorized application.
7. While efforts have been made to ensure the information contained in this document is accurate, complete and current, it may contain technical inaccuracies, omissions and typographical errors. Diodes does not warrant that information contained in this document is error-free and Diodes is under no obligation to update or otherwise correct this information. Notwithstanding the foregoing, Diodes reserves the right to make modifications, enhancements, improvements, corrections or other changes without further notice to this document and any product described herein. This document is written in English but may be translated into multiple languages for reference. Only the English version of this document is the final and determinative format released by Diodes.
8. Any unauthorized copying, modification, distribution, transmission, display or other use of this document (or any portion hereof) is prohibited. Diodes assumes no responsibility for any losses incurred by the customers or users or any third parties arising from any such unauthorized use.

Copyright © 2021 Diodes Incorporated

www.diodes.com

X-ON Electronics

Largest Supplier of Electrical and Electronic Components

Click to view similar products for [Bipolar Transistors - BJT category](#):

Click to view products by [Diodes Incorporated manufacturer](#):

Other Similar products are found below :

[619691C](#) [MCH4017-TL-H](#) [BC546/116](#) [BC557/116](#) [BSW67A](#) [NTE187A](#) [NTE195A](#) [NTE2302](#) [NTE2330](#) [NTE63](#) [C4460](#) [2SA1419T-TD-H](#)
[2SA1721-O\(TE85L,F\)](#) [2SA2126-E](#) [2SB1204S-TL-E](#) [2SC5488A-TL-H](#) [2SD2150T100R](#) [SP000011176](#) [2N2369ADCSM](#) [2SC2412KT146S](#)
[2SC5490A-TL-H](#) [2SD1816S-TL-E](#) [2SD1816T-TL-E](#) [CMXT2207 TR](#) [CPH6501-TL-E](#) [MCH4021-TL-E](#) [US6T6TR](#) [732314D](#) [CMXT3906 TR](#)
[CPH3121-TL-E](#) [CPH6021-TL-H](#) [873787E](#) [UMX21NTR](#) [EMT2T2R](#) [MCH6102-TL-E](#) [FP204-TL-E](#) [NJL0302DG](#) [2N3583](#) [2N3879](#)
[2SA1434-TB-E](#) [2SC3143-4-TB-E](#) [2SD1621S-TD-E](#) [30A02MH-TL-E](#) [NSV40301MZ4T1G](#) [NTE13](#) [NTE15](#) [NTE16001](#) [NTE16006](#) [NTE26](#)
[NTE320](#)