

PSE Technology Corporation

SPECIFICATION FOR APPROVAL

CUSTOMER _____

NOMINAL FREQUENCY 156.250000 MHz

PRODUCT TYPE TYPE NX 7.0x5.0 SEAM SEALED CRYSTAL CLOCK OSCILLATOR

SPEC. NO. (P/N) NX72F6208Z

CUSTOMER P/N _____

ISSUE DATE February 26, 2015

VERSION A

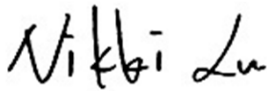
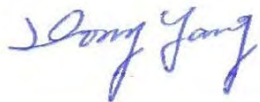
APPROVED	PREPARED	QA
		
APPROVED BY CUSTOMER :		AVL Status
Please return one copy with approval to PSE-TW		

PSE Technology Corporation

No.2, Tzu-Chiang 5th Rd, Chung Li Industrial Park,
 Chung Li City, Taoyuan County, Taiwan (R.O.C.)
 TEL: 886-3-451-8888
 FAX: 886-3-461-3865
<http://www.saronix-ecera.com.tw>

- *Pb-free
- *RoHS Compliant
- *HF-Halogen Free
- *REACH Compliant

*** A company of  PERICOM Semiconductor Corporation ***

TYPE NX 7.0x5.0 SEAM SEALED CRYSTAL CLOCK OSCILLATOR

NX72F6208Z

VER. A 26-Feb-15

ELECTRICAL SPECIFICATIONS

SRe Part Number : NX72F6208Z

Item	Symbol	Specifications	Units	Notes
Nominal Frequency	F _o	156.250000	MHz	
Frequency Stability	FT	± 50	ppm	**See note
Operating Temperature Range	TR	-20 to +70	°C	
Supply Voltage	V _{CC}	+3.3 ± 5.0%	V	
Logic Type	LT	LVPECL		
Supply Current, Output Enabled	I _{CC/OE}	80	mA	Max.
Supply Current, Output Disabled	I _{CC/OD}	40	mA	Max.
Duty Cycle (Symmetry)	DC/SY	45 / 55	%	Measured 50% of Waveform
Rise / Fall Time	T _R /T _F	400	ps	Max. measured 20/80% of Waveform
Output Voltage "0" Level	V _{OL}	V _{CC} -1.55V	V	Max.
Output Voltage "1" Level	V _{OH}	V _{CC} -1.2V	V	Min.
Output Load		50Ω to V _{CC} -2V		
Jitter, Phase	RMS	0.6	ps	Max. 12KHz ~ 20MHz Frequency Band
Jitter, Phase	RMS	2.8	ps	Max. 10Hz ~ 1MHz Frequency Band
Jitter, Accumulated	RMS(1-σ)	6	ps	Max. 20,000 Consecutive Periods
Jitter, Peak to Peak	PK-PK	40	ps	Max. 100,000 Random Periods
Storage Temperature Range		-55 to +125	°C	

※ This product doesn't include harmful substance that stipulated by SONY SS-00259 Level 1 and S-AT2-001 Level 1 standard. RoHS Compliant (Pb - Free).

**Stability includes all combinations of Operating Temperature, Load changes, rated Input (Supply) Voltage changes, Initial Calibration Tolerance (25°C), Aging (1 year at 25°C Average Effective Ambient Temperature), Shock and Vibration.

Output Enable / Disable Function

Parameter	Min.	Typ.	Max.	Units	Notes
Input Voltage (Pin1), Output Enable	0.7V _{CC}			V	Or Open
Input Voltage (Pin1), Output Disable (low power standby)			0.3V _{CC}	V	Output is Hi-Z
Output Disable Delay			100	ns	
Output Enable Delay			100	ns	
Start Up Time			10	ms	

TYPE NX 7.0x5.0 SEAM SEALED CRYSTAL CLOCK OSCILLATOR

NX72F6208Z

VER. A 26-Feb-15

TEST CIRCUIT

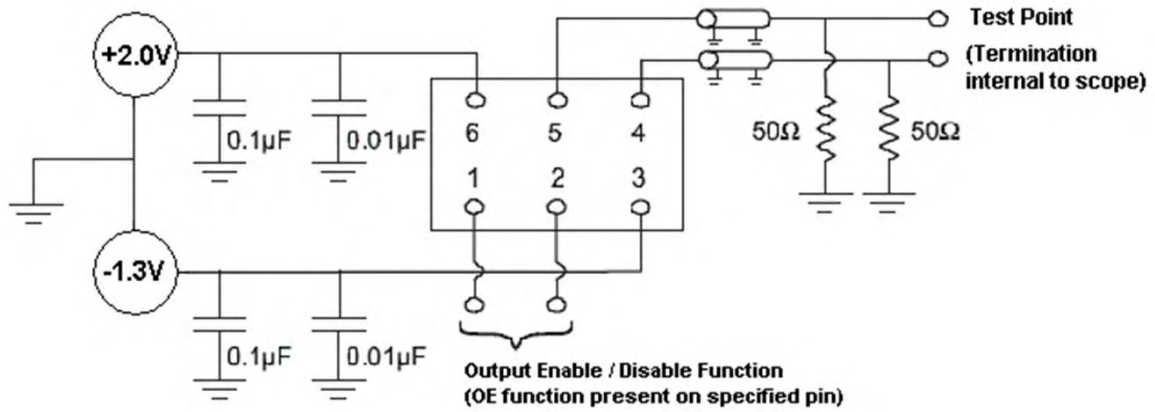

OUTPUT WAVEFORM

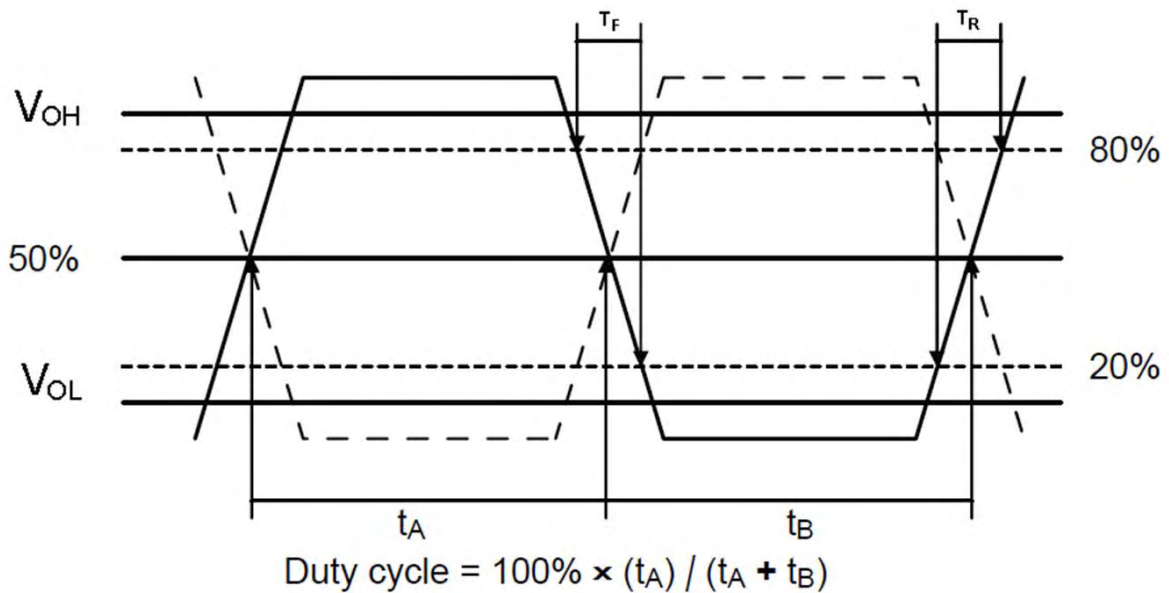

TYPE NX 7.0x5.0 SEAM SEALED CRYSTAL CLOCK OSCILLATOR

NX72F6208Z

VER. A 26-Feb-15

RELIABILITY SPECIFICATIONS

ENVIRONMENTAL:

- a) THERMAL SHOCK: MIL-STD-883, Method 1011, Condition A
- b) MOISTURE RESISTANCE: MIL-STD-883, Method 1004
- c) VIBRATION: MIL-STD-883, Method 2007, Condition A
- d) RESISTANCE TO SOLDERING HEAT: J-STD-020D Table 5-2 Pb-free devices (except 2 cycles max)
- e) HAZARDOUS SUBSTANCE: Pb - free and RoHS/Green Compliant.

MECHANICAL:

- a) SHOCK: MIL-STD-883, Method 2002, Condition B
- b) SOLDERABILITY: JESD22-B102-D Method 2 (Preconditioning E)
- c) TERMINAL STRENGTH: MIL-STD-883, Method 2004, Test Condition D
- d) GROSS LEAK: MIL-STD-883, Method 1014, Condition C
- e) FINE LEAK: MIL-STD-883, Method 1014, Condition A2, $R1=2 \times 10^{-8}$ atm cc/s
- f) SOLVENT RESISTANCE: MIL-STD-202, Method 215

SUGGESTED IR REFLOW PROFILE

*As per IPC-JEDEC J-STD-020D

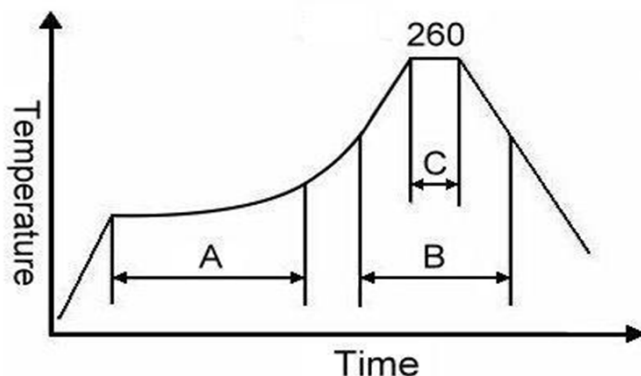

Note:

	Stage	Temperature	Time
A	Preheat	150~200°C	60~120 Sec
B	Primary Heat	217°C	60~150 Sec
C	Peak	260°C	10 Sec

For soldering reflow profile and reliability test ratings go to: <http://www.pericom.com/pdf/sre/reflow.pdf>

TYPE NX 7.0x5.0 SEAM SEALED CRYSTAL CLOCK OSCILLATOR

NX72F6208Z

VER. A 26-Feb-15

MARKING

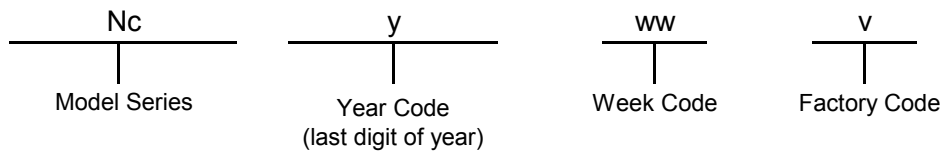
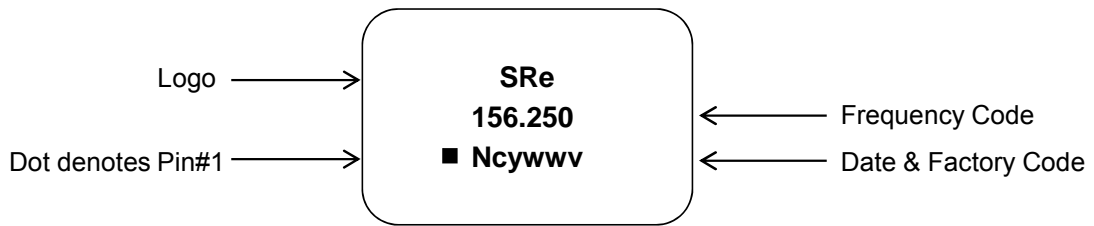

MECHANICAL DRAWINGS (Scale:None. Dimensions are in mm.)

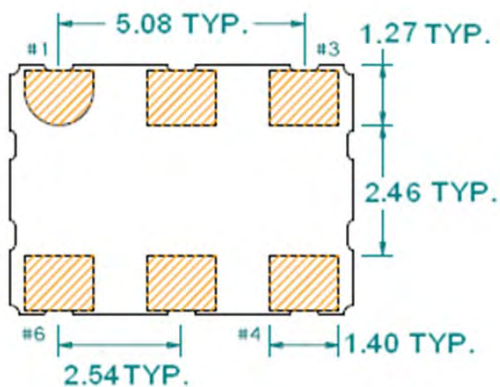
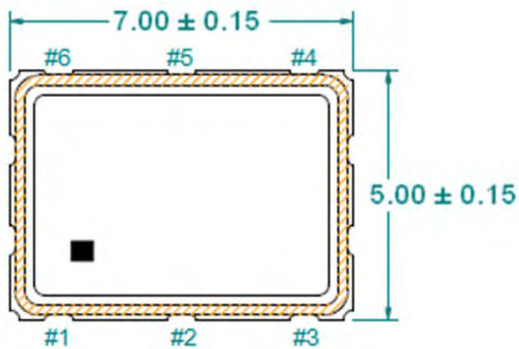

Recommended Land Pattern*

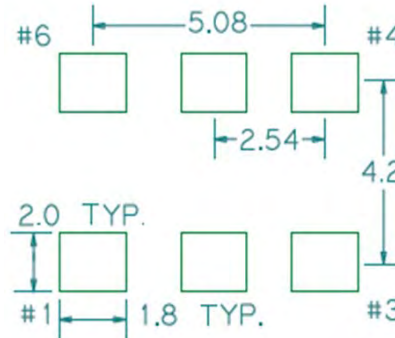

*External high-frequency power decoupling is recommended. (see test circuit for minimum recommendation). To ensure optimal performance, do not route traces beneath the package.

Pin	Function
1	OE
2	NC
3	Ground
4	Q
5	\overline{Q}
6	V _{CC}

TYPE NX 7.0x5.0 SEAM SEALED CRYSTAL CLOCK OSCILLATOR

NX72F6208Z

VER. A 26-Feb-15

TAPE&REEL

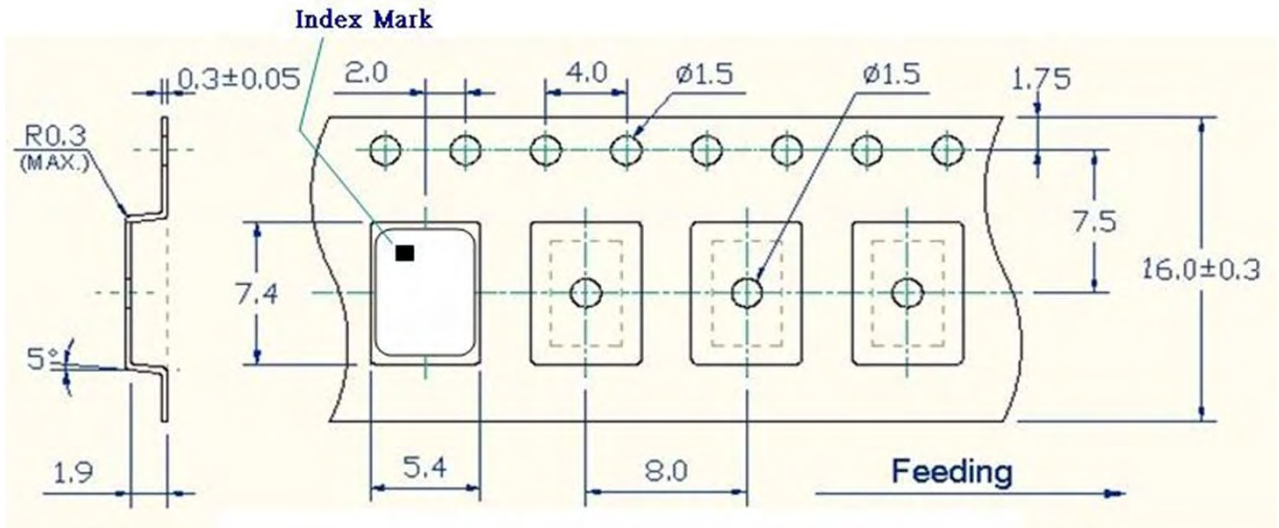

1. 230mm minimum leader which consist of carrier and/or tape followed by a minimum of 160mm of empty carrier tape sealed with cover tape.
2. 160mm minimum trailer of empty carrier tape sealed with cover tape.

TYPE NX 7.0x5.0 SEAM SEALED CRYSTAL CLOCK OSCILLATOR

NX72F6208Z

VER. A 26-Feb-15

PACKING

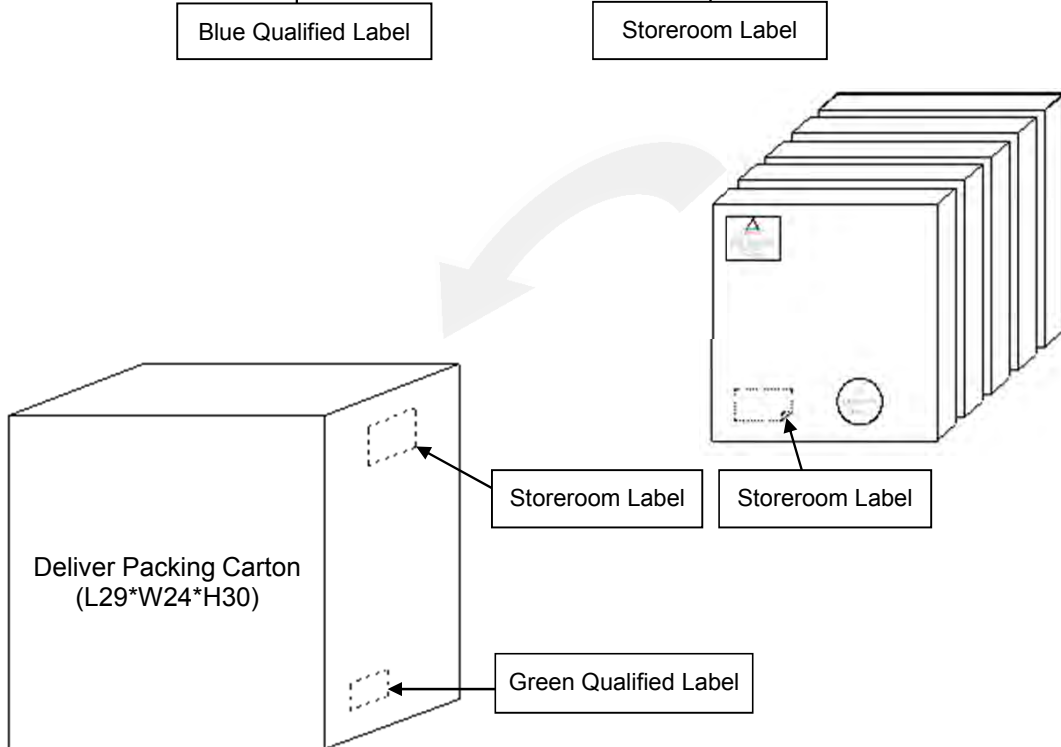
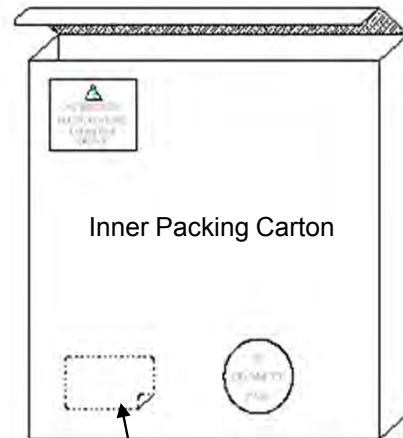
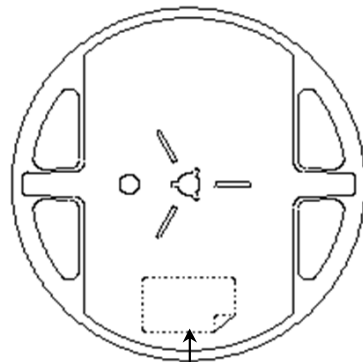
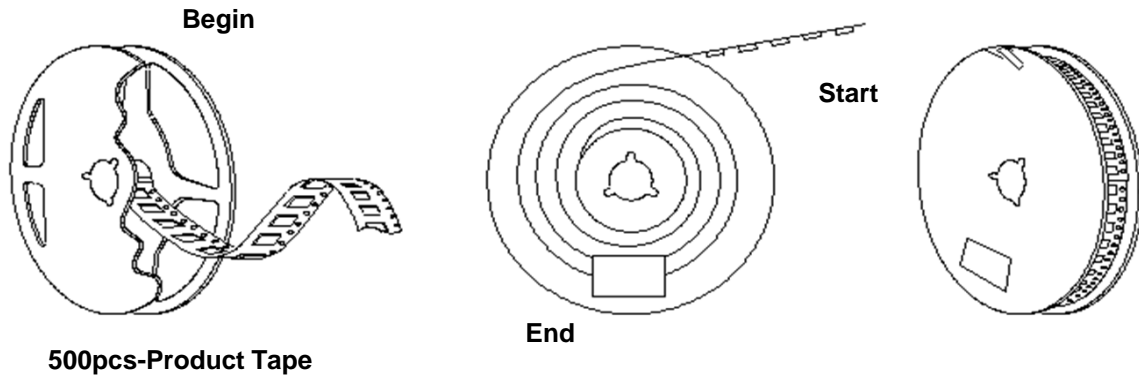

X-ON Electronics

Largest Supplier of Electrical and Electronic Components

Click to view similar products for [Standard Clock Oscillators](#) category:

Click to view products by [Diodes Incorporated](#) manufacturer:

Other Similar products are found below :

[601252](#) [F335-12](#) [F335-25](#) [F535L-33.333](#) [F535L-50](#) [ASV-20.000MHZ-LR-T](#) [ECS-2018-160-BN-TR](#) [EL13C7-H2F-125.00M](#) [MXO45HS-2C-66.6666MHZ](#) [SiT8209AI-32-33E-125.000000](#) [SM4420TEV-40.0M-T1K](#) [F335-24](#) [F335-40](#) [F535L-10](#) [F535L-16](#) [F535L-24](#) [F535L-27](#) [F535L-48](#) [PE7744DW-100.0M](#) [CSX-750FCC14745600T](#) [ASF1-3.686MHZ-N-K-S](#) [XO57CTECNA3M6864](#) [ECS-2100A-147.4](#) [601251](#) [EP16E7E2H26.000MTR](#) [SIT8918AA-11-33S-16.000000G](#) [XO3003](#) [9120AC-2D2-33E212.500000](#) [9102AI-243N25E100.00000](#) [8208AC-82-18E-25.00000](#) [ASDK2-32.768KHZ-LR-T3](#) [8008AI-72-XXE-24.545454E](#) [8004AC-13-33E-133.33000X](#) [AS-4.9152-16-SMD-TR](#) [ASFL1-48.000MHZ-LC-T](#) [SIT8920AM-31-33E-25.0000](#) [DSC1028DI2-019.2000](#) [9121AC-2C3-25E100.00000](#) [9102AI-233N33E100.00000X](#) [9102AI-233N25E200.00000](#) [9102AI-232H25S125.00000](#) [9102AI-133N25E200.00000](#) [9102AC-283N25E200.00000](#) [9001AC-33-33E1-30.000](#) [3921AI-2CF-33NZ125.000000](#) [5730-1SF](#) [PXA000010](#) [SIT1602BC-83-33E-10.000000Y](#) [8003AI-12-33S-40.00000Y](#) [1602BI-13-33S-19.200000E](#)