

PLL Clock Multiplier

Features

- Zero ppm multiplication error
- Input crystal frequency of 5 - 40 MHz
- Input clock frequency of 4 - 50 MHz
- Output clock frequencies up to 200 MHz
- Low period jitter 80ps (100~200MHz)
- Duty cycle of 45/55% of output clock up to 160MHz
- 9 selectable frequencies controlled by S0, S1 pins
- Operating voltages of 3.0 to 5.5V
- Lead free SOIC-8 package

Pin Configuration

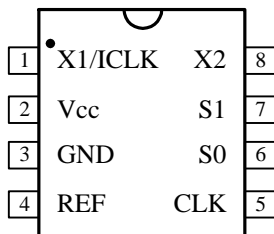

SOIC-8 package

Pin Description

Name	Pin No.	Type	Description
X1/ICLK	1	X1	Crystal connection or clock input.
Vcc	2	P	Connect to +3.3V or +5V.
GND	3	P	Connect to ground.
REF	4	O	Buffered crystal oscillator output clock
CLK	5	O	Clock output per <i>Clock Output Table</i> .
S0	6	T1	Multiplier select pin 0, connect to GND or Vcc or floating (no connection).
S1	7	T1	Multiplier select pin 1, connect to GND or Vcc or floating (no connection).
X2	8	XO	Crystal connection. Leave unconnected for clock input.

Description

This Clock Multiplier is the most cost-effective way to generate a high quality, high frequency clock outputs from lower frequency crystal or clock input. It is designed to replace crystal oscillators in most electronic systems, clock multipliers and frequency translation devices with low output jitter. The device implements a standard fundamental mode using PLL techniques and inexpensive crystal to produce output clocks up to 200 MHz.

The internal Logic divider is to generate nine different popular multiplication factors, allowing one chip to output many common frequencies.

Clock Output Table

S1	S0	CLK
0	0	$\times 4^{1)}$
0	M ²⁾	$\times (16/3)$
0	1	$\times 5$
M	0	$\times 2.5$
M	M	$\times 2$
M	1	$\times (10/3)$
1	0	$\times 6$
1	M	$\times 3$
1	1	$\times 8$

1) **Note:** CLK output frequency=ICLK \times 4.

2) **Note:** M=Leave unconnected (self-biases to Vcc/2).

Block Diagram

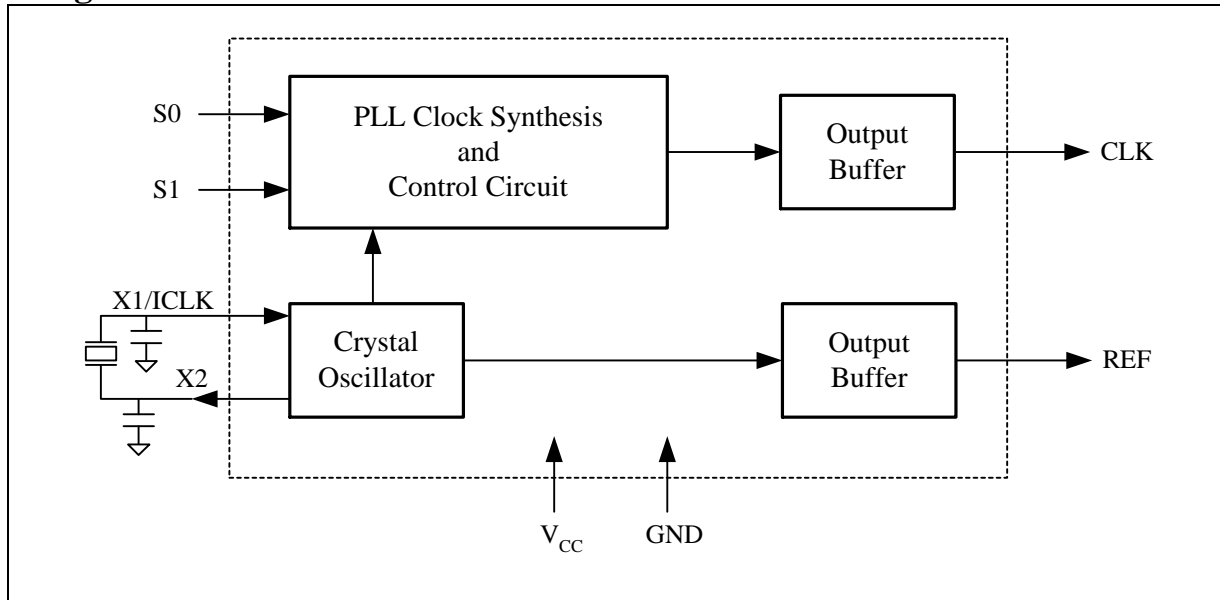

External Components

Decoupling Capacitor

As with any high-performance mixed-signal IC, the PT7C4512 must be isolated from system power supply noise to perform optimally. A decoupling capacitor of 0.01 μ F or 0.1 μ F must be connected between VCC and the GND. It must be connected close to the PT7C4512 to minimize lead inductance. No external power supply filtering is required for the PT7C4512.

Series Termination Resistor

A 33 Ω terminating resistor can be used next to the CLK pin for trace lengths over one inch.

Crystal Load Capacitors

There is no on-chip capacitance build-in chip. A parallel resonant, fundamental mode crystal should be used. The device crystal connections should include

pads for small capacitors from X1 to ground and from X2 to ground. These capacitors are used to adjust the stray capacitance of the board to match the nominally required crystal load capacitance. Because load capacitance can only be increased in this trimming process, it is important to keep stray capacitance to a minimum by using very short PCB traces (and no vias) between the crystal and device. Crystal capacitors, if needed, must be connected from each of the pins X1 and X2 to ground. The value (in pF) of these crystal caps should equal $C_L * 2$. In this equation, C_L = crystal load capacitance in pF. Example: For a crystal with a 15 pF load capacitance, each crystal capacitor would be 30pF.

Maximum Ratings

Storage Temperature.....	-65 $^{\circ}$ C to +150 $^{\circ}$ C
Ambient Operating Temperature.....	-40 $^{\circ}$ C to +85 $^{\circ}$ C
Supply Voltage to Ground Potential (V _{CC}).....	-0.3V to +7.0V
Inputs(Referenced to GND).....	-0.5V to V _{CC} +0.5V
Clock Output(Referenced to GND).....	-0.5V to V _{CC} +0.5V
Soldering Temperature(Max of 10 seconds).....	260 $^{\circ}$ C (Max. 10s)

Note:

Stresses greater than those listed under MAXIMUM RATINGS may cause permanent damage to the device. This is a stress rating only and functional operation of the device at these or any other conditions above those indicated in the operational sections of this specification is not implied. Exposure to absolute maximum rating conditions for extended periods may affect reliability.

Recommended Operating Conditions

Sym	Parameter	Conditions	Min	Typ	Max	Unit
V _{CC}	Supply voltage	-	3.0	-	5.5	V
T _A	Operating temperature	-	-40	-	+85	$^{\circ}$ C

DC Electrical Characteristics

($V_{CC} = 3.3V \pm 0.3V$, $T_A = -40 \sim 85 \text{ }^\circ\text{C}$, unless otherwise noted)

Sym.	Parameter	Test Condition	Pin	Min.	Typ.	Max.	Unit
V _{CC}	Supply Voltage	-	V _{CC}	3	3.3	3.6	V
I _{CC}	Supply Current	no load, 20MHz crystal, 100MHz output	V _{CC}	-	12	20	mA
V _{IH}	Input Logic High	-	ICLK	(V _{CC} /2)+1	V _{CC} /2	-	V
V _{IL}	Input Logic Low	-	ICLK	-	V _{CC} /2	(V _{CC} /2)-1	V
V _{IH}	Input Logic High	-	S0, S1	V _{CC} -0.5	-	-	V
V _{IM}	Input mid-level	-	S0, S1	-	V _{CC} /2	-	V
V _{IL}	Input Logic Low	-	S0, S1	-	-	0.5	V
V _{OH}	High-level output voltage	I _{OH} = -12mA	CLK	2.4	-	-	V
V _{OL}	Low-level output voltage	I _{OL} = 12mA	CLK	-	-	0.4	V
I _S	Short Circuit Current	-	CLK	-	±30	-	mA

($V_{CC} = 5.0V \pm 0.5V$, $T_A = -40 \sim 85 \text{ }^\circ\text{C}$, unless otherwise noted)

Sym.	Parameter	Test Condition	Pin	Min.	Typ.	Max.	Unit
V _{CC}	Supply Voltage	-	V _{CC}	4.5	5.0	5.5	V
I _{CC}	Supply Current	no load, 20MHz crystal, 100MHz output	V _{CC}	-	20	30	mA
V _{IH}	Input Logic High	-	ICLK	(V _{CC} /2)+1	V _{CC} /2	-	V
V _{IL}	Input Logic Low	-	ICLK	-	V _{CC} /2	(V _{CC} /2)-1	V
V _{IH}	Input Logic High	-	S0, S1	V _{CC} -0.4	-	-	V
V _{IM}	Input mid-level	-	S0, S1	-	V _{CC} /2	-	V
V _{IL}	Input Logic Low	-	S0, S1	-	-	0.4	V
V _{OH}	High-level output voltage	I _{OH} = -12mA	CLK	V _{CC} -0.5	-	-	V
V _{OL}	Low-level output voltage	I _{OL} = 12mA	CLK	-	-	0.4	V
I _S	Short Circuit Current	-	CLK	-	±70	-	mA

Test circuits

1>Load circuit for output clock duty cycle, rise and fall time Measurement

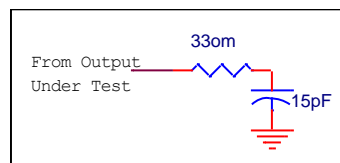

2>Timing Definitions for output clock rise and fall time Measurement

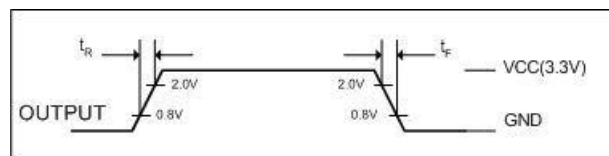
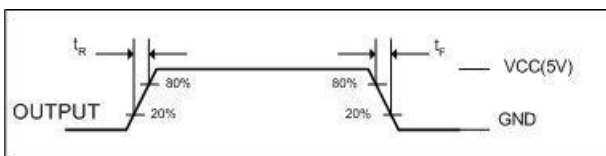

AC Electrical Characteristics

($V_{CC} = 3.3V \pm 0.3V$, $T_A = -40 \sim 85 \text{ }^\circ\text{C}$, unless otherwise noted)

Sym.	Parameter	Test Condition	Pin	Min.	Typ.	Max.	Unit
f_{IN}	Input Frequency	Crystal	ICLK	5	-	40	MHz
		Clock	ICLK	4	-	50	MHz
f_{OUT}	Output Frequency**	$V_{CC}: 3.0$ to $3.6V$	CLK	20	-	180	MHz
t_R	Output clock rise time	0.8 to $2.0V$, with $15pF$ load	CLK	-	1	-	ns
t_F	Output clock fall time	2.0 to $0.8V$, with $15pF$ load	CLK	-	1	-	ns
Duty	Output clock duty cycle	At $V_{CC}/2$, below $160MHz$	CLK	45	50	55	%
		At $V_{CC}/2$, $160MHz$ to $180MHz$	CLK	40	-	60	%
	PLL bandwidth*	-	-	10	-	-	kHz
	Period Jitter	$70MHz \sim 160MHz$, $25C$	CLK	-	-	120	ps

Note:

*: Only reference for design

** : The phase relationship between input and output clocks can change at power up.

($V_{CC} = 5.0V \pm 0.5V$, $T_A = -40 \sim 85 \text{ }^\circ\text{C}$, unless otherwise noted)

Sym.	Parameter	Test Condition	Pin	Min.	Typ.	Max.	Unit
f_{IN}	Input Frequency	Crystal	ICLK	5	-	40	MHz
		Clock	ICLK	4	-	50	MHz
f_{OUT}	Output Frequency**	$V_{CC}: 4.5$ to $5.5V$	CLK	20	-	200	MHz
t_R	Output clock rise time	$20\% V_{CC}$ to $80\% V_{CC}$, with $15pF$ load	CLK	-	1.2	-	ns
t_F	Output clock fall time	$80\% V_{CC}$ to $20\% V_{CC}$, with $15pF$ load	CLK	-	1.2	-	ns
Duty	Output clock duty cycle	At $V_{CC}/2$, below $160MHz$	CLK	45	50	55	%
		At $V_{CC}/2$, $160MHz$ to $200MHz$	CLK	40	-	60	%
	PLL bandwidth*	-	-	10	-	-	kHz
	Period Jitter	$70MHz \sim 200MHz$, $25C$	CLK	-	-	120	ps

Note:

*: Only reference for design

** : The phase relationship between input and output clocks can change at power up.

Mechanical Information
SOIC-8

DOCUMENT CONTROL NO.
PD - 1001

REVISION: E
DATE: 07/06/99

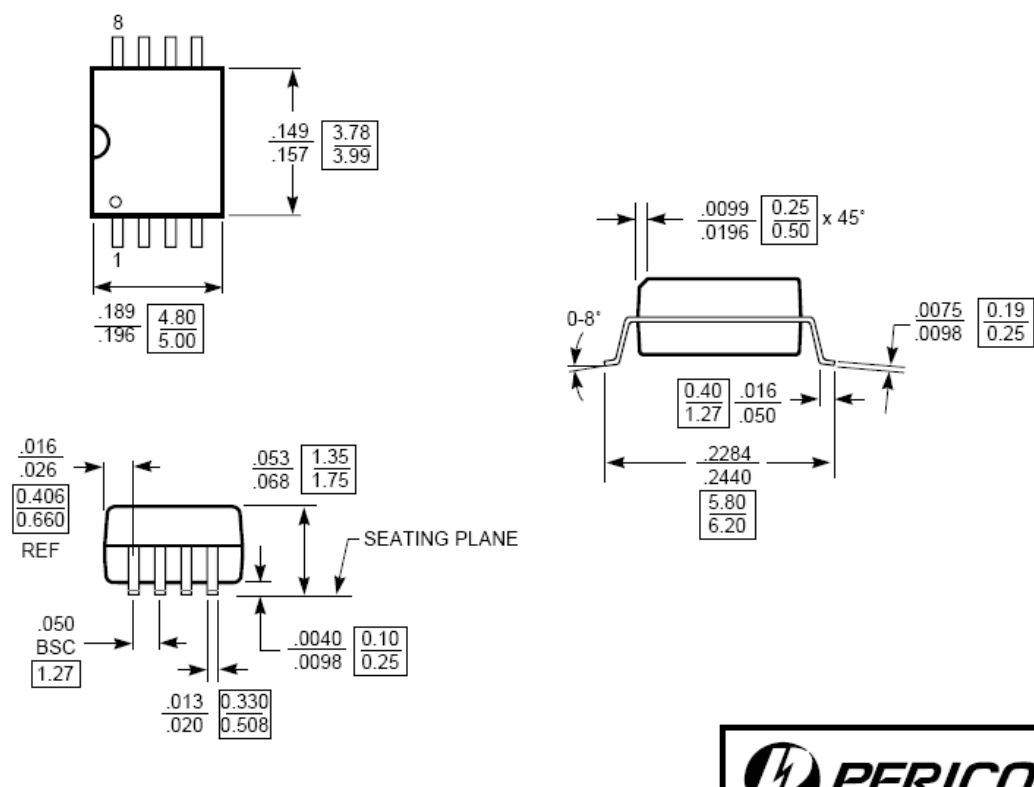

Notes:
 1) Controlling dimensions in millimeters.
 2) Ref: JEDEC MS - 012 AA



Pericom Semiconductor Corporation
 2380 Bering Drive, San Jose, CA 95131
 Tel: (408) 435-0800 • Fax: (408) 435-1100

DESCRIPTION: 8-PIN SOIC (150 MIL WIDE)

PACKAGE CODE: W8

Ordering Information

Part No.	Package Code	Package
PT7C4512WE	W	Lead free and Green 8-pin SOIC

Note:

- E = Pb-free and Green
- Adding X Suffix= Tape/Reel

Pericom Semiconductor Corporation • 1-800-435-2336 • www.pericom.com

Pericom reserves the right to make changes to its products or specifications at any time, without notice, in order to improve design or performance and to supply the best possible product. Pericom does not assume any responsibility for use of any circuitry described other than the circuitry embodied in Pericom product. The company makes no representations that circuitry described herein is free from patent infringement or other rights, of Pericom.

X-ON Electronics

Largest Supplier of Electrical and Electronic Components

Click to view similar products for [Clock Synthesizer/Jitter Cleaner](#) category:

Click to view products by [Diodes Incorporated](#) manufacturer:

Other Similar products are found below :

[MPC9230EIR2](#) [PL902166USY](#) [954204CGLF](#) [9LPRS485DGLF](#) [PL902167USY](#) [8V19N490ABDGI](#) [HMC822LP6CETR](#) [CDCE937QPWRQ1](#)
[PI6CX201ALE](#) [HMC826LP6CETR](#) [9LPRS355BGLF](#) [CDCEL913IPWRQ1](#) [ABMJB-903-101UMG-T5](#) [ABMJB-903-150UMG-T5](#) [ABMJB-](#)
[903-151UMG-T5](#) [AD9542BCPZ](#) [AD9578BCPZ](#) [HMC7044LP10BE](#) [9FG104EFILF](#) [308RILF](#) [840001BGI-25LF](#) [841N254BKILF](#)
[843004AGLF](#) [843801AGI-24LF](#) [844004BGI-01LF](#) [844S42BKILF](#) [8A34044C-000NLG](#) [954226AGLF](#) [9FG108EFLF](#) [9LPR363EGLF](#)
[9LPRS355BKLF](#) [9LPRS365BGLF](#) [9LPRS501SKLF](#) [MK2703BSILF](#) [GS4915-INE3](#) [9DB306BLLF](#) [ABMJB-902-155USY-T5](#) [ABMJB-902-](#)
[156USY-T5](#) [ABMJB-902-Q76USY-T5](#) [ABMJB-902-Q82USY-T5](#) [ABMJB-902-104USY-T5](#) [ABMJB-902-153USY-T5](#) [ABMJB-902-](#)
[154USY-T5](#) [ABMJB-902-Q42USY-T5](#) [ABMJB-902-Q57USY-T5](#) [ABMJB-902-Q74USY-T5](#) [ABMJB-902-Q78USY-T5](#) [650GI-44LF](#)
[8430252CGI-45LF](#) [5V41064NLG](#)