

Description

The ULN2003V12 and ULN2003F12 are multi-channel sink drivers comprised of 7-channel and 4-channel output stages respectively. The ULN2003V12 sink driver features 7 low output impedance drivers that minimize on-chip power dissipation and an actual low power upgrade version for popular ULN2003A family in real applications. When driving a typical 12V relay coil, a ULN2003V12 will dissipate 12 times lower power compared to ULN2003A. ULN2003F12 is a lower power variant benefiting from fewer channel integration and a better fit for applications requiring only 4-channel drivers, such as driving low voltage stepping motors, etc.

The ULN2003V12 and ULN2003F12 both support 3.3V to 5V CMOS logic input interface, thus making it compatible to a wide range of micro-controllers and other logic interfaces, and also feature an improved input interface that minimizes the input DC current drawn from the external drivers. The input RC snubber circuit integrated at ULN2003V12 and ULN2003F12 improves the performance in noisy operating conditions, and the internal pull-down resistor at input stage helps allow input logic to be tri-stated.

As shown in the Functional Diagram, each output of the ULN2003V12 and ULN2003F12 features an internal free-wheeling diode connected in a common-cathode configuration at the COM pin which provides flexibility of increasing current sink capability through combining several adjacent channels in parallel. Under typical conditions the ULN2003V12 can support up to 1.0A of load current when all 7-channels are connected in parallel.

Features

- 4- and 7-Channel High Current Sink Drivers
- Supports up to 20V Output Pull-up Voltage
- Low Output VOL of 0.6V (Typical) with
 - 100mA (Typ.) Current Sink per Channel at 3.3V Logic Input
 - 140mA (Typ.) Current Sink per Channel at 5.0V Logic Input
- Compatible to 3.3V and 5.0V Micro-Controllers and Logic Interface
- Internal Free-Wheeling Diodes for Inductive Kick-back Protection
- Input Pull-down Resistors Allows Tri-Stating the Input Driver
- Input RC-Snubber to Eliminate Spurious Operation in Noisy Environments
- ESD: 4kV HBM, 1kV CDM
- Available in 16-Pin SOIC, 16-Pin TSSOP and 10-Pin DFN3030 packages
- **Totally Lead-Free & Fully RoHS Compliant (Notes 1 & 2)**
- **Halogen and Antimony Free. "Green" Device (Note 3)**
- **For automotive applications requiring specific change control (i.e. parts qualified to AEC-Q100/101/200, PPAP capable, and manufactured in IATF 16949 certified facilities), please [contact us](mailto:contact@diodes.com) or your local Diodes representative. <https://www.diodes.com/quality/product-definitions/>**

Notes: 1. No purposely added lead. Fully EU Directive 2002/95/EC (RoHS), 2011/65/EU (RoHS 2) & 2015/863/EU (RoHS 3) compliant.
 2. See <https://www.diodes.com/quality/lead-free/> for more information about Diodes Incorporated's definitions of Halogen- and Antimony-free, "Green" and Lead-free.
 3. Halogen- and Antimony-free "Green" products are defined as those which contain <900ppm bromine, <900ppm chlorine (<1500ppm total Br + Cl) and <1000ppm antimony compounds.

Pin Assignments

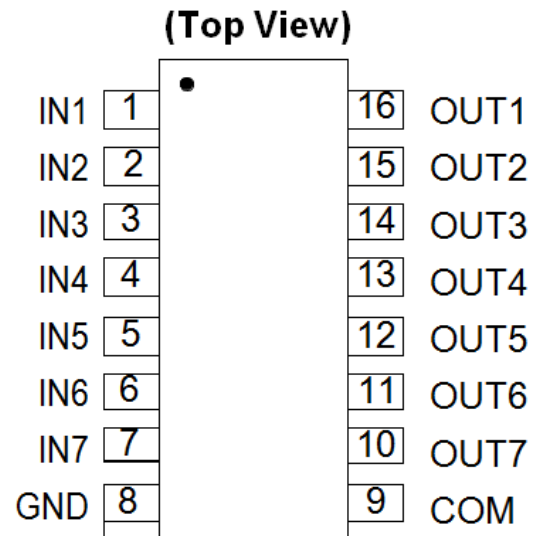

SO-16 / TSSOP-16

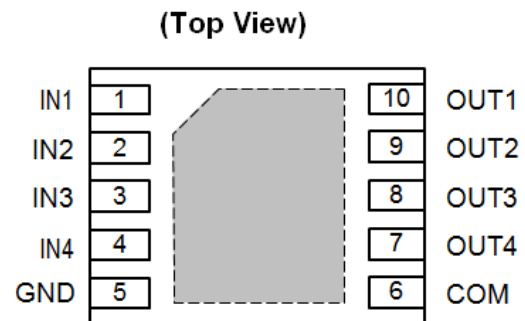

U-DFN3030-10

Applications

- Inputs Compatible with Popular Logic Types
- Relay Driver Applications
- Stepping Motor Applications
- Logic Level Shifter

Functional Diagram

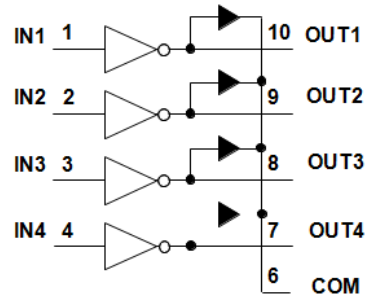
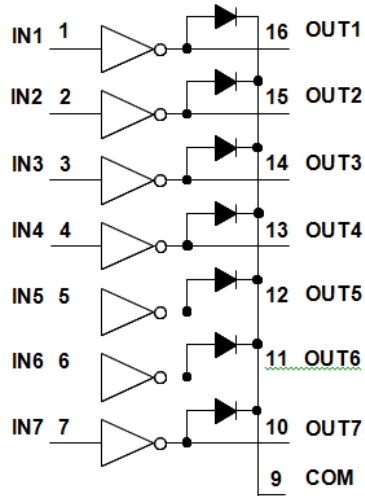

Pin Descriptions

Pin Name	Package Number			Description
	SO16	TSSOP16	DFN3030-10	
IN1 ~ IN7	1~7	1~7	1~4	Logic Input Pins IN1 through IN7
GND	8	8	5	Ground Reference Pin
COM	9	9	6	Internal Free-Wheeling Diode Common Cathode Pin
OUT7 ~ OUT1	10~16	10~16	7~10	Channel Output Pins OUT7 through OUT1

Functional Block Diagram (Single Channel)

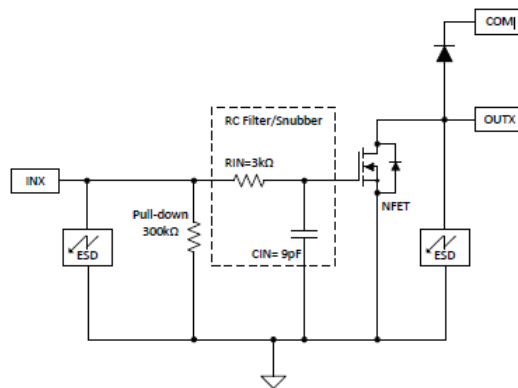

Absolute Maximum Ratings (@ $T_A = +25^\circ\text{C}$, unless otherwise specified.)

Symbol	Parameter	Rating		Unit
		Min	Max	
V_{IN}	Pin2 IN1~IN7 to GND Voltage	-0.3	5.5	V
V_{OUT}	Pins OUT1~OUT7 to GND Voltage	—	20	V
V_{COM}	Pin COM to GND Voltage	—	20	V
I_{GND}	Max GND-Pin Continuous Current ($+100^\circ\text{C} < T_J < +125^\circ\text{C}$)	—	700	mA
	Max GND-Pin Continuous Current ($T_J < +100^\circ\text{C}$)	—	1.0	A
P_D	Total Device Power Dissipation at $T_A = +85^\circ\text{C}$	16 Pin – SOIC	0.412	W
		16 Pin – TSSOP	0.277	W
		10 Pin – DFN3030	0.615	W
θ_{JA}	Thermal Resistance Junction-to-Ambient (Note 6)	16 Pin – SOIC	97	$^\circ\text{C/W}$
		16 Pin – TSSOP	144	
		10 Pin – DFN3030	65	
θ_{JC}	Thermal Resistance Junction-to-Case (Note 7)	16 Pin – SOIC	41	$^\circ\text{C/W}$
		16 Pin – TSSOP	61	
		10 Pin – DFN3030	17	
ESD	HBM	—	4	kV
	CDM	—	1	kV
T_J	Junction Temperature	-55	150	$^\circ\text{C}$
T_{STG}	Storage Temperature	-55	150	$^\circ\text{C}$

- Notes:
- Stresses beyond those listed under "absolute maximum ratings" may cause permanent damage to the device. These are stress ratings only. Functional operation of the device at these or any other conditions beyond those indicated under "recommended operating conditions" is not implied. Exposure to absolute-maximum-rated conditions for extended periods may affect device reliability.
 - All voltage values are with respect to the emitter/substrate terminal E, unless otherwise noted.
 - Maximum power dissipation is a function of $T_J(\text{max})$, θ_{JA} , and T_A . The maximum allowable power dissipation at any allowable ambient temperature is $P_D = (T_J(\text{max}) - T_A)/\theta_{JA}$. Operating at the absolute maximum T_J of $+150^\circ\text{C}$ can affect reliability.
 - Maximum power dissipation is a function of $T_J(\text{max})$, θ_{JC} , and T_A . The maximum allowable power dissipation at any allowable ambient temperature is $P_D = (T_J(\text{max}) - T_C)/\theta_{JC}$. Operating at the absolute maximum T_J of $+150^\circ\text{C}$ can affect reliability.

Recommended Operating Conditions (@ $T_A = +25^\circ\text{C}$, unless otherwise specified.)

Symbol	Parameter	Min	Max	Unit
V_{OUT}	Channel Off-Stage Output Pull-Up Voltage	—	—	V
V_{COM}	COM Pin Voltage	—	—	V
$I_{OUT(ON)}$	Per Channel Continuous Sink Current	$V_{INx} = 3.3\text{V}$	—	mA
		$V_{INx} = 5.0\text{V}$	—	
T_J	Operating Junction Temperature	-40	—	$^\circ\text{C}$

Electrical Characteristics (@ $T_A = +25^\circ\text{C}$, unless otherwise specified.)

Specified over the recommended junction temperature range $T_J = -40^\circ\text{C}$ to $+125^\circ\text{C}$ and over recommended operating conditions unless otherwise noted. Typical values are at $T_J = +25^\circ\text{C}$.

Symbol	Parameter	Test Conditions	Min	Typ	Max	Units
INPUTS IN1 THROUGH IN7 PARAMETERS						
$V_{I(on)}$	IN1~IN7 logic high input voltage	$V_{CE} = 2\text{V}$, $I_C = 300\text{mA}$	1.65	—	—	V
$V_{I(off)}$	IN1~IN7 logic low input voltage	$I_I = 250\mu\text{A}$, $I_C = 100\text{mA}$	—	—	0.6	V
$I_{I(on)}$	IN1~IN7 ON state input current	$I_F = 350\text{mA}$	—	12	25	μA
$I_{I(off)}$	IN1~IN7 OFF state input leakage	—	—	—	250	nA
OUTPUTS OUT1 THROUGH OUT7 PARAMETERS						
$V_{OL(vce-sat)}$	OUT1~OUT7 low-level output voltage	$V_{INX} = 3.3\text{V}$, $I_{OUTX} = 20\text{mA}$	—	0.12	0.15	V
		$V_{INX} = 3.3\text{V}$, $I_{OUTX} = 100\text{mA}$	—	0.6	0.75	
		$V_{INX} = 5.0\text{V}$, $I_{OUTX} = 20\text{mA}$	—	0.09	0.11	
		$V_{INX} = 5.0\text{V}$, $I_{OUTX} = 140\text{mA}$	—	0.6	0.75	
$I_{OUT(on)}$	OUT1~OUT7 ON-state continuous current at $V_{OUTX} = 0.6\text{V}$	$V_{INX} = 3.3\text{V}$, $V_{OUTX} = 0.6\text{V}$	80	100	—	V
		$V_{INX} = 5.0\text{V}$, $V_{OUTX} = 0.6\text{V}$	80	140	—	A
$I_{OUT(off)}$	OUT1~OUT7 OFF-state leakage current	$V_{INX} = 0\text{V}$, $V_{OUTX} = V_{COM} = 16\text{V}$	—	0.5	—	μA
SWITCHING PARAMETERS						
t_{PHL}	OUT1~OUT7 logic high propagation delay	$V_{INX} = 3.3\text{V}$, $V_{pull-up} = 12\text{V}$, $R_{pull-up} = 1\text{k}\Omega$	—	50	70	ns
t_{PLH}	OUT1~OUT7 logic low propagation delay	$V_{INX} = 3.3\text{V}$, $V_{pull-up} = 12\text{V}$, $R_{pull-up} = 1\text{k}\Omega$	—	121	140	ns
$t_{CHANNEL}$	Channel-to-channel delay	Over recommended operating conditions and with same test conditions on channels.	—	15	50	ns
R_{PD}	IN1~IN7 input pull-down resistance	—	210k	300k	390k	Ω
ζ	IN1~IN7 input filter time constant	—	—	9	—	ns
C_{OUT}	OUT1~OUT7 output capacitance	$V_{INX} = 3.3\text{V}$, $V_{OUTX} = 0.4\text{V}$	—	15	—	pF
FREE-WHEELING DIODE PARAMETERS						
V _F	Forward voltage drop	$I_{F-peak} = 140\text{mA}$, $V_F = V_{OUTX} - V_{COM}$	—	1.2	—	V
I_{F-peak}	Diode peak forward current	—	—	140	—	mA

Performance Characteristics

Output Current vs. Input Voltage (One Darlington)

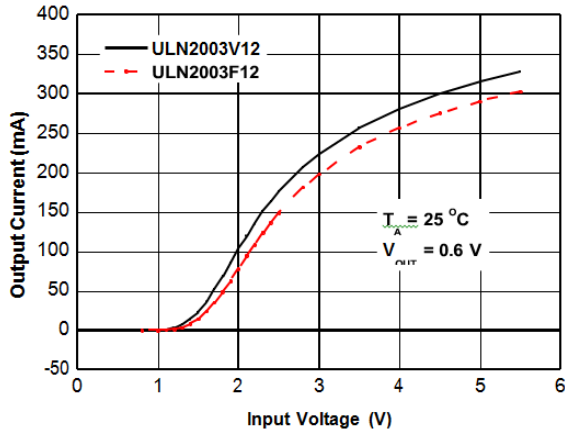

Output Current vs. Input Voltage (All Darlington's in Parallel)

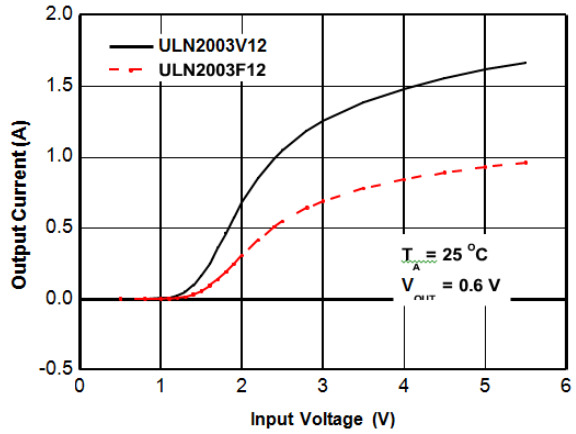

Output Current vs. Output Voltage

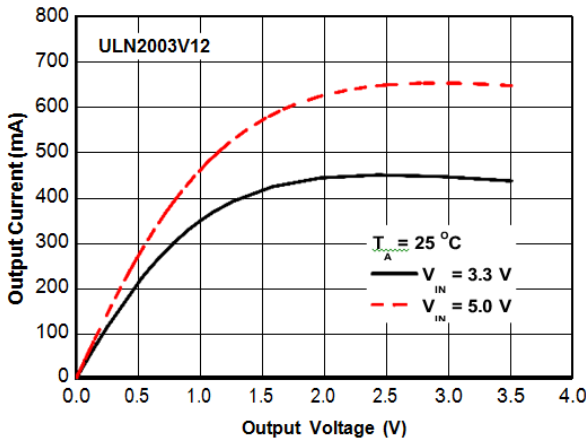

Output Current vs. Output Voltage

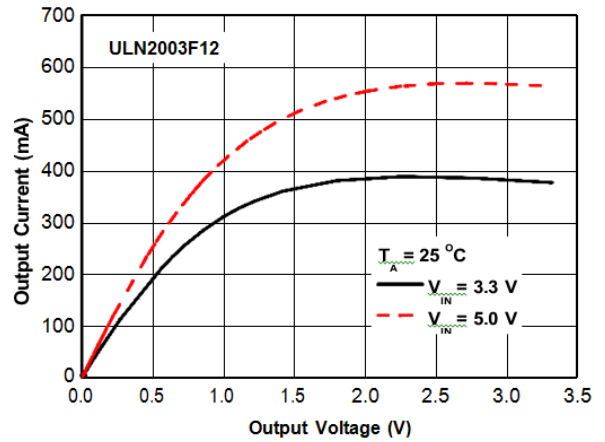

Performance Characteristics (continued)

Output Current vs. Output Voltage

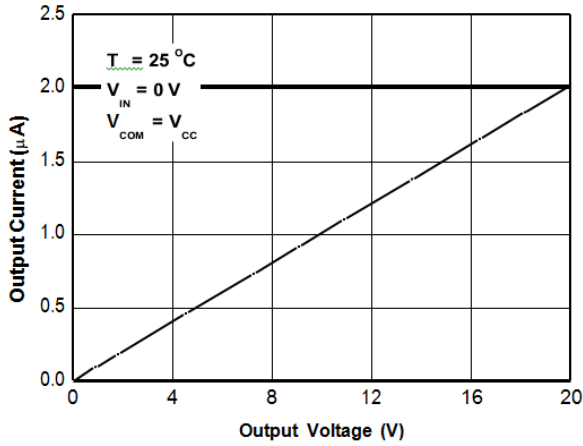

Diode Forward Voltage vs. Diode Forward Current

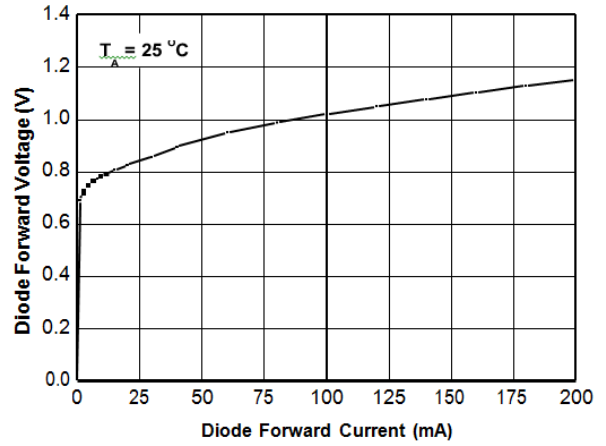

Diode Reverse Current vs. Diode Reverse Voltage

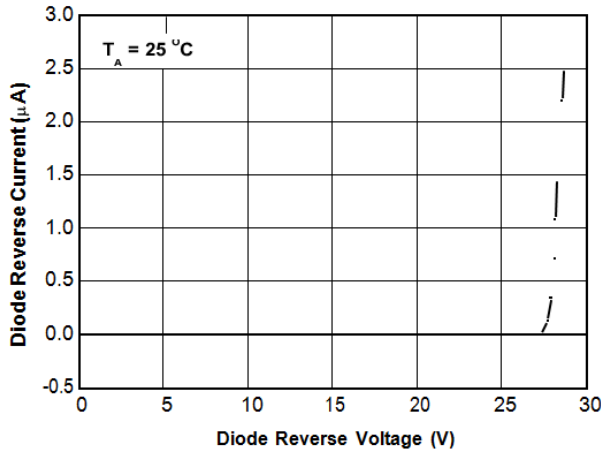

Ordering Information

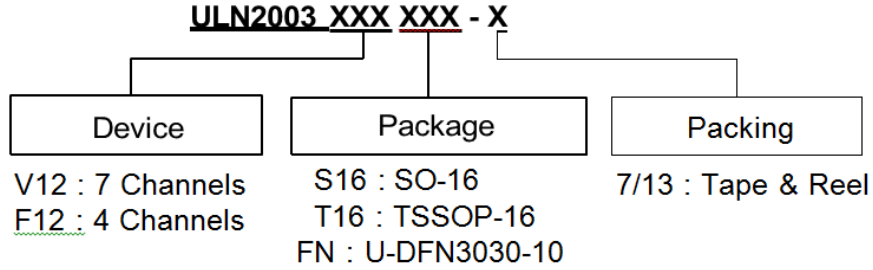

Device	Package Code	Packaging (Note 8)	7"/13" Tape and Reel	
			Quantity	Part Number Suffix
ULN2003V12S16-13	S16	SO-16	2,500/Tape & Reel	-13
ULN2003V12T16-13	T16	TSSOP-16	2,500/Tape & Reel	-13
ULN2003F12FN-7	FN	DFN3030-10	3,000/Tape & Reel	-7

Note: 8. For packaging details, go to our website at <https://www.diodes.com/design/support/packaging/diodes-packaging/>.

Marking Information

(1) SO-16 and TSSOP-16

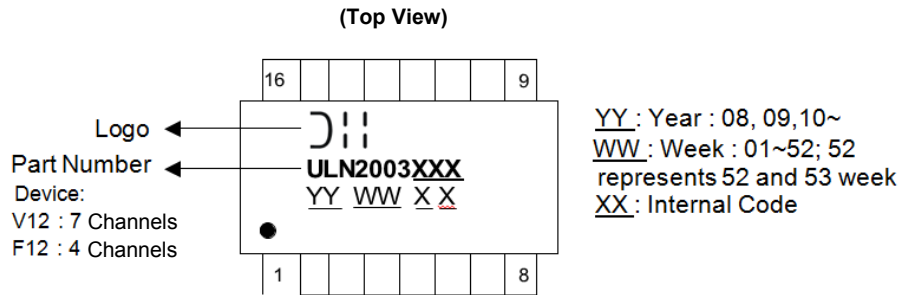

(2) DFN3030-10

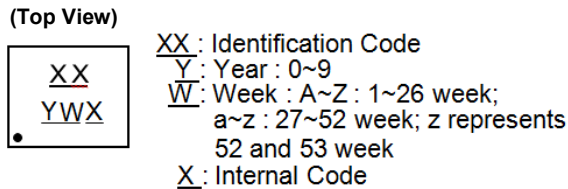

Part Number	Package	Identification Code
ULN2003F12FN-7	DFN3030-10	A3

Package Outline Dimensions

Please see <http://www.diodes.com/package-outlines.html> for the latest version.

SO-16

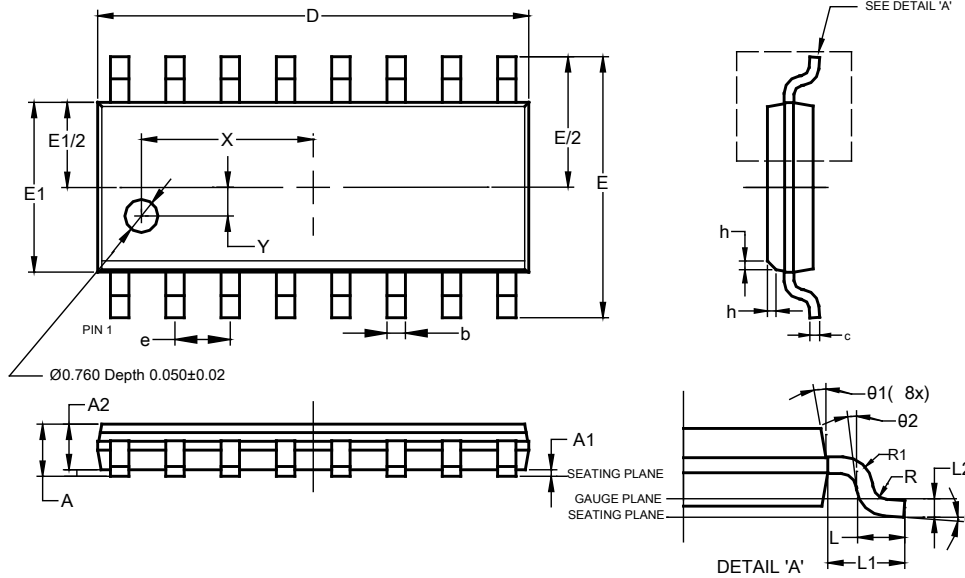

SO-16			
Dim	Min	Max	Typ
A	--	1.260	--
A1	0.10	0.23	--
A2	1.02	--	--
b	0.31	0.51	--
c	0.10	0.25	--
D	9.80	10.00	--
E	5.90	6.10	--
E1	3.80	4.00	--
e	1.27 BSC		
h	0.15	0.25	0.20
L	0.40	1.27	--
L1	1.04 REF		
L2	0.25 BSC		
R	0.07	--	--
R1	0.07	--	--
X	3.945 REF		
Y	0.661 REF		
theta	0°	8°	--
theta1	5°	15°	--
theta2	0°	--	--
All Dimensions in mm			

TSSOP-16

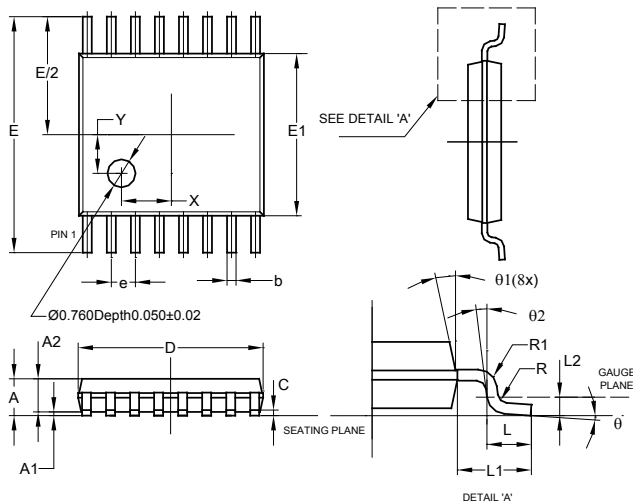

TSSOP-16			
Dim	Min	Max	Typ
A	-	1.08	-
A1	0.05	0.15	-
A2	0.80	0.93	-
b	0.19	0.30	-
c	0.09	0.20	-
D	4.90	5.10	-
E	6.40 BSC		
E1	4.30	4.50	-
e	0.65 BSC		
L	0.45	0.75	-
L1	1.00 REF		
L2	0.25 BSC		
R / R1	0.09	-	-
X	-	-	1.350
Y	-	-	1.050
theta	0°	8°	-
theta1	5°	15°	-
theta2	0°	-	-
All Dimensions in mm			

Package Outline Dimensions (continued)

Please see <http://www.diodes.com/package-outlines.html> for the latest version.

U-DFN3030-10

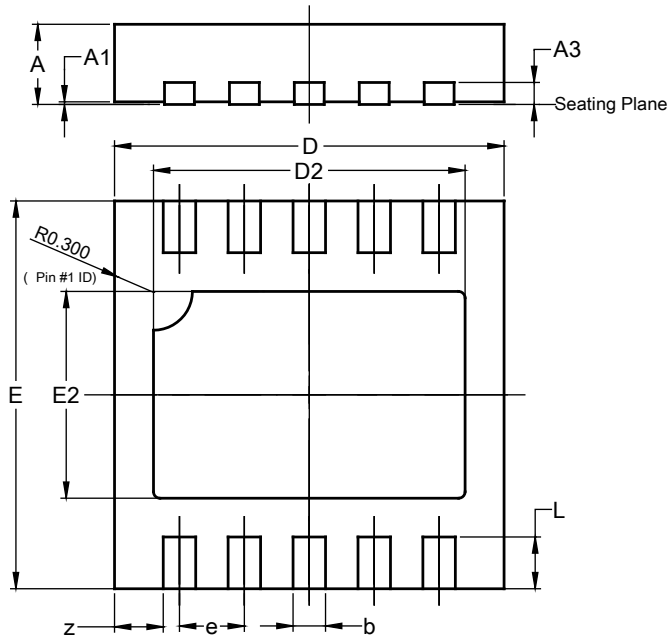

U-DFN3030-10			
Dim	Min	Max	Typ
A	0.57	0.63	0.60
A1	0.00	0.05	0.02
A3	—	—	0.15
b	0.20	0.30	0.25
D	2.90	3.10	3.00
D2	2.30	2.50	2.40
E	2.90	3.10	3.00
E2	1.50	1.70	1.60
e	--	--	0.50
L	0.25	0.55	0.40
z	—	—	0.375
All Dimensions in mm			

Suggested Pad Layout

Please see <http://www.diodes.com/package-outlines.html> for the latest version.

SO-16

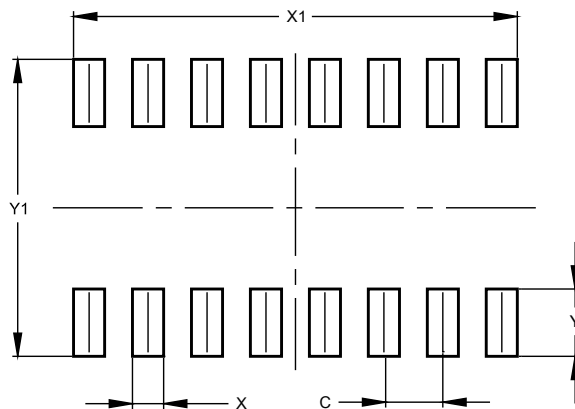

Dimensions	Value (in mm)
C	1.270
X	0.670
X1	9.560
Y	1.450
Y1	6.400

Suggested Pad Layout (continued)

Please see <http://www.diodes.com/package-outlines.html> for the latest version.

TSSOP-16

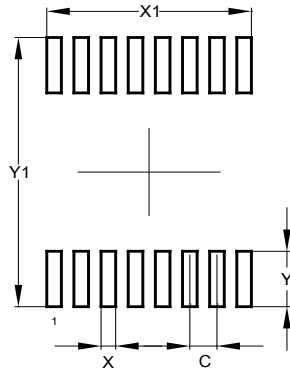

Dimensions	Value (in mm)
C	0.650
X	0.350
X1	4.900
Y	1.400
Y1	6.800

U-DFN3030-10

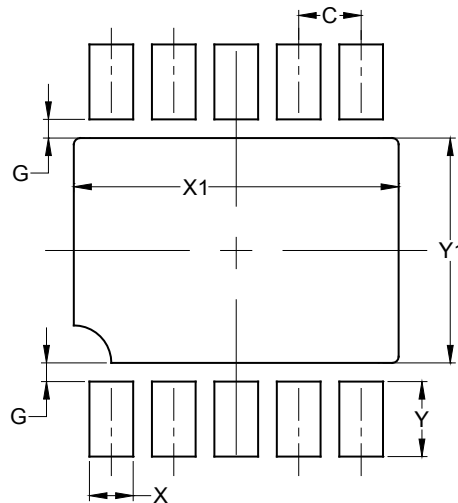

Dimensions	Value (in mm)
C	0.50
G	0.15
X	0.35
X1	2.60
Y	0.60
Y1	1.80

Mechanical Data

- Moisture Sensitivity: Level 3 per J-STD-020
- Terminals:
 - **SO-16** and **TSSOP-16**: Finish – Matte Tin Plated Leads, Solderable per MIL-STD-202, Method 208 ③
 - **DFN3030-10**: Finish NiPdAu over Copper Lead-Frame, Solderable per MIL-STD-202, Method 208 ③
- Weight:
 - **SO-16**: 0.129 grams (Approximate)
 - **TSSOP-16**: 0.055 grams (Approximate)
 - **DFN3030-10**: 0.016 grams (Approximate)

IMPORTANT NOTICE

1. DIODES INCORPORATED AND ITS SUBSIDIARIES (“DIODES”) MAKE NO WARRANTY OF ANY KIND, EXPRESS OR IMPLIED, WITH REGARDS TO ANY INFORMATION CONTAINED IN THIS DOCUMENT, INCLUDING, BUT NOT LIMITED TO, THE IMPLIED WARRANTIES OF MERCHANTABILITY, FITNESS FOR A PARTICULAR PURPOSE OR NON-INFRINGEMENT OF THIRD PARTY INTELLECTUAL PROPERTY RIGHTS (AND THEIR EQUIVALENTS UNDER THE LAWS OF ANY JURISDICTION).
2. The Information contained herein is for informational purpose only and is provided only to illustrate the operation of Diodes products described herein and application examples. Diodes does not assume any liability arising out of the application or use of this document or any product described herein. This document is intended for skilled and technically trained engineering customers and users who design with Diodes products. Diodes products may be used to facilitate safety-related applications; however, in all instances customers and users are responsible for (a) selecting the appropriate Diodes products for their applications, (b) evaluating the suitability of the Diodes products for their intended applications, (c) ensuring their applications, which incorporate Diodes products, comply the applicable legal and regulatory requirements as well as safety and functional-safety related standards, and (d) ensuring they design with appropriate safeguards (including testing, validation, quality control techniques, redundancy, malfunction prevention, and appropriate treatment for aging degradation) to minimize the risks associated with their applications.
3. Diodes assumes no liability for any application-related information, support, assistance or feedback that may be provided by Diodes from time to time. Any customer or user of this document or products described herein will assume all risks and liabilities associated with such use, and will hold Diodes and all companies whose products are represented herein or on Diodes’ websites, harmless against all damages and liabilities.
4. Products described herein may be covered by one or more United States, international or foreign patents and pending patent applications. Product names and markings noted herein may also be covered by one or more United States, international or foreign trademarks and trademark applications. Diodes does not convey any license under any of its intellectual property rights or the rights of any third parties (including third parties whose products and services may be described in this document or on Diodes’ website) under this document.
5. Diodes products are provided subject to Diodes’ Standard Terms and Conditions of Sale (<https://www.diodes.com/about/company/terms-and-conditions/terms-and-conditions-of-sales/>) or other applicable terms. This document does not alter or expand the applicable warranties provided by Diodes. Diodes does not warrant or accept any liability whatsoever in respect of any products purchased through unauthorized sales channel.
6. Diodes products and technology may not be used for or incorporated into any products or systems whose manufacture, use or sale is prohibited under any applicable laws and regulations. Should customers or users use Diodes products in contravention of any applicable laws or regulations, or for any unintended or unauthorized application, customers and users will (a) be solely responsible for any damages, losses or penalties arising in connection therewith or as a result thereof, and (b) indemnify and hold Diodes and its representatives and agents harmless against any and all claims, damages, expenses, and attorney fees arising out of, directly or indirectly, any claim relating to any noncompliance with the applicable laws and regulations, as well as any unintended or unauthorized application.
7. While efforts have been made to ensure the information contained in this document is accurate, complete and current, it may contain technical inaccuracies, omissions and typographical errors. Diodes does not warrant that information contained in this document is error-free and Diodes is under no obligation to update or otherwise correct this information. Notwithstanding the foregoing, Diodes reserves the right to make modifications, enhancements, improvements, corrections or other changes without further notice to this document and any product described herein. This document is written in English but may be translated into multiple languages for reference. Only the English version of this document is the final and determinative format released by Diodes.
8. Any unauthorized copying, modification, distribution, transmission, display or other use of this document (or any portion hereof) is prohibited. Diodes assumes no responsibility for any losses incurred by the customers or users or any third parties arising from any such unauthorized use.

Copyright © 2021 Diodes Incorporated

www.diodes.com

X-ON Electronics

Largest Supplier of Electrical and Electronic Components

Click to view similar products for [Gate Drivers](#) category:

Click to view products by [Diodes Incorporated](#) manufacturer:

Other Similar products are found below :

[00053P0231](#) [56956](#) [57.404.7355.5](#) [LT4936](#) [57.904.0755.0](#) [5882900001](#) [00600P0005](#) [00-9050-LRPP](#) [00-9090-RDPP](#) [5951900000](#) [01-1003W-10/32-15](#) [0131700000](#) [00-2240](#) [LTP70N06](#) [LVP640](#) [5J0-1000LG-SIL](#) [LY1D-2-5S-AC120](#) [LY2-US-AC240](#) [LY3-UA-DC24](#) [00576P0020](#) [00600P0010](#) [LZN4-UA-DC12](#) [LZNQ2M-US-DC5](#) [LZNQ2-US-DC12](#) [LZP40N10](#) [00-8196-RDPP](#) [00-8274-RDPP](#) [00-8275-RDNP](#) [00-8722-RDPP](#) [00-8728-WHPP](#) [00-8869-RDPP](#) [00-9051-RDPP](#) [00-9091-LRPP](#) [00-9291-RDPP](#) [0207100000](#) [0207400000](#) [01312](#) [0134220000](#) [60713816](#) [M15730061](#) [61161-90](#) [61278-0020](#) [6131-204-23149P](#) [6131-205-17149P](#) [6131-209-15149P](#) [6131-218-17149P](#) [6131-220-21149P](#) [6131-260-2358P](#) [6131-265-11149P](#) [CS1HCPU63](#)