

Product Summary

- Continuous Drain Source Voltage: 60V
- On-State Resistance: 500mΩ
- Nominal Load Current ($V_{IN} = 5V$): 1.3A
- Clamping Energy: 90mJ

Description

The DIODES™ ZXMS6004FF-7 is a self-protected low side IntelliFET® MOSFET with logic level input. It integrates overtemperature, overcurrent, overvoltage (active clamp) and ESD protected logic level functionality. The ZXMS6004FF-7 is ideal as a general purpose switch driven from 3.3V or 5V microcontrollers in harsh environments where standard MOSFETs are not rugged enough.

Applications

- Especially suited for loads with a high in-rush current such as lamps and motors
- All types of resistive, inductive and capacitive loads in switching applications
- μC compatible power switches for 12V and 24V DC applications
- Automotive rated
- Replaces electromechanical relays and discrete circuits
- Linear mode capabilities – the current-limiting protection circuitry is designed to de-activate at low V_{DS} to minimize on state power dissipation. The maximum DC operating current is therefore determined by the thermal capability of the package/board combination, rather than by the protection circuitry. This does not compromise the product's ability to self-protect at low V_{DS} .

Features and Benefits

- Compact High Power Dissipation Package
- Low Input Current
- Logic Level Input (3.3V and 5V)
- Short Circuit Protection with Auto Restart
- Over Voltage Protection (Active Clamp)
- Thermal Shutdown with Auto Restart
- Overcurrent Protection
- Input Protection (ESD)
- High Continuous Current Rating
- **Totally Lead-Free & Fully RoHS Compliant (Notes 1 & 2)**
- **Halogen and Antimony Free. "Green" Device (Note 3)**
- **For automotive applications requiring specific change control (i.e.: parts qualified to AEC-Q100/101/104/200, PPAP capable, and manufactured in IATF 16949 certified facilities), please refer to the related automotive grade (Q-suffix) part. A listing can be found at <https://www.diodes.com/products/automotive/automotive-products/>.**
- **This part is qualified to JEDEC standards (as references in AEC-Q) for High Reliability. <https://www.diodes.com/quality/product-definitions/>**

Mechanical Data

- Package: SOT23F
- Package Material: Molded Plastic, "Green" Molding Compound. UL Flammability Classification Rating 94V-0
- Moisture Sensitivity: Level 1 per J-STD-020
- Terminals: Finish – Matte Tin Plated Leads, Solderable per MIL-STD-202, Method 208 (63)
- Weight: 0.012 grams (Approximate)

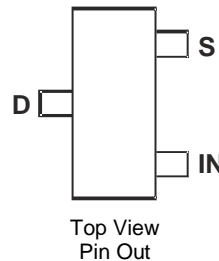

Ordering Information (Note 4)

Part Number	Package	Marking	Reel Size (inches)	Tape Width (mm)	Packing	
					Qty.	Carrier
ZXMS6004FF-7	SOT23F	1K6	7	8	3,000	Reel

- Notes:
1. No purposely added lead. Fully EU Directive 2002/95/EC (RoHS), 2011/65/EU (RoHS 2) & 2015/863/EU (RoHS 3) compliant.
 2. See <https://www.diodes.com/quality/lead-free/> for more information about Diodes Incorporated's definitions of Halogen- and Antimony-free, "Green" and Lead-free.
 3. Halogen- and Antimony-free "Green" products are defined as those which contain <900ppm bromine, <900ppm chlorine (<1500ppm total Br + Cl) and <1000ppm antimony compounds.
 4. For packaging details, go to our website at <https://www.diodes.com/design/support/packaging/diodes-packaging/>.

IntelliFET is a registered trademark of Diodes Incorporated.

Marking Information

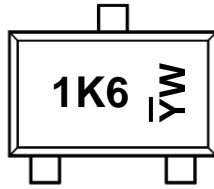

1K6 = Product Type Marking Code
 Y or \bar{Y} : Year: 0 to 9 (ex: 2 = 2022)
 W or \bar{W} : Week: A to Z: Week 1 to 26
 a to z: Week 27 to 52
 z: Represents Week 52 & 53

Functional Block Diagram

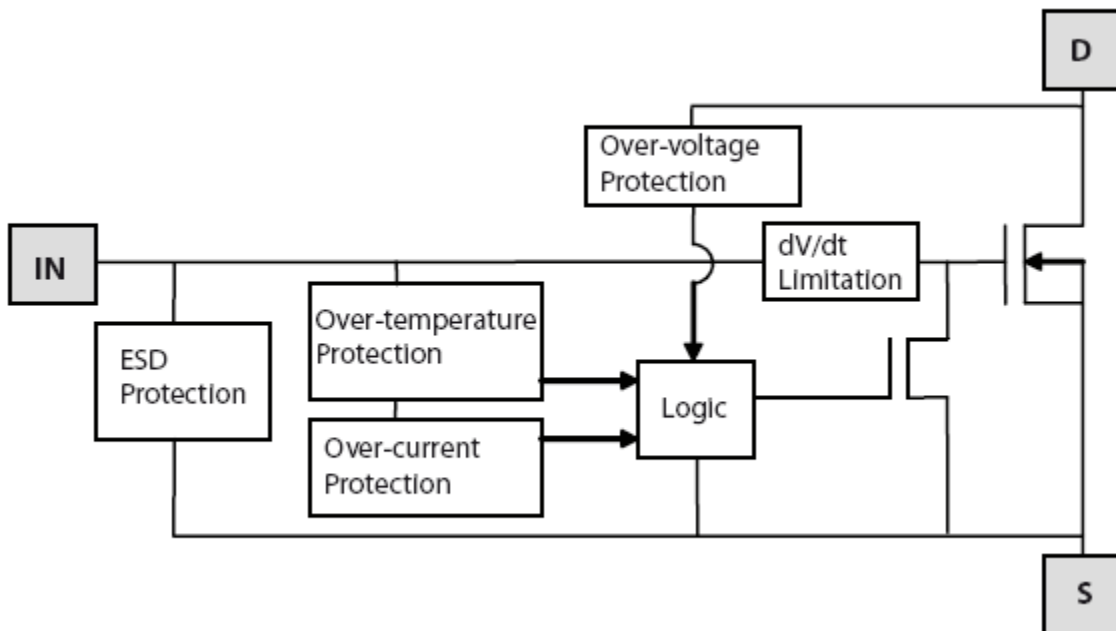

Absolute Maximum Ratings (@T_A = +25°C, unless otherwise specified.)

Characteristic	Symbol	Value	Unit
Continuous Drain-Source Voltage	V _{DS}	60	V
Drain-Source Voltage for Short Circuit Protection	V _{DS(SC)}	36	V
Continuous Input Voltage	V _{IN}	-0.5 ... +6	V
Continuous Input Current @ -0.2V ≤ V _{IN} ≤ 6V	I _{IN}	No Limit	mA
Continuous Input Current @ V _{IN} < -0.2V or V _{IN} > 6V		I _{IN} ≤ 2	
Pulsed Drain Current @ V _{IN} = 3.3V	I _{DM}	2	A
Pulsed Drain Current @ V _{IN} = 5V	I _{DM}	2.5	A
Continuous Source Current (Body Diode)	I _S	1	A
Pulsed Source Current (Body Diode)	I _{SM}	5	A
Unclamped Single Pulse Inductive Energy T _J = +25°C, I _D = 0.5A, V _{DD} = 24V	E _{AS}	90	mJ
Electrostatic Discharge (Human Body Model)	V _{ESD}	4,000	V
Charged Device Model	V _{CDM}	1,000	V

Thermal Characteristics (@T_A = +25°C, unless otherwise specified.)

Characteristic	Symbol	Value	Unit
Power Dissipation @ T _A = +25°C (Note 5)	P _D	0.83	W
Linear Derating Factor		6.66	
Power Dissipation @ T _A = +25°C (Note 6)	P _D	1.5	W
Linear Derating Factor		12.0	
Thermal Resistance, Junction to Ambient (Note 5)	R _{θJA}	150	°C/W
Thermal Resistance, Junction to Ambient (Note 6)	R _{θJA}	83	°C/W
Thermal Resistance, Junction to Case (Note 7)	R _{θJC}	44	°C/W
Operating Temperature Range	T _J	-40 to +150	°C
Storage Temperature Range	T _{STG}	-55 to +150	°C

Recommended Operating Conditions

The ZXMS6004FF-7 is optimized for use with μC operating from 3.3V and 5V supplies.

Characteristic	Symbol	Min	Max	Unit
Input Voltage Range	V _{IN}	0	5.5	V
Ambient Temperature Range	T _A	-40	+125	°C
High Level Input Voltage for MOSFET to be On	V _{IH}	3	5.5	V
Low Level Input Voltage for MOSFET to be Off	V _{IL}	0	0.7	V
Peripheral Supply Voltage (Voltage to Which Load is Referred)	V _P	0	36	V

- Notes:
5. For a device surface mounted on 15mm x 15mm single sided, 1oz weight copper on 1.6mm FR4 board, in still air conditions.
 6. For a device surface mounted on 50mm x 50mm single sided, 2oz weight copper on 1.6mm FR4 board, in still air conditions.
 7. Thermal resistance from junction and the mounting surfaces of the drain pins.

Typical Thermal Characteristics

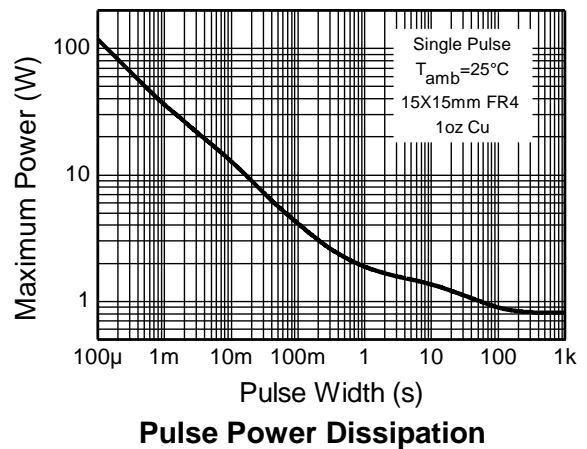
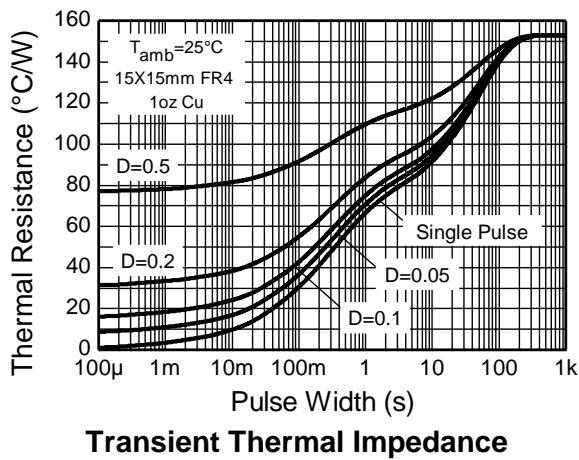
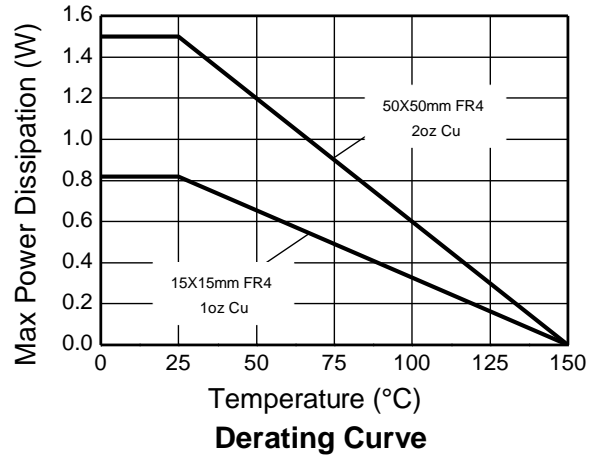
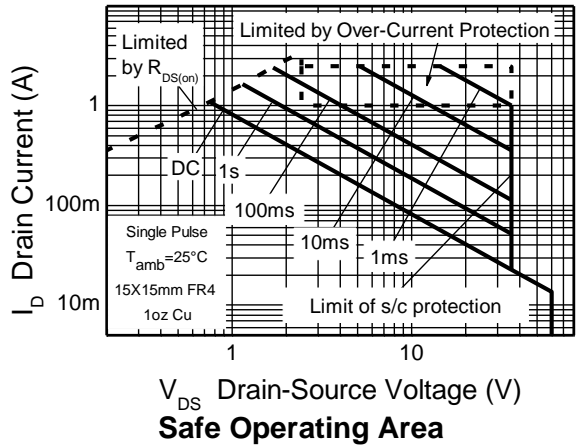

Electrical Characteristics (@T_A = +25°C, unless otherwise specified.)

Characteristic	Symbol	Min	Typ	Max	Unit	Test Condition
Static Characteristics						
Drain-Source Clamp Voltage	V _{DS(AZ)}	60	65	70	V	I _D = 10mA
Off-State Drain Current	I _{DSS}	—	—	500	nA	V _{DS} = 12V, V _{IN} = 0V
		—	—	1	μA	V _{DS} = 36V, V _{IN} = 0V
Input Threshold Voltage	V _{IN(TH)}	0.7	1	1.5	V	V _{DS} = V _{GS} , I _D = 1mA
Input Current	I _{IN}	—	60	100	μA	V _{IN} = +3V
		—	120	200		V _{IN} = +5V
Input Current while Overtemperature Active	—	—	—	220	μA	V _{IN} = +5V
Static Drain-Source On-State Resistance	R _{DS(ON)}	—	400	600	mΩ	V _{IN} = +3V, I _D = 0.5A
		—	350	500		V _{IN} = +5V, I _D = 0.5A
Continuous Drain Current (Note 5)	I _D	0.9	—	—	A	V _{IN} = 3V, T _A = +25°C
Continuous Drain Current (Note 6)		1.0	—	—		V _{IN} = 5V, T _A = +25°C
		1.2	—	—		V _{IN} = 3V, T _A = +25°C
		1.3	—	—		V _{IN} = 5V, T _A = +25°C
Current Limit (Note 8)	I _{D(LIM)}	0.7	1.7	—	A	V _{IN} = +3V
		1	2.2	—		V _{IN} = +5V
Dynamic Characteristics						
Turn-On Delay Time	t _{D(ON)}	—	5	—	μs	V _{DD} = 12V, I _D = 0.5A, V _{GS} = 5V
Rise Time	t _R	—	10	—		
Turn-Off Delay Time	t _{D(OFF)}	—	45	—		
Fall Time	t _F	—	15	—		
Overtemperature Protection						
Thermal Overload Trip Temperature (Note 9)	T _{JT}	+150	+175	—	°C	—
Thermal Hysteresis (Note 9)	f _F	—	+10	—	°C	—

- Notes:
5. For a device surface mounted on 15mm x 15mm single sided, 1oz weight copper on 1.6mm FR4 board, in still air conditions.
 6. For a device surface mounted on 50mm x 50mm single sided, 2oz weight copper on 1.6mm FR4 board, in still air conditions.
 7. Thermal resistance from junction and the mounting surfaces of the drain pins.
 8. The drain current is restricted only when the device is in saturation (see graph 'Typical Output Characteristic'). This allows the device to be used in the fully on-state without interference from the current limit. The device is fully protected at all drain currents, as the low power dissipation generated outside saturation makes current limit unnecessary.
 9. Overtemperature protection is designed to prevent device from destruction under fault conditions. Fault conditions are considered as "outside" normal operating range, so this part is not designed to withstand overtemperature for extended periods.

Typical Performance Characteristics

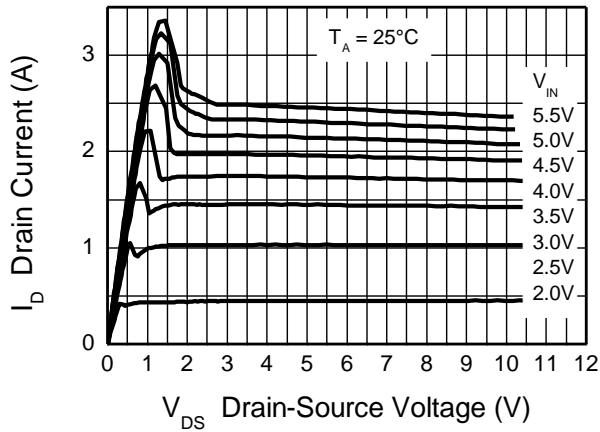

Typical Output Characteristic

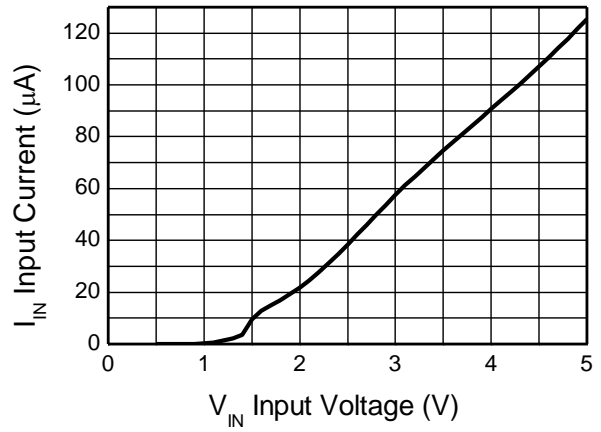

Input Current vs Input Voltage

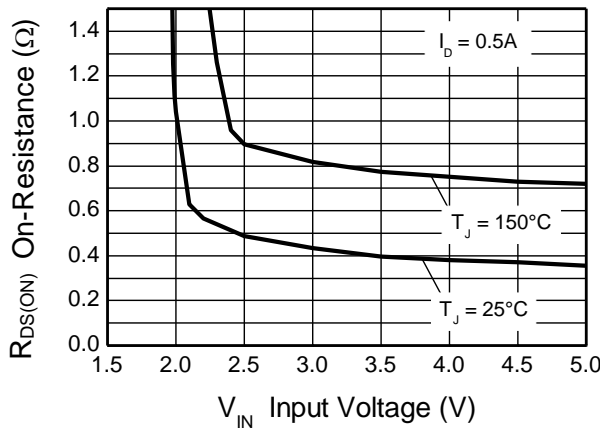

On-Resistance vs Input Voltage

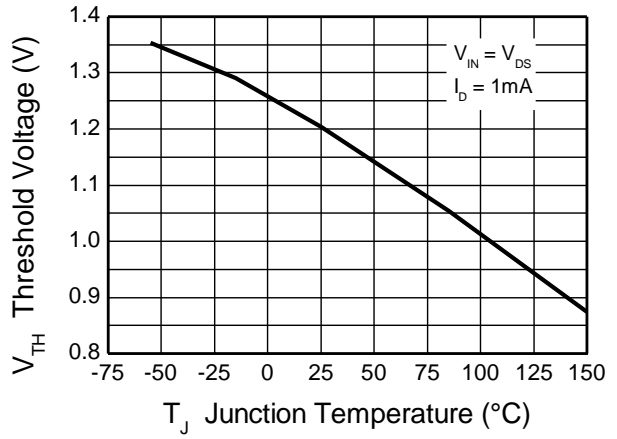

Threshold Voltage vs Temperature

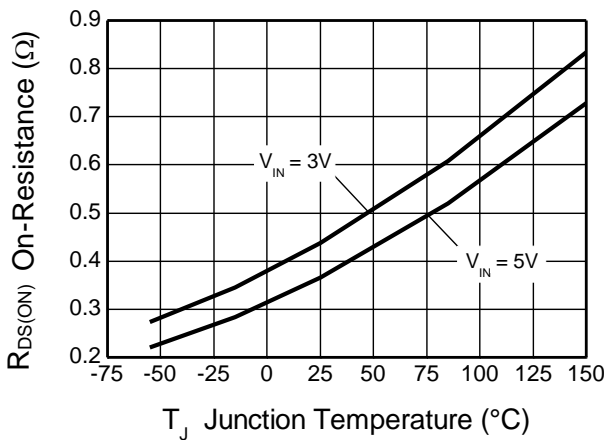

On-Resistance vs Temperature

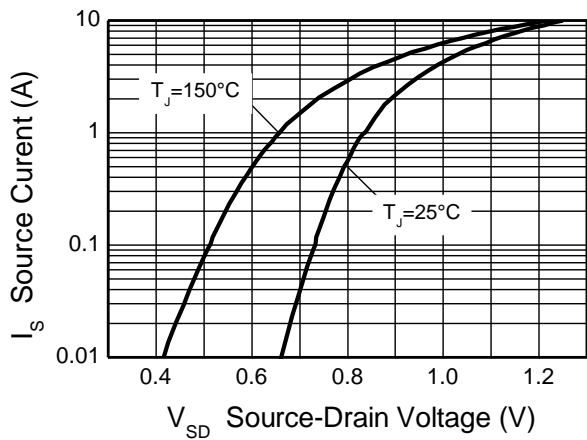

Reverse Diode Characteristic

Typical Performance Characteristics (continued)

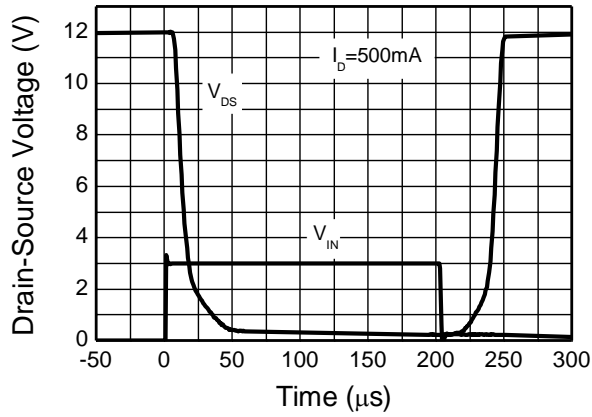

Switching Speed

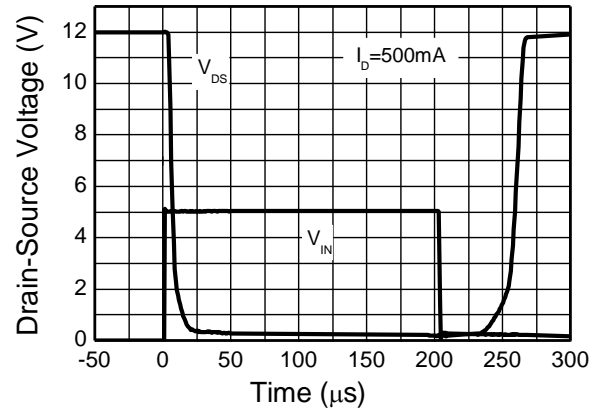

Switching Speed

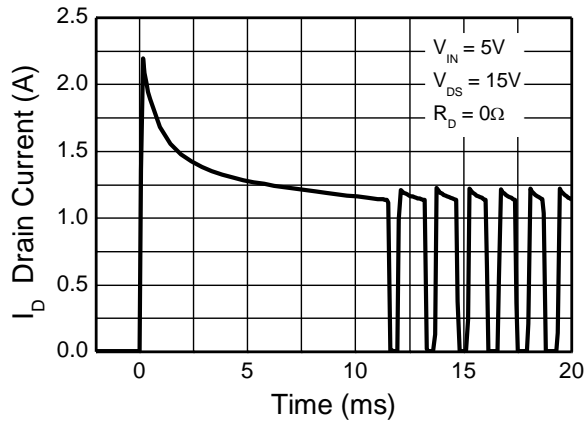

Typical Short Circuit Protection

Package Outline Dimensions

Please see <http://www.diodes.com/package-outlines.html> for the latest version.

SOT23F

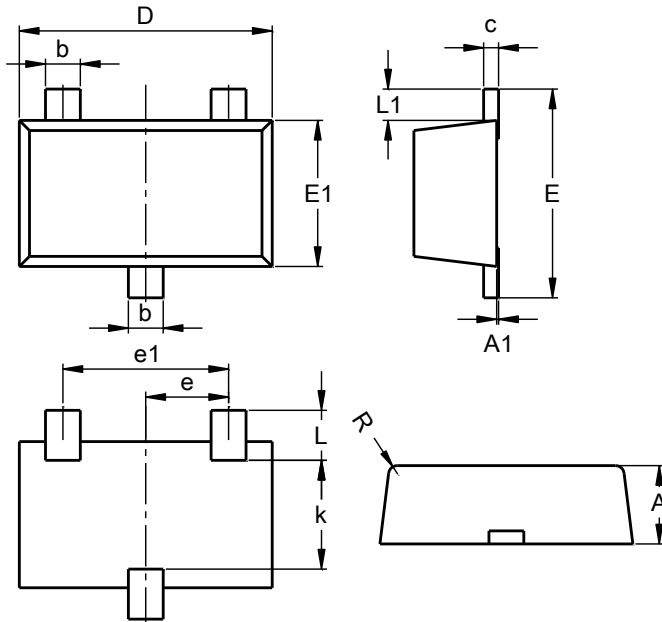

SOT23F			
Dim	Min	Max	Typ
A	0.80	1.00	0.90
A1	0.00	0.10	0.01
b	0.35	0.50	0.44
c	0.10	0.20	0.16
D	2.80	3.00	2.90
e	0.95 REF		
e1	1.90 REF		
E	2.30	2.50	2.40
E1	1.50	1.70	1.65
k	1.20	-	-
L	0.30	0.65	0.50
L1	0.30	0.50	0.40
R	0.05	0.15	-
All Dimensions in mm			

Suggested Pad Layout

Please see <http://www.diodes.com/package-outlines.html> for the latest version.

SOT23F

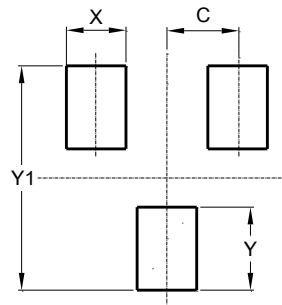

Dimensions	Value (in mm)
C	0.95
X	0.80
Y	1.110
Y1	3.000

IMPORTANT NOTICE

1. DIODES INCORPORATED (Diodes) AND ITS SUBSIDIARIES MAKE NO WARRANTY OF ANY KIND, EXPRESS OR IMPLIED, WITH REGARDS TO ANY INFORMATION CONTAINED IN THIS DOCUMENT, INCLUDING, BUT NOT LIMITED TO, THE IMPLIED WARRANTIES OF MERCHANTABILITY, FITNESS FOR A PARTICULAR PURPOSE OR NON-INFRINGEMENT OF THIRD PARTY INTELLECTUAL PROPERTY RIGHTS (AND THEIR EQUIVALENTS UNDER THE LAWS OF ANY JURISDICTION).
2. The Information contained herein is for informational purpose only and is provided only to illustrate the operation of Diodes' products described herein and application examples. Diodes does not assume any liability arising out of the application or use of this document or any product described herein. This document is intended for skilled and technically trained engineering customers and users who design with Diodes' products. Diodes' products may be used to facilitate safety-related applications; however, in all instances customers and users are responsible for (a) selecting the appropriate Diodes products for their applications, (b) evaluating the suitability of Diodes' products for their intended applications, (c) ensuring their applications, which incorporate Diodes' products, comply the applicable legal and regulatory requirements as well as safety and functional-safety related standards, and (d) ensuring they design with appropriate safeguards (including testing, validation, quality control techniques, redundancy, malfunction prevention, and appropriate treatment for aging degradation) to minimize the risks associated with their applications.
3. Diodes assumes no liability for any application-related information, support, assistance or feedback that may be provided by Diodes from time to time. Any customer or user of this document or products described herein will assume all risks and liabilities associated with such use, and will hold Diodes and all companies whose products are represented herein or on Diodes' websites, harmless against all damages and liabilities.
4. Products described herein may be covered by one or more United States, international or foreign patents and pending patent applications. Product names and markings noted herein may also be covered by one or more United States, international or foreign trademarks and trademark applications. Diodes does not convey any license under any of its intellectual property rights or the rights of any third parties (including third parties whose products and services may be described in this document or on Diodes' website) under this document.
5. Diodes' products are provided subject to Diodes' Standard Terms and Conditions of Sale (<https://www.diodes.com/about/company/terms-and-conditions/terms-and-conditions-of-sales/>) or other applicable terms. This document does not alter or expand the applicable warranties provided by Diodes. Diodes does not warrant or accept any liability whatsoever in respect of any products purchased through unauthorized sales channel.
6. Diodes' products and technology may not be used for or incorporated into any products or systems whose manufacture, use or sale is prohibited under any applicable laws and regulations. Should customers or users use Diodes' products in contravention of any applicable laws or regulations, or for any unintended or unauthorized application, customers and users will (a) be solely responsible for any damages, losses or penalties arising in connection therewith or as a result thereof, and (b) indemnify and hold Diodes and its representatives and agents harmless against any and all claims, damages, expenses, and attorney fees arising out of, directly or indirectly, any claim relating to any noncompliance with the applicable laws and regulations, as well as any unintended or unauthorized application.
7. While efforts have been made to ensure the information contained in this document is accurate, complete and current, it may contain technical inaccuracies, omissions and typographical errors. Diodes does not warrant that information contained in this document is error-free and Diodes is under no obligation to update or otherwise correct this information. Notwithstanding the foregoing, Diodes reserves the right to make modifications, enhancements, improvements, corrections or other changes without further notice to this document and any product described herein. This document is written in English but may be translated into multiple languages for reference. Only the English version of this document is the final and determinative format released by Diodes.
8. Any unauthorized copying, modification, distribution, transmission, display or other use of this document (or any portion hereof) is prohibited. Diodes assumes no responsibility for any losses incurred by the customers or users or any third parties arising from any such unauthorized use.
9. This Notice may be periodically updated with the most recent version available at <https://www.diodes.com/about/company/terms-and-conditions/important-notice>

DIODES is a trademark of Diodes Incorporated in the United States and other countries.
The Diodes logo is a registered trademark of Diodes Incorporated in the United States and other countries.
© 2022 Diodes Incorporated. All Rights Reserved.

www.diodes.com

X-ON Electronics

Largest Supplier of Electrical and Electronic Components

Click to view similar products for [Diodes Incorporated](#) manufacturer:

Other Similar products are found below :

[004419CB](#) [069117AB](#) [1.5KE15A-T](#) [1.5KE15CA-T](#) [1.5KE200A-T](#) [1.5KE20CA-T](#) [1.5KE24A-T](#) [1.5KE27CA-T](#) [1.5KE30A-T](#) [1.5KE30CA-T](#)
[1.5KE33A-T](#) [1.5KE350A-T](#) [1.5KE36CA-T](#) [1.5KE47A-T](#) [1.5KE47CA-T](#) [1.5KE51CA-T](#) [1.5KE62A-T](#) [1.5KE68A-T](#) [1.5KE68CA](#)
[1.5KE6V8CA-T](#) [1.5KE7V5A-T](#) [1.5KE82CA-T](#) [1.5KE9V1A-T](#) [1N4001G-T](#) [1N4001-T](#) [1N4002](#) [1N4002G-T](#) [1N4002-T](#) [1N4003G-T](#)
[1N4003-T](#) [1N4004](#) [1N4004G-T](#) [1N4004-T](#) [1N4005-B](#) [1N4005G-T](#) [1N4005-T](#) [1N4005-TR](#) [1N4006-B](#) [1N4006G-T](#) [1N4006-T](#) [1N4007G-T](#)
[1N4007-T](#) [1N4148-T](#) [1N4148W-13-F](#) [1N4148W-7-F](#) [1N4148WQ-13-F](#) [1N4148WQ-7-F](#) [1N4148WS-13-F](#) [1N4148WS-7-F](#) [1N4148WSF-7](#)