

## Product Summary

- Continuous Drain-Source Voltage: 60V
- On-State Resistance: 200mΩ
- Nominal Load Current ( $V_{IN} = 5V$ ): 1.8A
- Clamping Energy: 120mJ

## Description

The ZXMS6005DN8Q is a dual self-protected low side IntelliFET™ MOSFET with logic level input. It integrates overtemperature, overcurrent, overvoltage (active clamp) and ESD protected logic level functionality. The ZXMS6005DN8Q is ideal as a general purpose switch driven from 3.3V or 5V microcontrollers in harsh environments where standard MOSFETs are not rugged enough.

## Applications

- Lamp Driver
- Motor Driver
- Relay Driver
- Solenoid Driver

## Features and Benefits

- Low Input Current
- Logic Level Input (3.3V and 5V)
- Short Circuit Protection with Auto Restart
- Overvoltage Protection (Active Clamp)
- Thermal Shutdown with Auto Restart
- Overcurrent Protection
- Input Protection (ESD)
- High Continuous Current Rating
- **Totally Lead-Free & Fully RoHS Compliant (Notes 1 & 2)**
- **Halogen and Antimony Free. "Green" Device (Note 3)**
- **Qualified to AEC-Q101 Standards for High Reliability**
- **PPAP Capable (Note 4)**

## Mechanical Data

- Case: SO-8
- Case Material: Molded Plastic, "Green" Molding Compound. UL Flammability Classification Rating 94V-0
- Moisture Sensitivity: Level 1 per J-STD-020
- Terminals: Matte Tin Finish<sup>(3)</sup>
- Weight: 79.1mg (Approximate)

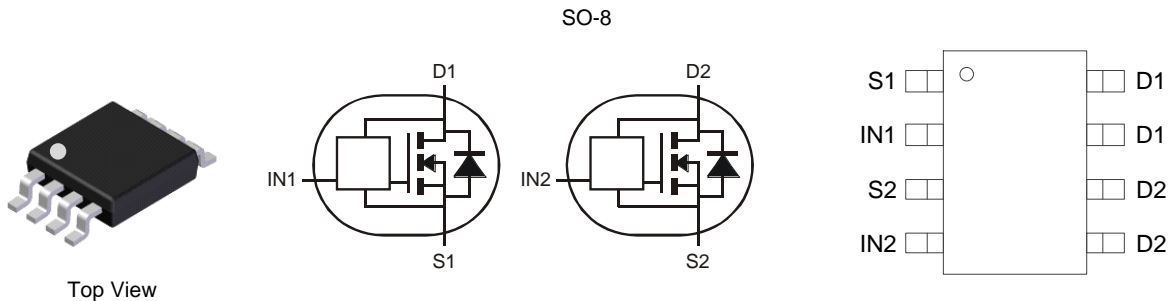

## Ordering Information (Note 5)

| Part Number     | Marking | Reel Size (inches) | Tape Width (mm) | Quantity per Reel |
|-----------------|---------|--------------------|-----------------|-------------------|
| ZXMS6005DN8Q-13 | 6005DN8 | 13                 | 12              | 2,500 units       |

- Notes:
1. No purposely added lead. Fully EU Directive 2002/95/EC (RoHS) & 2011/65/EU.
  2. See [http://www.diodes.com/quality/lead\\_free.html](http://www.diodes.com/quality/lead_free.html) for more information about Diodes Incorporated's definitions of Halogen- and Antimony-free, "Green" and Lead-free.
  3. Halogen- and Antimony-free "Green" products are defined as those which contain <900ppm bromine, <900ppm chlorine (<1500ppm total Br + Cl) and <1000ppm antimony compounds.
  4. Automotive products are AEC-Q101 qualified and are PPAP capable. Refer to [http://www.diodes.com/product\\_compliance\\_definitions.html](http://www.diodes.com/product_compliance_definitions.html).
  5. For packaging details, go to our website at <https://www.diodes.com/design/support/packaging/diodes-packaging/>.

## Marking Information

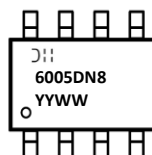

ⓁⓂⓂ = Manufacturer's Marking  
 6005DN8 = Product Type Marking Code  
 YYWW = Date Code Marking  
 YY: Year  
 WW: Week: 01~52;  
 52 Represents 52 and 53 Week

## Functional Block Diagram

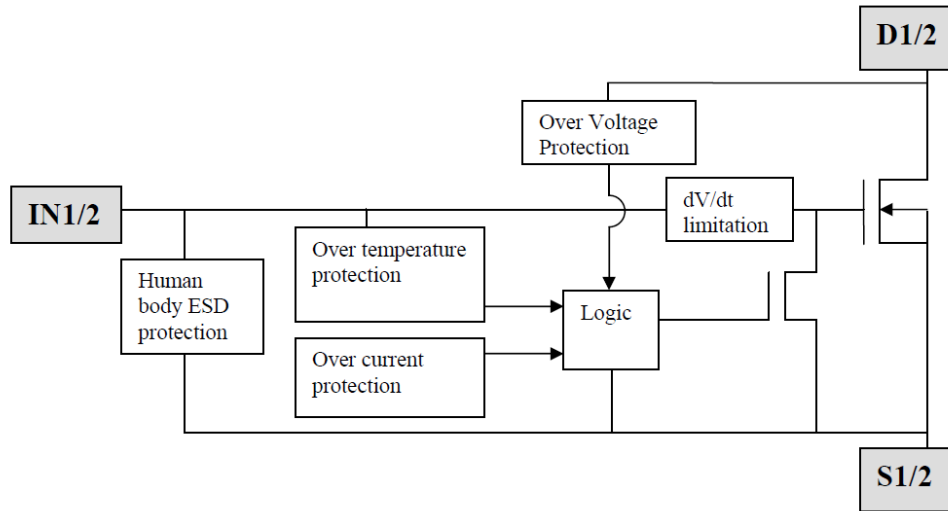

## Application Information

- Two Completely Isolated Independent Channels
- Especially Suited for Loads with a High In-rush Current Such as Lamps and Motors
- All Types of Resistive, Inductive and Capacitive Loads in Switching Applications
- $\mu\text{C}$  Compatible Power Switch for 12V and 24V DC Applications
- Replaces Electromechanical Relays and Discrete Circuits
- Linear Mode Capability — the current-limiting protection circuitry is designed to deactivate at low  $V_{\text{DS}}$  to minimize on-state power dissipation. The maximum DC operating current is therefore determined by the thermal capability of the package or board combination, rather than by the protection circuitry. This does not compromise the product's ability to self-protect at low  $V_{\text{DS}}$ .

## Absolute Maximum Ratings (@ $T_A = +25^\circ\text{C}$ , unless otherwise stated.)

| Characteristic  | Symbol              | Value                    | Unit |
|---|---------------------|--------------------------|------|
| Continuous Drain-Source Voltage   | $V_{\text{DS}}$     | 60                       | V    |
| Drain-Source Voltage For Short Circuit Protection   | $V_{\text{DS(SC)}}$ | 16                       | V    |
| Continuous Input Voltage  | $V_{\text{IN}}$     | -0.5 to +6               | V    |
| Continuous Input Current @ $-0.2\text{V} \leq V_{\text{IN}} \leq 6\text{V}$   | $I_{\text{IN}}$     | No Limit                 | mA   |
| Continuous Input Current @ $V_{\text{IN}} < -0.2\text{V}$ or $V_{\text{IN}} > 6\text{V}$  |                     | $ I_{\text{IN}}  \leq 2$ |      |
| Pulsed Drain Current @ $V_{\text{IN}} = 3.3\text{V}$  | $I_{\text{DM}}$     | 5                        | A    |
| Pulsed Drain Current @ $V_{\text{IN}} = 5\text{V}$  | $I_{\text{DM}}$     | 6                        | A    |
| Continuous Source Current (Body Diode) (Note 6)   | $I_{\text{S}}$      | 2.5                      | A    |
| Pulsed Source Current (Body Diode)  | $I_{\text{SM}}$     | 10                       | A    |
| Unclamped Single Pulse Inductive Energy,<br>$T_J = +25^\circ\text{C}$ , $I_{\text{D}} = 0.5\text{A}$ , $V_{\text{DD}} = 24\text{V}$ | $E_{\text{AS}}$     | 120                      | mJ   |
| Electrostatic Discharge (Human Body Model)  | $V_{\text{HBM}}$    | 4,000                    | V    |
| Charged Device Model  | $V_{\text{CDM}}$    | 1,000                    | V    |

Note: 6. Device mounted on FR-4 substrate PC board, 2oz copper, with minimum recommended pad layout.

## Recommended Operating Conditions

The ZXMS6005DN8Q is optimized for use with  $\mu\text{C}$  operating from 3.3V and 5V supplies.

| Characteristic  | Symbol   | Min | Max  | Unit               |
|---|----------|-----|------|--------------------|
| Input Voltage Range   | $V_{IN}$ | 0   | 5.5  | V                  |
| Ambient Temperature Range                                     | $T_A$    | -40 | +125 | $^{\circ}\text{C}$ |
| High Level Input Voltage for MOSFET to be On                  | $V_{IH}$ | 3   | 5.5  | V                  |
| Low Level Input Voltage for MOSFET to be Off                  | $V_{IL}$ | 0   | 0.7  | V                  |
| Peripheral Supply Voltage (Voltage to which load is referred) | $V_P$    | 0   | 16   | V                  |

## Thermal Characteristics

| Characteristic  | Symbol          | Value       | Unit                         |
|---|-----------------|-------------|------------------------------|
| Power Dissipation at $T_A = +25^{\circ}\text{C}$ (Note 6) | $P_D$           | 1.21        | W                            |
| Linear Derating Factor                                    |                 | 9.7         | $\text{mW}/^{\circ}\text{C}$ |
| Power Dissipation at $T_A = +25^{\circ}\text{C}$ (Note 7) | $P_D$           | 1.56        | W                            |
| Linear Derating Factor                                    |                 | 12.5        | $\text{mW}/^{\circ}\text{C}$ |
| Thermal Resistance, Junction to Ambient (Note 6)          | $R_{\theta JA}$ | 103         | $^{\circ}\text{C}/\text{W}$  |
| Thermal Resistance, Junction to Ambient (Note 7)          | $R_{\theta JA}$ | 81          | $^{\circ}\text{C}/\text{W}$  |
| Thermal Resistance, Junction to Case (Note 8)             | $R_{\theta JC}$ | 13.5        | $^{\circ}\text{C}/\text{W}$  |
| Operating Temperature Range                               | $T_J$           | -40 to +150 | $^{\circ}\text{C}$           |
| Storage Temperature Range                                 | $T_{STG}$       | -55 to +150 | $^{\circ}\text{C}$           |

Notes: 7. Device mounted on FR-4 substrate PC board, 2oz copper, with 1-inch square copper plate.  
8. Thermal resistance between junction and the mounting surfaces of drain and source pins.

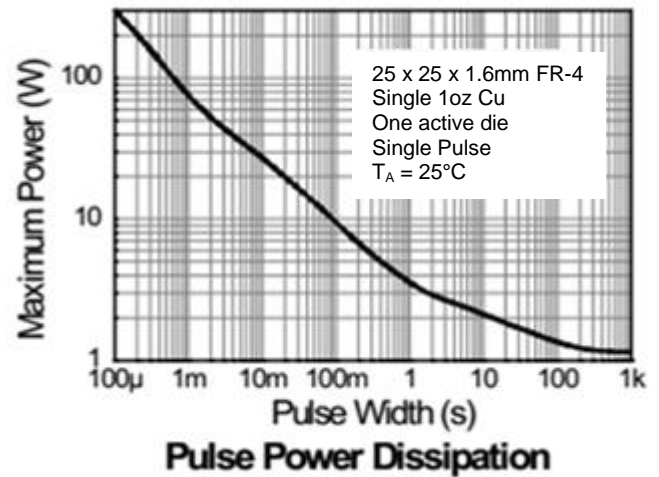
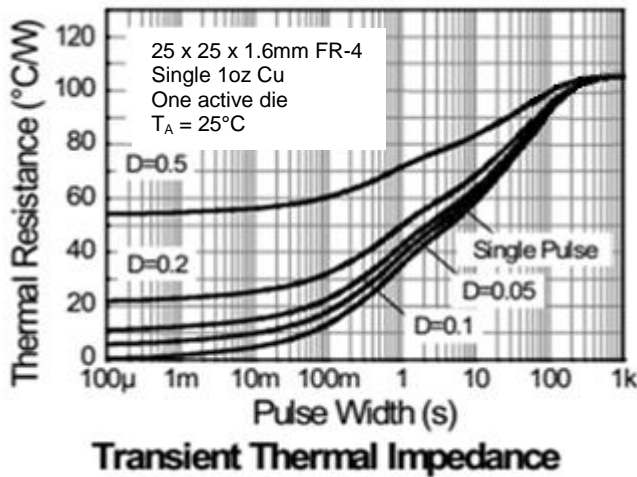
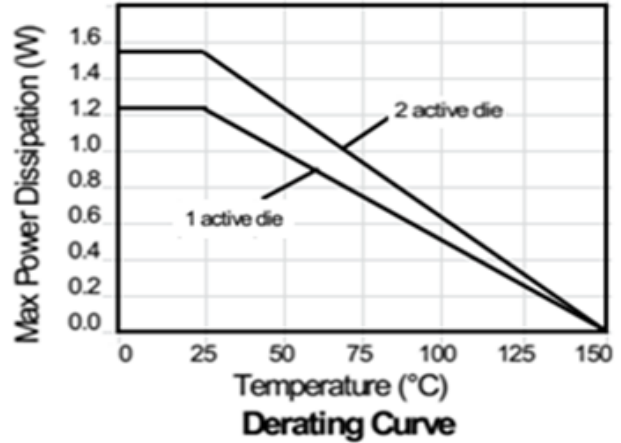
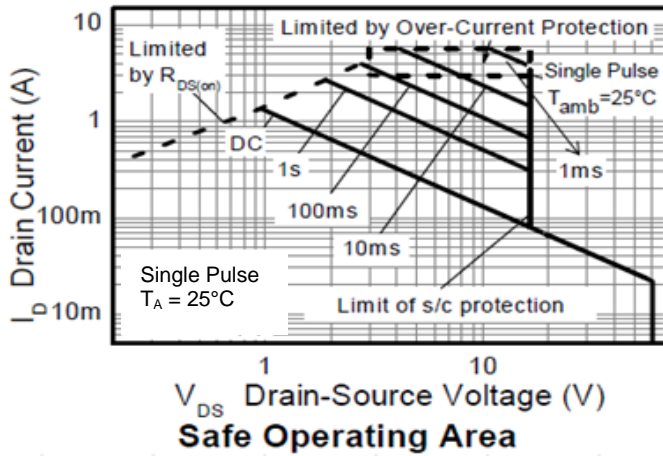

**Electrical Characteristics** (@T<sub>A</sub> = +25°C, unless otherwise specified.)

| Characteristic                              | Symbol              | Min  | Typ  | Max | Unit | Test Condition   |
|---|---------------------|------|------|-----|------|--|
| <b>Static Characteristics</b>               |                     |      |      |     |      |  |
| Drain-Source Clamp Voltage                  | V <sub>DS(AZ)</sub> | 60   | 65   | 70  | V    | I <sub>D</sub> = 10mA  |
| Off-State Drain Current                     | I <sub>DSS</sub>    | —    | —    | 1   | μA   | V <sub>DS</sub> = 12V, V <sub>IN</sub> = 0V                        |
|   |                     | —    | —    | 2   |      | V <sub>DS</sub> = 36V, V <sub>IN</sub> = 0V                        |
| Input Threshold Voltage                     | V <sub>IN(TH)</sub> | 0.7  | 1    | 1.5 | V    | V <sub>DS</sub> = V <sub>GS</sub> , I <sub>D</sub> = 1mA           |
| Input Current                               | I <sub>IN</sub>     | —    | 60   | 100 | μA   | V <sub>IN</sub> = 3V   |
|   |                     | —    | 120  | 200 |      | V <sub>IN</sub> = 5V   |
| Input Current while Over-Temperature Active | —                   | —    | —    | 300 | μA   | V <sub>IN</sub> = 5V   |
| Static Drain-Source On-State Resistance     | R <sub>DS(ON)</sub> | —    | 170  | 250 | mΩ   | V <sub>IN</sub> = 3V, I <sub>D</sub> = 1A                          |
|   |                     | —    | 150  | 200 |      | V <sub>IN</sub> = 5V, I <sub>D</sub> = 1A                          |
| Continuous Drain Current (Note 6)           | I <sub>D</sub>      | 1.4  | —    | —   | A    | V <sub>IN</sub> = 3V; T <sub>A</sub> = +25°C                       |
|   |                     | 1.6  | —    | —   |      | V <sub>IN</sub> = 5V; T <sub>A</sub> = +25°C                       |
| Continuous Drain Current (Note 7)           |                     | 1.7  | —    | —   |      | V <sub>IN</sub> = 3V; T <sub>A</sub> = +25°C                       |
|   |                     | 1.8  | —    | —   |      | V <sub>IN</sub> = 5V; T <sub>A</sub> = +25°C                       |
| Current Limit (Note 9)                      | I <sub>D(LIM)</sub> | 2.2  | 5    | —   | A    | V <sub>IN</sub> = 3V   |
|   |                     | 3.3  | 7    | —   |      | V <sub>IN</sub> = 5V   |
| <b>Dynamic Characteristics</b>              |                     |      |      |     |      |  |
| Turn On Delay Time                          | t <sub>D(ON)</sub>  | —    | 6    | —   | μs   | V <sub>DD</sub> = 12V, I <sub>D</sub> = 0.5A, V <sub>GS</sub> = 5V |
| Rise Time                                   | t <sub>R</sub>      | —    | 14   | —   | μs   |  |
| Turn Off Delay Time                         | t <sub>D(OFF)</sub> | —    | 34   | —   | μs   |  |
| Fall Time                                   | t <sub>F</sub>      | —    | 19   | —   | μs   |  |
| <b>Over-Temperature Protection</b>          |                     |      |      |     |      |  |
| Thermal Overload Trip Temperature (Note 10) | T <sub>JT</sub>     | +150 | +175 | —   | °C   | —  |
| Thermal Hysteresis (Note 10)                | ΔT <sub>JT</sub>    | —    | +10  | —   | °C   | —  |

- Notes:
- The drain current is restricted only when the device is in saturation (see graph "Typical Output Characteristic"). This allows the device to be used in the onstate without interference from the current limit. The device is fully protected at all drain currents, as the low power dissipation generated outside saturation makes current limit unnecessary.
  - Over-temperature protection is designed to prevent device destruction under fault conditions. Fault conditions are considered as "outside" normal operating range, so this part is not designed to withstand over-temperature for extended periods.

**Typical Characteristics**

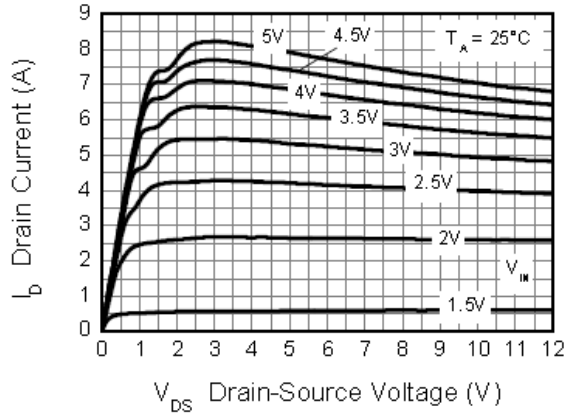

**Typical Output Characteristic**

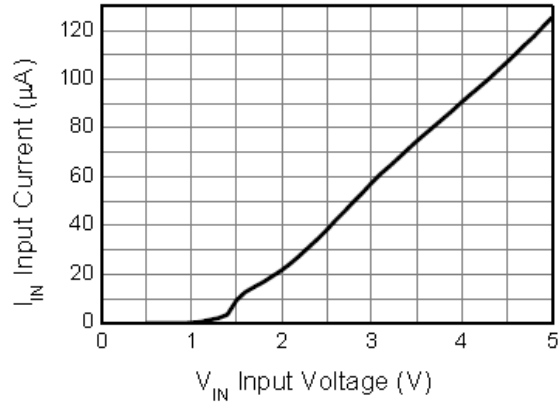

**Input Current vs Input Voltage**

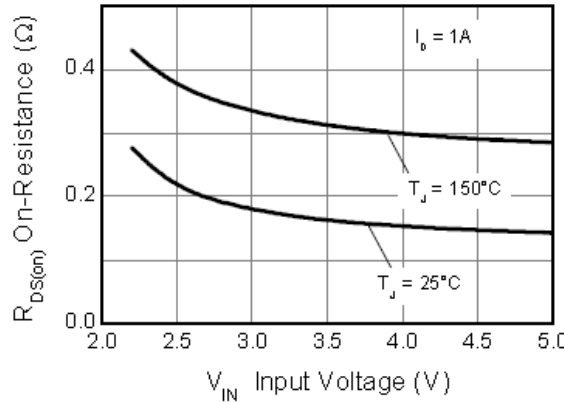

**On-Resistance vs Input Voltage**

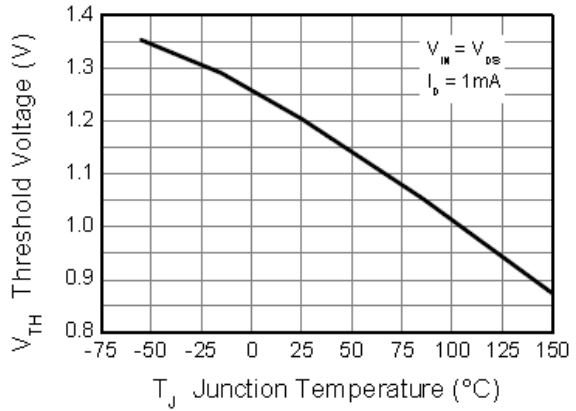

**Threshold Voltage vs Temperature**

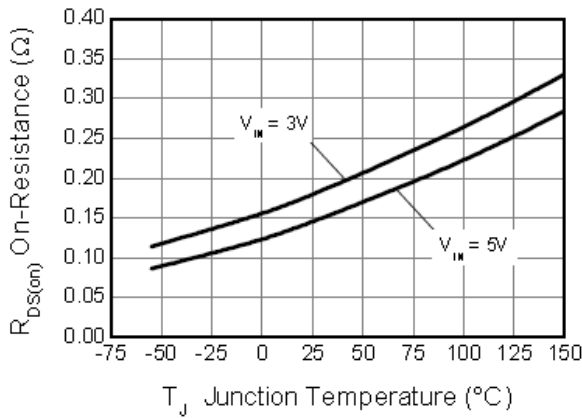

**On-Resistance vs Temperature**

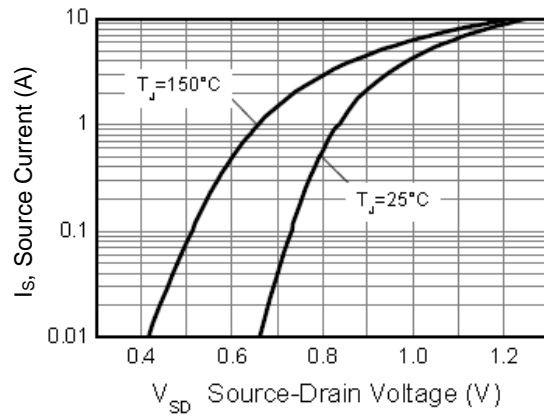

**Reverse Diode Characteristic**

**Typical Characteristics (Cont.)**

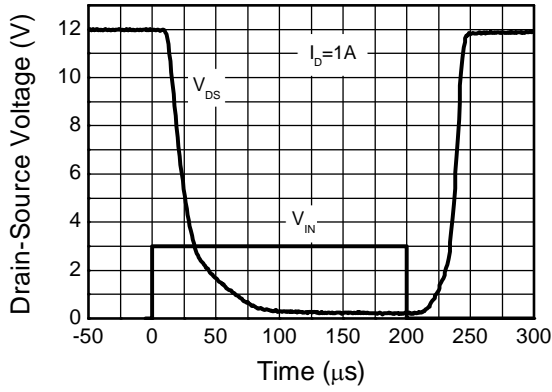

**Switching Speed**

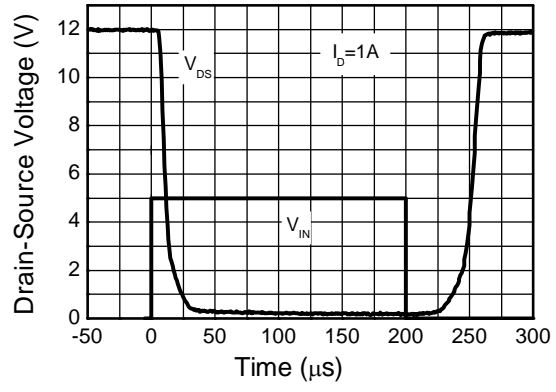

**Switching Speed**

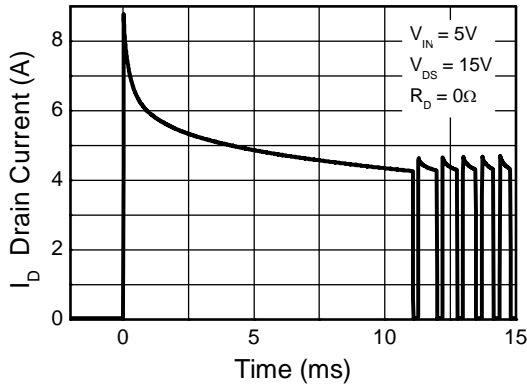

**Typical Short Circuit Protection**

**Package Outline Dimensions**

Please see <http://www.diodes.com/package-outlines.html> for the latest version.

SO-8

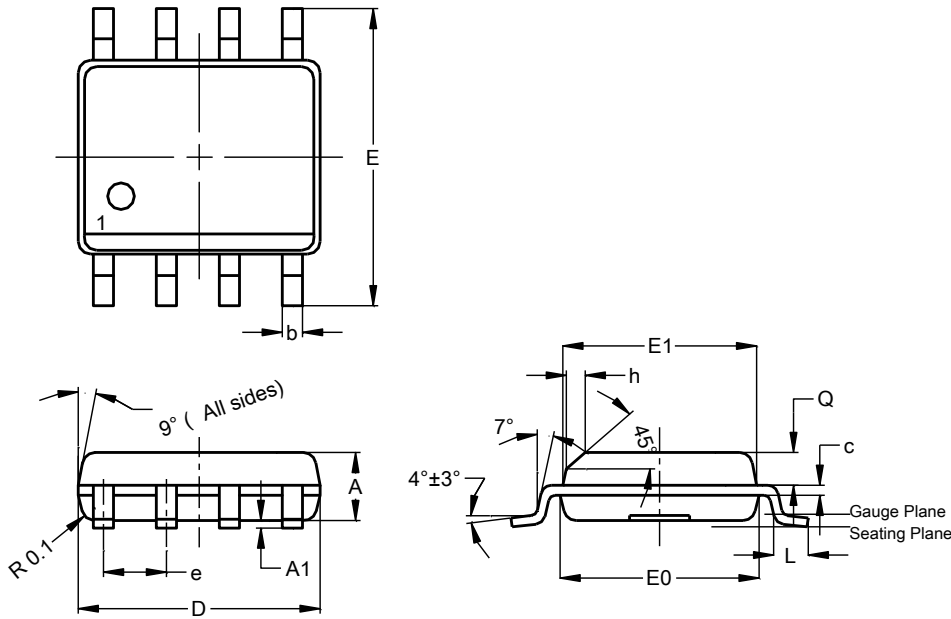

| SO-8                 |      |      |      |
|----------------------|------|------|------|
| Dim                  | Min  | Max  | Typ  |
| A                    | 1.40 | 1.50 | 1.45 |
| A1                   | 0.10 | 0.20 | 0.15 |
| b                    | 0.30 | 0.50 | 0.40 |
| c                    | 0.15 | 0.25 | 0.20 |
| D                    | 4.85 | 4.95 | 4.90 |
| E                    | 5.90 | 6.10 | 6.00 |
| E1                   | 3.80 | 3.90 | 3.85 |
| E0                   | 3.85 | 3.95 | 3.90 |
| e                    | --   | --   | 1.27 |
| h                    | -    | --   | 0.35 |
| L                    | 0.62 | 0.82 | 0.72 |
| Q                    | 0.60 | 0.70 | 0.65 |
| All Dimensions in mm |      |      |      |

**Suggested Pad Layout**

Please see <http://www.diodes.com/package-outlines.html> for the latest version.

SO-8

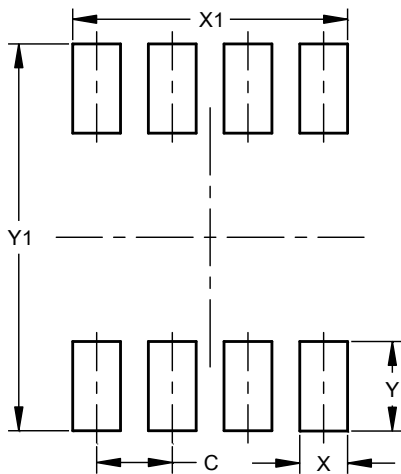

| Dimensions | Value (in mm) |
|------------|---------------|
| C          | 1.27          |
| X          | 0.802         |
| X1         | 4.612         |
| Y          | 1.505         |
| Y1         | 6.50          |

**IMPORTANT NOTICE**

DIODES INCORPORATED MAKES NO WARRANTY OF ANY KIND, EXPRESS OR IMPLIED, WITH REGARDS TO THIS DOCUMENT, INCLUDING, BUT NOT LIMITED TO, THE IMPLIED WARRANTIES OF MERCHANTABILITY AND FITNESS FOR A PARTICULAR PURPOSE (AND THEIR EQUIVALENTS UNDER THE LAWS OF ANY JURISDICTION).

Diodes Incorporated and its subsidiaries reserve the right to make modifications, enhancements, improvements, corrections or other changes without further notice to this document and any product described herein. Diodes Incorporated does not assume any liability arising out of the application or use of this document or any product described herein; neither does Diodes Incorporated convey any license under its patent or trademark rights, nor the rights of others. Any Customer or user of this document or products described herein in such applications shall assume all risks of such use and will agree to hold Diodes Incorporated and all the companies whose products are represented on Diodes Incorporated website, harmless against all damages.

Diodes Incorporated does not warrant or accept any liability whatsoever in respect of any products purchased through unauthorized sales channel. Should Customers purchase or use Diodes Incorporated products for any unintended or unauthorized application, Customers shall indemnify and hold Diodes Incorporated and its representatives harmless against all claims, damages, expenses, and attorney fees arising out of, directly or indirectly, any claim of personal injury or death associated with such unintended or unauthorized application.

Products described herein may be covered by one or more United States, international or foreign patents pending. Product names and markings noted herein may also be covered by one or more United States, international or foreign trademarks.

This document is written in English but may be translated into multiple languages for reference. Only the English version of this document is the final and determinative format released by Diodes Incorporated.

**LIFE SUPPORT**

Diodes Incorporated products are specifically not authorized for use as critical components in life support devices or systems without the express written approval of the Chief Executive Officer of Diodes Incorporated. As used herein:

A. Life support devices or systems are devices or systems which:

1. are intended to implant into the body, or
2. support or sustain life and whose failure to perform when properly used in accordance with instructions for use provided in the labeling can be reasonably expected to result in significant injury to the user.

B. A critical component is any component in a life support device or system whose failure to perform can be reasonably expected to cause the failure of the life support device or to affect its safety or effectiveness.

Customers represent that they have all necessary expertise in the safety and regulatory ramifications of their life support devices or systems, and acknowledge and agree that they are solely responsible for all legal, regulatory and safety-related requirements concerning their products and any use of Diodes Incorporated products in such safety-critical, life support devices or systems, notwithstanding any devices- or systems-related information or support that may be provided by Diodes Incorporated. Further, Customers must fully indemnify Diodes Incorporated and its representatives against any damages arising out of the use of Diodes Incorporated products in such safety-critical, life support devices or systems.

Copyright © 2017, Diodes Incorporated

[www.diodes.com](http://www.diodes.com)



## X-ON Electronics

Largest Supplier of Electrical and Electronic Components

*Click to view similar products for [MOSFET](#) category:*

*Click to view products by [Diodes Incorporated](#) manufacturer:*

Other Similar products are found below :

[614233C](#) [648584F](#) [IRFD120](#) [JANTX2N5237](#) [FCA20N60\\_F109](#) [FDZ595PZ](#) [2SK2545\(Q,T\)](#) [405094E](#) [423220D](#) [TPCC8103,L1Q\(CM](#)  
[MIC4420CM-TR](#) [VN1206L](#) [614234A](#) [715780A](#) [NTNS3166NZT5G](#) [SSM6J414TU,LF\(T](#) [751625C](#) [BUK954R8-60E](#) [GROUP A 5962-](#)  
[8877003PA](#) [NTE6400](#) [SQJ402EP-T1-GE3](#) [2SK2614\(TE16L1,Q\)](#) [2N7002KW-FAI](#) [DMN1017UCP3-7](#) [EFC2J004NUZTDG](#) [ECH8691-TL-W](#)  
[FCAB21350L1](#) [P85W28HP2F-7071](#) [DMN1053UCP4-7](#) [NTE221](#) [NTE222](#) [NTE2384](#) [NTE2903](#) [NTE2941](#) [NTE2945](#) [NTE2946](#) [NTE2960](#)  
[NTE2967](#) [NTE2969](#) [NTE2976](#) [NTE2994](#) [NTE6400A](#) [NTE2910](#) [NTE2916](#) [NTE2956](#) [NTE2939](#) [NTE2911](#) [DMN2080UCB4-7](#)  
[TK10A80W,S4X\(S](#) [STF35N65DM2](#)