

DIA2641

Low Power, High Speed, Rail-to-Rail Input and Output CMOS Amplifiers

Description

The DIA2641 is an amplifier with high supply voltage, low noise, low power consumption. The DIA2641 has a high gain-bandwidth product (GBWP) of 95 MHz and exceptionally high output current (approximately 60 mA) at low cost and with reduced power consumption when compared to existing devices with similar performance.

The DIA2641 is designed to provide optimal performance in low noise or even low voltage systems. This chip provides rail-to-rail output swing into heavy loads. Fast output slew rate ensures large peak-to-peak output swings can be maintained even at higher speeds.

It is specified over the extended industrial temperature range (-40°C to 125 °C). The operating range is from 2.7 V to 13.2 V.

Features

- AEC-Q100 qualified with the following results:
 - Device temperature grade 1: -40°C to 125°C
 - Moisture sensitivity level 1
 - HBM ESD level H3A
 - CDM ESD level C3
- Rail-to-rail input, and rail-to-rail output
- Supply voltage range: 2.7 V to 13.2 V
- Supply current (no load): 7 mA
- Low offset voltage: 13 mV (max)
- Output voltage swing 20 mV from rails
- High gain-bandwidth product: 95 MHz when $V_S = 5\text{ V}$
- Slew rate ($A_V = -1$): 70 V/ μs when $V_S = 3\text{ V}$, 125 V/ μs when $V_S = 5\text{ V}, 10\text{ V}$
- Settling time: 100 ns
- Input voltage noise (100 kHz): 40 nV/ $\sqrt{\text{Hz}}$
- Output short protection
- Available package: SOT23-5

Applications

- Automotive lightings
- Body electronics
- Automotive head units
- Telematics control units
- Emergency call (eCall)
- Passive safety: brake systems

Ordering Information

Part No.	Top Marking	RoHS	T _A	Package	
DIA2641ST5	YWFDA	Green	-40 to 125°C	SOT23-5	Tape & Reel,3000

If you encounter any issue in the process of using the device, please contact our customer service at marketing@dioo.com or phone us at (+86)-21-62116882. If you have any improvement suggestions regarding the datasheet, we encourage you to contact our technical writing team at docs@dioo.com. Your feedback is invaluable for us to provide a better user experience.

Table of Contents

1. Pin Assignment and Functions	1
2. Absolute Maximum Ratings	1
3. Recommended Operating Condition	2
4. ESD Ratings	2
5. Electrical Characteristics	3
5.1. 3 V Electrical characteristics	3
5.2. 5 V Electrical Characteristics	4
5.3. 10 V Electrical Characteristics	5
6. Typical Characteristics	6
7. Feature Description	8
8. Typical Applications	9
9. Physical Dimensions: SOT23-5	10

List of Figures

Figure 1 . Closed loop gain vs. frequency for various gain	6
Figure 2 . Closed loop gain vs. frequency for various gain	6
Figure 3 . Closed loop gain vs. frequency for various gain	6
Figure 4 . Closed loop frequency response for various supplies	6
Figure 5 . Closed loop frequency response for various supplies	6
Figure 6 . Large signal frequency response	6
Figure 7 . PSRR vs. frequency	7
Figure 8 . CMRR vs. frequency	7
Figure 9 . Small signal step response	7
Figure 10 . Small signal step response	7
Figure 11 . Large signal step response	7
Figure 12 . Large signal step response	7
Figure 13 . Typical application: gain = -1	9
Figure 14 . Typical application: gain = 2	9
Figure 15 . Amplifier with bypass capacitors	9

1. Pin Assignment and Functions

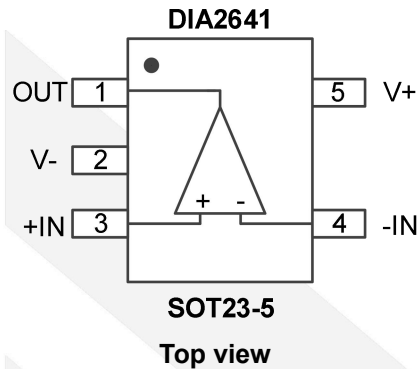

Pin No.	Name	Description
1	OUT	Output
2	V-	Negative supply
3	+IN	Positive Input
4	-IN	Negative Input
5	V+	Positive supply

2. Absolute Maximum Ratings

Exceeding the maximum ratings listed under Absolute Maximum Ratings when designing is likely to damage the device permanently. Do not design to the maximum limits because long-time exposure to them might impact the device's reliability. The ratings are obtained over an operating free-air temperature range unless otherwise specified.

Symbol	Parameter	Ratings	Unit
V_S	Supply voltage	13.5	V
V_{IN}	Input voltage	$(V_-)-0.5$ to $(V_+)+0.5$	V
T_{STG}	Storage temperature range	-65 to 150	°C
T_J	Junction temperature	150	°C
T_L	Lead temperature range	260	°C
	Latch up	200	mA

3. Recommended Operating Condition

Recommended operating conditions are specified to ensure optimal performance to the datasheet specifications. The ratings are obtained over an operating free-air temperature range unless otherwise specified.

Symbol	Parameter	Ratings	Unit
V _S	Supply voltage	2.7 to 13.2	V
T _A	Operating temperature range	-40 to 125	°C

4. ESD Ratings

When a statically-charged person or object touches an electrostatic discharge sensitive device, the electrostatic charge might be drained through sensitive circuitry in the device. If the electrostatic discharge possesses sufficient energy, damage might occur to the device due to localized overheating.

Parameter	Standard	Value	Unit
Electrostatic discharge	Human-body model (HBM), per AEC Q100-002, all pins	±8000	V
	Charged device model (CDM), per AEC Q100-01, all pins	±2000	V

5. Electrical Characteristics

5.1. 3 V Electrical characteristics

The typical values are obtained under these conditions unless otherwise specified: $T_A = 25^\circ\text{C}$, $V_+ = 3\text{ V}$, $V_- = 0\text{ V}$, $V_{\text{CM}} = V_+/2$, $R_L = 2\text{ k}\Omega$ to $V_+/2$

Symbol	Parameter	Conditions	Min	Typ	Max	Unit
--------	-----------	------------	-----	-----	-----	------

Power supply

PSRR	Power supply rejection ratio	$V_+ = 3.0\text{ V}$ to 3.5 V , $V_{\text{CM}} = 1.5\text{ V}$		90		dB
I_s	Supply current	No load		7		mA

Input

V_{OS}	Input offset voltage				± 13	mV
V_{CM}	Input common mode voltage range	Low rail		0		V
		High rail		3		
CMRR	Common mode rejection ratio	V_{CM} stepped from 0 V to 1.5 V		80		dB
A_v	Open loop voltage gain	$R_L = 2\text{ k}\Omega$ to $V_+/2$		101		dB
$\Delta V_{\text{OS}}/\Delta T$	Input offset average drift	Offset voltage average drift determined by dividing the change in V_{OS} at temperature extremes by the total temperature change.		± 20		$\mu\text{V}/^\circ\text{C}$

Output

I_{SC}	Output short circuit current	Sourcing to V_-		60		mA
		Sinking from V_+		70		mA
I_{OUT}	Output current	$V_{\text{OUT}} = 0.5\text{ V}$ from V_+		38		mA
		$V_{\text{OUT}} = 0.5\text{ V}$ from V_-		36		mA
V_{OUT}	Output swing high	$R_L = 2\text{ k}\Omega$ to $V_+/2$	2.98	2.985		V
	Output swing low	$R_L = 2\text{ k}\Omega$ to $V_+/2$			15	mV

Dynamic performance

BW	-3 dB bandwidth	$A_v = +1$, $V_{\text{OUT}} = 200\text{ mV}_{\text{PP}}$		78		MHz
		$A_v = +2$, $V_{\text{OUT}} = 200\text{ mV}_{\text{PP}}$		55		MHz
		$A_v = -1$, $V_{\text{OUT}} = 200\text{ mV}_{\text{PP}}$		36		MHz
SR	Slew rate	$A_v = -1$, $V_{\text{IN}} = 2\text{ V}_{\text{PP}}$		80		$\text{V}/\mu\text{s}$
t_s	Settling time	$V_{\text{OUT}} = 2\text{ V}_{\text{PP}}$, $\pm 1\%$, 8 pF load, $V_s = 5\text{ V}$		100		ns

Noise performance

THD	Total harmonic distortion	$f = 1\text{ kHz}$, $V_o = 2\text{ V}_{\text{PP}}$, $A_v = -1$, $R_L = 100\ \Omega$ to $V_+/2$		80		dB
		$f = 1\text{ kHz}$, $V_{\text{OUT}} = 2\text{ V}_{\text{PP}}$, $A_v = -1$, $R_L = 2\text{ k}\Omega$ to $V_+/2$		85		dB
e_n	Input-referred voltage noise	$f = 100\text{ kHz}$		40		$\text{nV}/\sqrt{\text{Hz}}$

5.2. 5 V Electrical Characteristics

The typical values are obtained under these conditions unless otherwise specified: $T_A = 25^\circ\text{C}$, $V_+ = 5\text{ V}$, $V_- = 0\text{ V}$, $V_{CM} = V_+ / 2$, $R_L = 2\text{ k}\Omega$ to $V_+ / 2$

Symbol	Parameter	Conditions	Min	Typ	Max	Unit
Power supply						
PSRR	Power supply rejection ratio	$V_+ = 4\text{ V}$ to 6 V , $V_{CM} = 2.5\text{ V}$		90		dB
I_s	Supply current	No load		7		mA
Input						
V_{OS}	Input offset voltage				± 13	mV
V_{CM}	Input common mode voltage range	Low rail		0		V
		High rail		5		
CMRR	Common mode rejection ratio	V_{CM} stepped from 0 V to 3.5 V		80		dB
A_v	Open loop voltage gain	$R_L = 2\text{ k}\Omega$ to $V_+ / 2$		97		dB
$\Delta V_{OS} / \Delta T$	Input offset average drift	Offset voltage average drift determined by dividing the change in V_{OS} at temperature extremes by the total temperature change.		± 20		$\mu\text{V}/^\circ\text{C}$
Output						
I_{SC}	Output short circuit current	Sourcing to V_-		60		mA
		Sinking from V_+		70		mA
I_{OUT}	Output Current	$V_{OUT} = 0.5\text{ V}$ from V_+		52		mA
		$V_{OUT} = 0.5\text{ V}$ from V_-		40		mA
V_{OUT}	Output swing high	$R_L = 2\text{ k}\Omega$ to $V_+ / 2$	4.98	4.985		V
	Output swing low	$R_L = 2\text{ k}\Omega$ to $V_+ / 2$	15	20		mV
Dynamic performance						
BW	-3 dB bandwidth	$A_v = +1$, $V_{OUT} = 200\text{ mV}_{PP}$		95		MHz
		$A_v = +2$, $V_{OUT} = 200\text{ mV}_{PP}$		60		MHz
		$A_v = -1$, $V_{OUT} = 200\text{ mV}_{PP}$		37		MHz
SR	Slew rate	$A_v = -1$, $V_{IN} = 2\text{ V}_{PP}$		125		$\text{V}/\mu\text{s}$
t_s	Settling time	$V_{OUT} = 2\text{ V}_{PP}$, $\pm 1\%$, 8 pF load		100		ns
Noise performance						
THD	Total harmonic distortion	$f = 1\text{ kHz}$, $V_O = 2\text{ V}_{PP}$, $A_v = -1$, $R_L = 100\ \Omega$ to $V_+ / 2$		80		dB
		$f = 1\text{ kHz}$, $V_{OUT} = 2\text{ V}_{PP}$, $A_v = -1$, $R_L = 2\text{ k}\Omega$ to $V_+ / 2$		85		dB
e_n	Input-referred voltage noise	$f = 100\text{ kHz}$		40		$\text{nV}/\sqrt{\text{Hz}}$

Note: Specifications subject to change without notice.

5.3. 10 V Electrical Characteristics

The typical values are obtained under these conditions unless otherwise specified: $T_A = 25^\circ\text{C}$, $V_+ = 10\text{ V}$, $V_- = 0\text{ V}$, $V_{CM} = V_+/2\text{ V}$, $R_L = 2\text{ k}\Omega$ to $V_+/2$.

Symbol	Parameter	Conditions	Min	Typ	Max	Unit
--------	-----------	------------	-----	-----	-----	------

Power supply

PSRR	Power supply rejection ratio	$V_+ = 4\text{ V}$ to 6 V , $V_{CM} = 0\text{ V}$		90		dB
I_S	Supply current	No load		7		mA

Input

V_{OS}	Input offset voltage				± 13	mV
V_{CM}	Input common mode voltage range	Low rail		0		V
		High rail		10		
CMRR	Common mode rejection ratio	V_{CM} stepped from 0 V to 3.5 V		80		dB
$A_V^{(1)}$	Open loop voltage gain	$R_L = 2\text{ k}\Omega$		96		dB
$\Delta V_{OS}/\Delta T$	Input offset average drift	Offset voltage average drift determined by dividing the change in V_{OS} at temperature extremes by the total temperature change.		± 20		$\mu\text{V}/^\circ\text{C}$

Output

I_{SC}	Output short circuit current	Sourcing to V_-		60		mA
		Sinking from V_+		60		mA
I_{OUT}	Output current	$V_{OUT} = 0.5\text{ V}$ from V_+		54		mA
		$V_{OUT} = 0.5\text{ V}$ from V_-		40		mA
V_{OUT}	Output swing high	$R_L = 2\text{ k}\Omega$	9.98	9.985		V
	Output swing low	$R_L = 2\text{ k}\Omega$	30			mV

Dynamic performance

BW	-3 dB bandwidth	$A_V = +1$, $V_{OUT} = 200\text{ mV}_{PP}$		100		MHz
		$A_V = +2$, $V_{OUT} = 200\text{ mV}_{PP}$		63		MHz
		$A_V = -1$, $V_{OUT} = 200\text{ mV}_{PP}$		39		MHz
SR	Slew rate	$A_V = -1$, $V_I = 2\text{ V}_{PP}$		125		$\text{V}/\mu\text{s}$
t_S	Settling time	$V_{OUT} = 2\text{ V}_{PP}$, $\pm 1\%$, 8 pF load, $V_S = 5\text{ V}$		110		ns

Noise performance

THD	Total harmonic distortion	$f = 1\text{ kHz}$, $V_{OUT} = 2\text{ V}_{PP}$, $A_V = -1$, $R_L = 100\ \Omega$ to $V_+/2$		80		dB
		$f = 1\text{ kHz}$, $V_{OUT} = 2\text{ V}_{PP}$, $A_V = -1$, $R_L = 2\text{ k}\Omega$ to $V_+/2$		85		dB
e_n	Input-referred voltage noise	$f = 100\text{ kHz}$		40		$\text{nV}/\sqrt{\text{Hz}}$

Note:

- (1) Guaranteed by design.
- (2) Specifications subject to change without notice.

6. Typical Characteristics

$V_+ = +5\text{ V}$, $V_- = -5\text{ V}$, $R_L = 2\text{ k}\Omega$, unless otherwise specified.

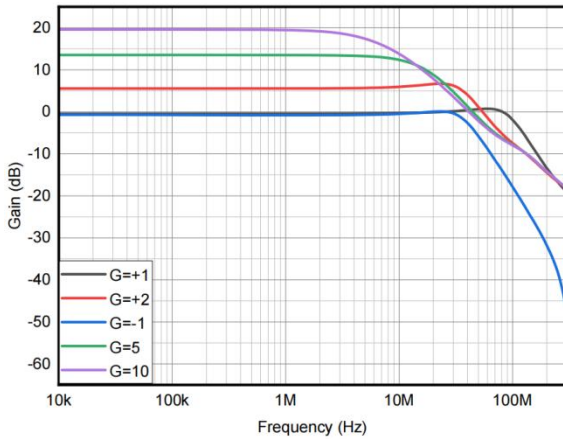

Figure 1. Closed loop gain vs. frequency for various gain

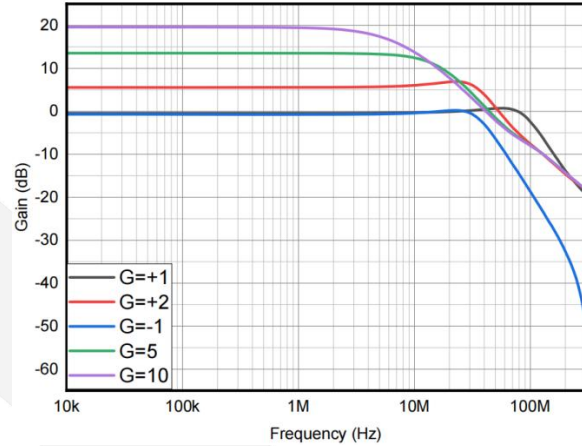

Figure 2. Closed loop gain vs. frequency for various gain

$V_S = 3\text{ V}$, $V_{OUT} = 0.2\text{ V}_{PP}$

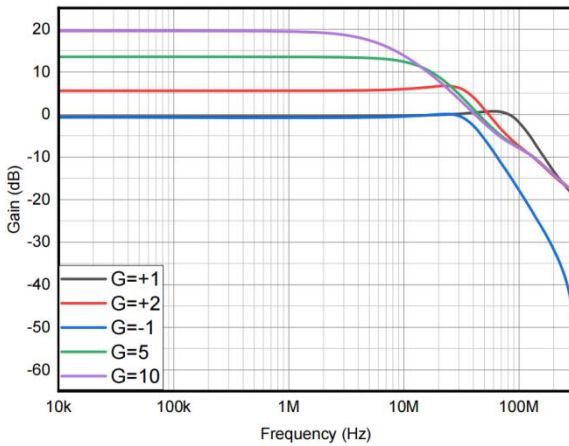

Figure 3. Closed loop gain vs. frequency for various gain

$V_S = 5\text{ V}$, $V_{OUT} = 0.2\text{ V}_{PP}$

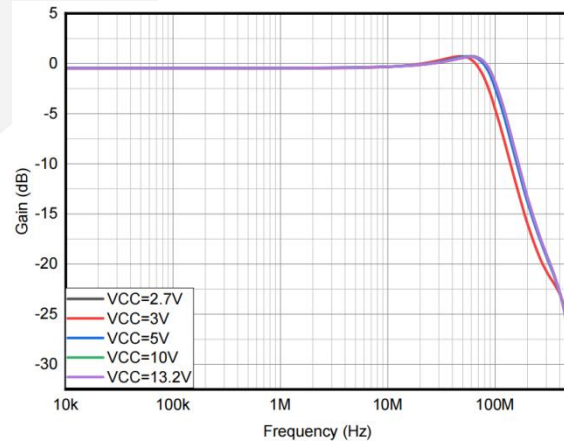

Figure 4. Closed loop frequency response for various supplies

$V_S = 10\text{ V}$, $V_{OUT} = 0.2\text{ V}_{PP}$

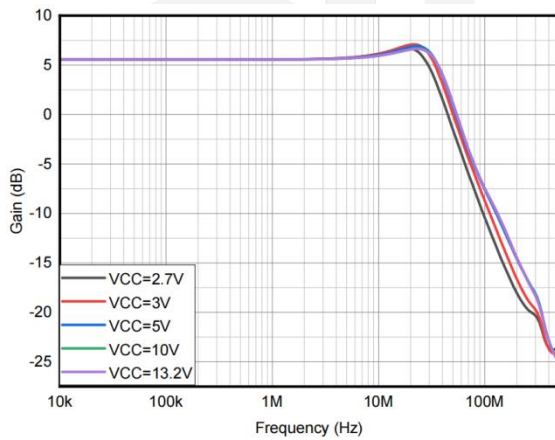

Figure 5. Closed loop frequency response for various supplies

$G = +2$, $V_{OUT} = 0.2\text{ V}_{PP}$

$G = +1$, $V_{OUT} = 0.2\text{ V}_{PP}$

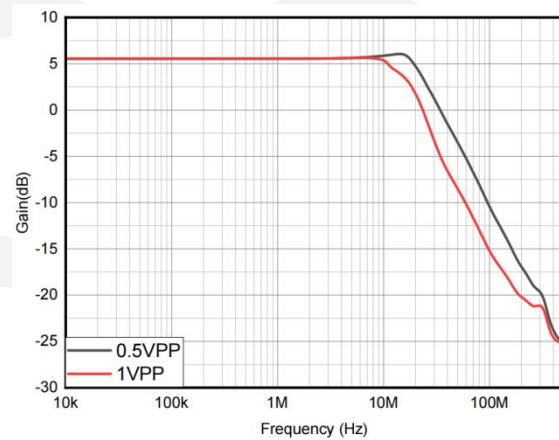

Figure 6. Large signal frequency response

$V_S = 10\text{ V}$, $G = +2$

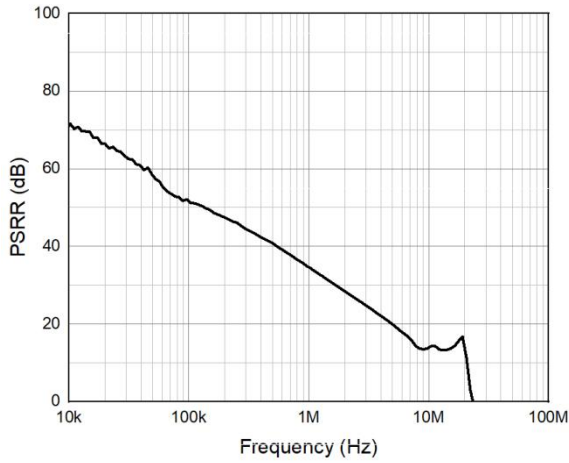

Figure 7. PSRR vs. frequency
 $V_S = 5\text{ V}, A_V = +1$

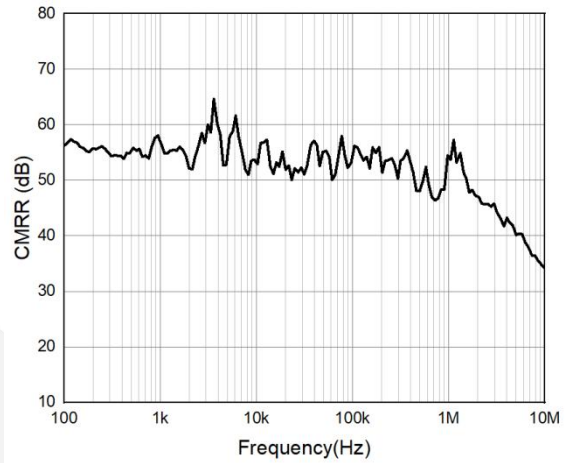

Figure 8. CMRR vs. frequency
 $V_S = 5\text{ V}, A_V = +2$

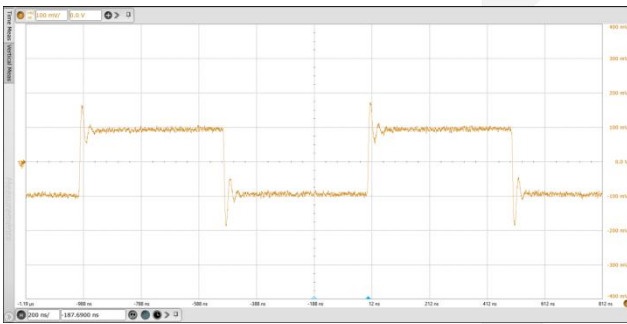

Figure 9. Small signal step response
 $V_S = 3\text{ V}, V_{OUT} = 0.2\text{ V}_{PP}, G = 2$

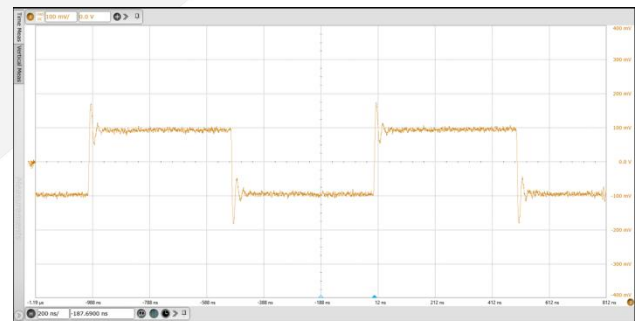

Figure 10. Small signal step response
 $V_S = 10\text{ V}, V_{OUT} = 0.2\text{ V}_{PP}, G = 2$

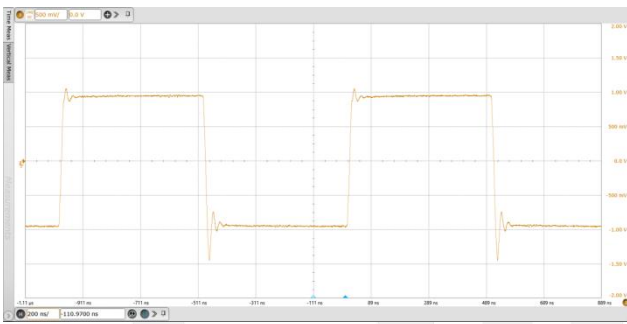

Figure 11. Large signal step response
 $V_S = 10\text{ V}, V_{OUT} = 2\text{ V}_{PP}$

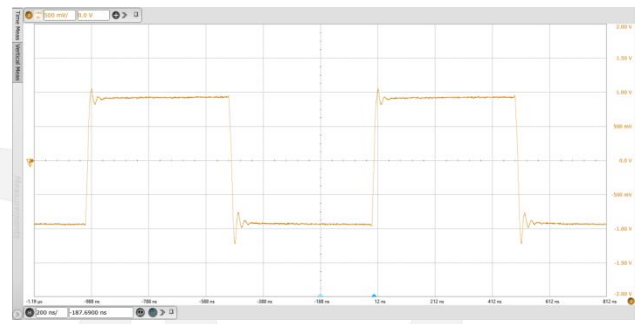

Figure 12. Large signal step response
 $V_S = 10\text{ V}, V_{OUT} = 2\text{ V}_{PP}, G = -1$

7. Feature Description

The DIA2641 is designed for high-voltage, high-speed amplifier applications. The DIA2641 has low power dissipation, due to the lower supply current. The push-pull output stage offers a 54 mA output current (at 0.5 V from the supply rails); meanwhile, the total consumption of the supply current is only 7 mA. As high-performance devices, due to the subtleties of applications, it is recommended to evaluate performance under actual operating conditions to ensure the chip meets all specifications.

The DIA2641 is a high-speed, high-voltage, rail-to-rail input, rail-to-rail output Op Amp. The DIA2641 has a wide power supply voltage ranging from 2.7 V to 13.2 V. Even when supplied with 3 V, the -3 dB BW (at $A_v = +1$) is typically 78 MHz. Production testing guarantees that process variations will not compromise the speed.

The DIA2641 device can operate off a single supply or with dual supplies. The input CM capability of the parts (CMVR) extends down to the V- rail to simplify single supply applications. Supplies should be decoupled with low inductance, often ceramic, capacitors to ground less than 0.5 inches from the device pins. The use of a ground plane is recommended, and as in most high-speed devices, it is advisable to remove ground plane close to device-sensitive pins such as the inputs.



8. Typical Applications

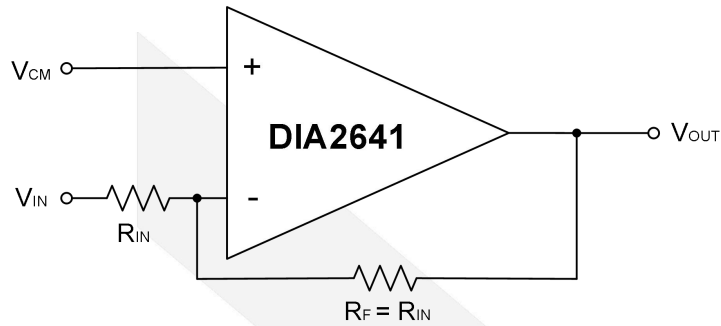

Figure 13. Typical application: gain = -1

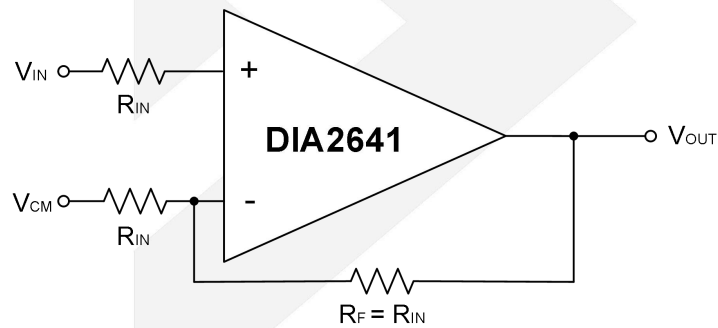

Figure 14. Typical application: gain = 2

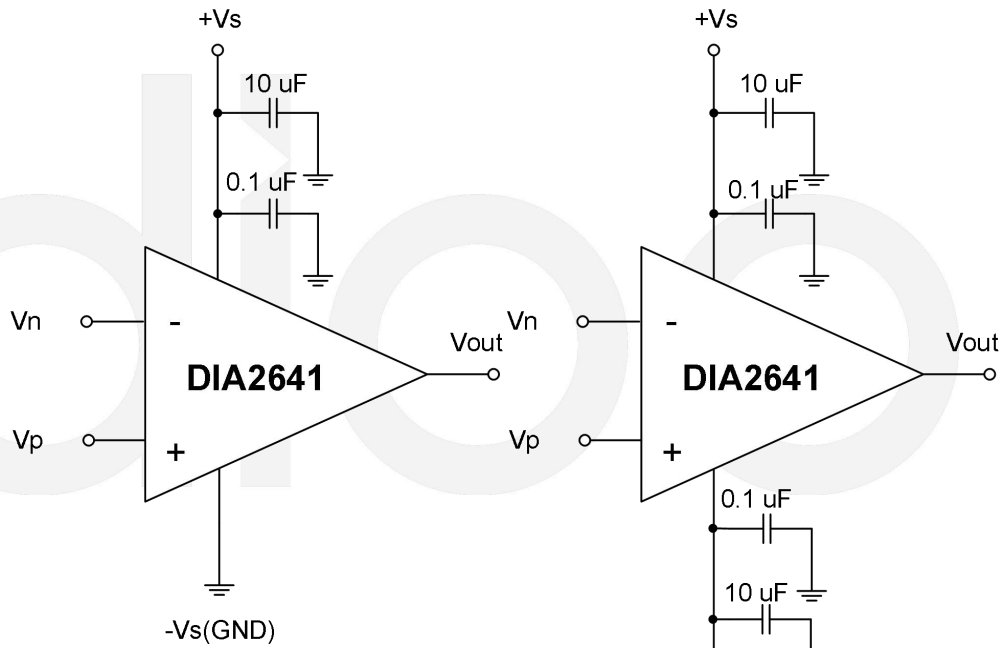
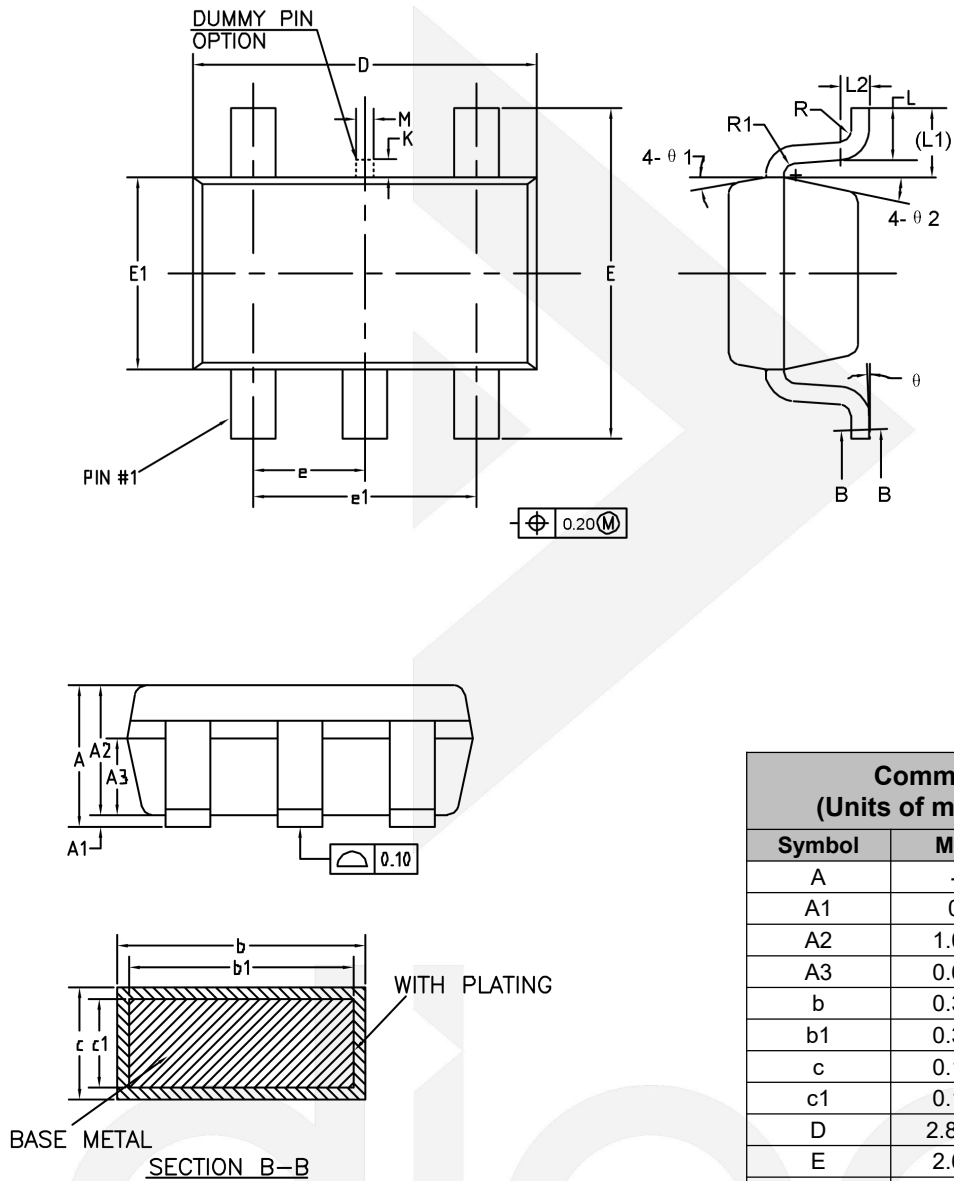

Figure 15. Amplifier with bypass capacitors

9. Physical Dimensions: SOT23-5



Common Dimensions (Units of measure = Millimeter)			
Symbol	Min	Nom	Max
A	-	-	1.25
A1	0	-	0.15
A2	1.00	1.10	1.20
A3	0.60	0.65	0.70
b	0.36	-	0.45
b1	0.35	0.38	0.41
c	0.14	-	0.20
c1	0.14	0.15	0.16
D	2.826	2.926	3.026
E	2.60	2.80	3.00
E1	1.526	1.626	1.726
e	0.90	0.95	1.00
e1	1.80	1.90	2.00
K	0	-	0.25
L	0.30	0.40	0.60
L1	0.59 REF		
L2	0.25 BSC		
M	0.10	0.15	0.25
R	0.05	-	0.20
R1	0.05	-	0.20
θ	0°	-	8°
θ1	8°	10°	12°
θ2	10°	12°	14°

Disclaimer

This specification and information contained herein are provided on an “AS IS” basis and WITH ALL FAULTS. All product specifications, statements, information, and data (collectively, the “Information”) in this datasheet or made available on the website of www.diao.com are subject to change without notice. The customer is responsible for checking and verifying the extent to which the Information contained in this publication is applicable to his/her application. All Information given herein is believed to be accurate and reliable, but it is presented without guarantee, warranty, or responsibility of any kind, express or implied.

A large, light gray watermark of the "diao" logo is centered on the page, serving as a background element.

X-ON Electronics

Largest Supplier of Electrical and Electronic Components

Click to view similar products for [Analogue Switch ICs](#) category:

Click to view products by [Dioo](#) manufacturer:

Other Similar products are found below :

[FSA3051TMX](#) [NLAS5223BLMNR2G](#) [NLX2G66DMUTCG](#) [TC74HC4066AFTEL](#) [425541DB](#) [DG403DY](#) [099044FB](#) [MAX4762ETB+](#)
[NLAS3799BMNR2G](#) [NLAS5123MNR2G](#) [ISL84684IR](#) [PI5A4157CEX](#) [PI5A4599BCEX](#) [NLAS4717EPFCT1G](#) [PI5A3167CCEX](#)
[SLAS3158MNR2G](#) [PI5A392AQE](#) [ADG714BCPZ-REEL7](#) [DG333ALDW-T1-E3](#) [ISL43113IB](#) [ISL43140IB](#) [ISL43140IBZ-T](#) [ISL43143IR](#)
[ISL43L120IR](#) [ISL43L121IR](#) [ISL43L122IR](#) [ISL43L220IR](#) [ISL43L410IR](#) [ISL43L420IR](#) [ISL43L710IR](#) [ISL43L711IR](#) [ISL43L712IR](#)
[ISL84053IA](#) [ISL84514IB](#) [ISL84516IB](#) [ISL84684IUZ-T](#) [LNLASB3157DFT2G](#) [NLAS324US](#) [NLASTV4599DFT2G](#) [TPW4053-SR](#)
[WAS4642Q-24/TR](#) [ADG842YKSZ-REEL7](#) [WAS4766C-9/TR](#) [WAS7227Q-10/TR](#) [WAS4646C-36/TR](#) [WAS4735Q-16/TR](#) [BL1532TQFN](#)
[RS2233YS16](#) [CH483M](#) [TMUX1248DCKR](#)