

DIO233X/B

Ultra Low Vos, Low Power Amplifier

Features

- Ultra low V_{OS} : DIO233X:15 μ V(Max)
DIO233XB:35 μ V(Max)
- Low Power: 1.0 μ A(typ.)
- Unity Gain Stable
- Gain Bandwidth Product: 30kHz(typ.)
- Wide supply range: 1.8V to 5.5V
- Available in SOT23-5, SOT23-6, SOIC-8, MSOP-8, SOIC-14 and TSSOP-14 packages
- Temperature Range:-40°C to 125°C

Descriptions

DIO233X/B is a family of ultra low V_{OS} operational amplifier, with rail-to-rail CMOS input/output and single/dual channels selectable. DIO233X/B family has a gain-bandwidth product of 30kHz(typ.), wide operating supply voltage from 1.8V to 5.5V and broad output voltage swing.

DIO233X/B consumes ultra low power, with each channel 1.0 μ A(typ.) of bias current, which makes DIO233X/B be ideal for battery powered device, temperature-sense device, etc.

Typical Applications

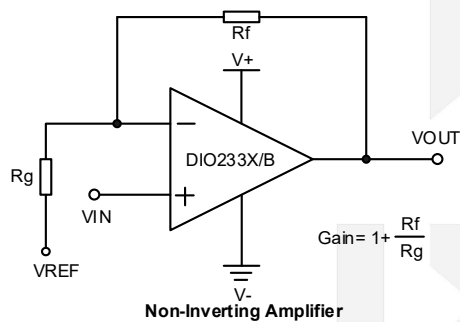

Applications

- Toll Booth Tags
- Wearable Products
- Battery Current Monitoring
- Sensor Conditioning
- Battery Powered

Ordering Information

Order Part Number	Top Marking		T _A	Package	
DIO2331ST5	31YW	Green or RoHS	-40 to 125°C	SOT23-5	Tape & Reel, 3000
DIO2331BST5	31YW	Green or RoHS	-40 to 125°C	SOT23-5	Tape & Reel, 3000
DIO2331SO8	DIO2331	Green or RoHS	-40 to 125°C	SOIC-8	Tape & Reel, 2500
DIO2331BSO8	DIO2331	Green or RoHS	-40 to 125°C	SOIC-8	Tape & Reel, 2500
DIO2331MP8	DIO2331	Green or RoHS	-40 to 125°C	MSOP-8	Tape & Reel, 3000
DIO2331BMP8	DIO2331	Green or RoHS	-40 to 125°C	MSOP-8	Tape & Reel, 3000
DIO2331DST6	31DW	Green or RoHS	-40 to 125°C	SOT23-6	Tape & Reel, 3000
DIO2331DBST6	31DW	Green or RoHS	-40 to 125°C	SOT23-6	Tape & Reel, 3000
DIO2332SO8	DIO2332	Green or RoHS	-40 to 125°C	SOIC-8	Tape & Reel, 2500
DIO2332BSO8	DIO2332	Green or RoHS	-40 to 125°C	SOIC-8	Tape & Reel, 2500
DIO2332MP8	DIO2332	Green or RoHS	-40 to 125°C	MSOP-8	Tape & Reel, 3000
DIO2332BMP8	DIO2332	Green or RoHS	-40 to 125°C	MSOP-8	Tape & Reel, 3000
DIO2333SO8	DIO2333	Green or RoHS	-40 to 125°C	SOIC-8	Tape & Reel, 2500
DIO2333BSO8	DIO2333	Green or RoHS	-40 to 125°C	SOIC-8	Tape & Reel, 2500
DIO2333MP8	DIO2333	Green or RoHS	-40 to 125°C	MSOP-8	Tape & Reel, 3000
DIO2333BMP8	DIO2333	Green or RoHS	-40 to 125°C	MSOP-8	Tape & Reel, 3000
DIO2334SO14	DIO2334	Green or RoHS	-40 to 125°C	SOIC-14	Tape & Reel, 2500
DIO2334BSO14	DIO2334	Green or RoHS	-40 to 125°C	SOIC-14	Tape & Reel, 2500
DIO2334TP14	DIO2334	Green or RoHS	-40 to 125°C	TSSOP-14	Tape & Reel, 2500
DIO2334BTP14	DIO2334	Green or RoHS	-40 to 125°C	TSSOP-14	Tape & Reel, 2500

Ordering Information Complimentary Note

Ordering Code = Part No. + Package Code

DIO2331/1B/1D/1DB
DIO2332/2B
DIO2333/3B
DIO2334/4B

ST5: stands for SOT23-5
ST6: stands for SOT23-6
SO8: stands for SOIC-8
MP8: stands for MSOP-8
SO14: stands for SOIC-14
TP14: stands for TSSOP-14

Pin Assignments

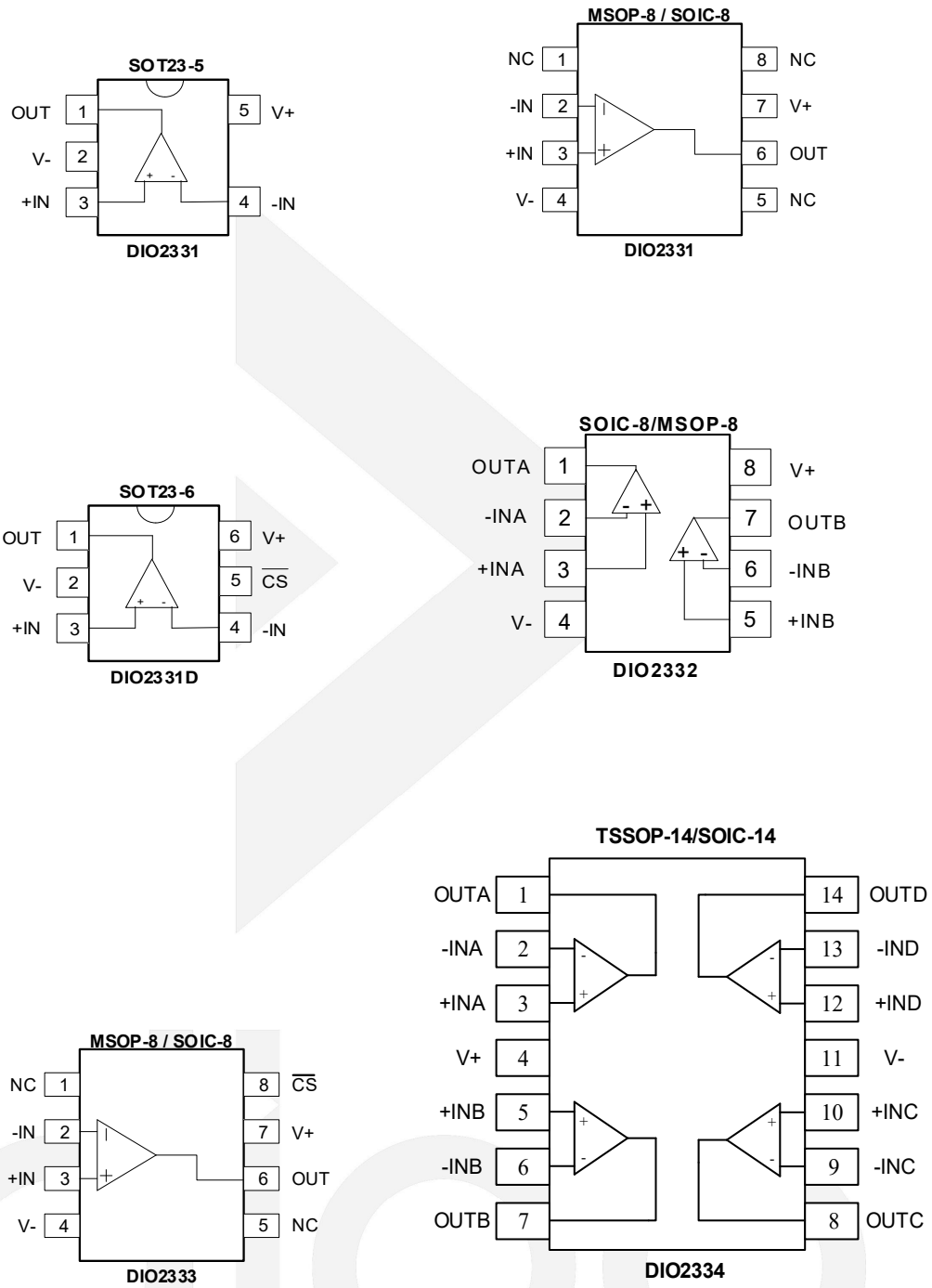

Figure 1 Top View

Pin Description

Pin name	Description
V+	Positive supply
V-	Negative supply
+INX	Positive Input
-INX	Negative Input
OUTX	Output
NC	No connect
$\overline{\text{CS}}$	Power saving Chip Select

Absolute Maximum Ratings

Stresses beyond those listed under "Absolute Maximum Rating" may cause permanent damage to the device. These are stress ratings only and functional operation of the device at these or any other condition beyond those indicated in the operational sections of the specifications is not implied. Exposure to absolute maximum rating conditions for extended periods may affect device reliability.

Parameter	Rating	Unit	
V+ – V-	7	V	
Current at Input Pins	±2	mA	
Input Voltage	(V-)-0.3V to (V+)+0.3V	V	
Difference Input Voltage	V+ – V-		
Output Short-Circuit Current	Continuous		
Current at Output and Supply Pins	±30	mA	
Storage Temperature	-65 to 150	°C	
Maximum Junction Temperature(T _J)	150	°C	
ESD protection on all pins (HBM)	7.5	kV	
Package Thermal Resistance(θ _{JA})	SOT23-5	256	°C/W
	SOIC-8	163	°C/W
	MSOP-8	206	°C/W
	SOIC-14	120	°C/W
	TSSOP-14	100	°C/W
Operating Temperature Range(T _A)	-40~125	°C	

DC Electrical Characteristics

Unless otherwise indicated, $V_+ = 1.8V$ to $5.5V$, $V_- = 0$, $T_A = 25^\circ C$, $V_{CM} = V_+/2$, $R_L = 1M\Omega$ to V_{CM} .

Symbol	Parameter	Conditions	Min.	Typ.	Max.	Unit
Input Offset						
V_{OS}	Input Offset Voltage	$V_+ = 1.8 \sim 5.5V, V_{CM} = (V_+)/2$	DIO233X	-15	15	μV
			DIO233XB	-35	35	
$\Delta V_{OS}/\Delta T_A$	Input Offset Drift with Temperature	$T_A = -40^\circ C$ to $125^\circ C, V_+ = 1.8 \sim 5.5V, V_{CM} = (V_+)/2$		± 0.15		$\mu V/^\circ C$
PSRR	Power Supply Rejection Ratio	$V_{CM} = (V_+)/2$	100	110		dB
Input Bias Current and Impedance						
I_B	Input Bias Current	$T_A = 25^\circ C$		± 1.0		pA
		$T_A = 85^\circ C$		60		pA
		$T_A = 125^\circ C$		2000		pA
I_{OS}	Input Offset Current			± 1.0		pA
Z_{CM}	Common Mode Input Impedance			$10^{13} 6$		ΩpF
Z_{DIFF}	Differential Input Impedance			$10^{13} 6$		ΩpF
Common Mode						
V_{CMR}	Common Mode Input Voltage Range		(V-) 0.1		(V+) 0.1	V
CMRR	Common Mode Rejection Ratio	V_{CM} from (V-)-0.1 to (V+)+0.1	100	110		dB
Open-Loop Gain						
A_{OL}	DC Open-Loop Gain (Large Signal)	$0.2V < V_{OUT} < (V_+ - 0.2V), R_L = 50k\Omega$ to V_L		120		dB
Output						
V_{OL}	Output Voltage Low	$V_+ = 5V, R_L = 50k$ to $V_+/2$		4.8		mV
V_{OH}	Output Voltage High	$V_+ = 5V, R_L = 50k$ to GND		4.994		V
I_{SC}	Output Short-Circuit Current	$V_+ = 1.8V$		3		mA
		$V_+ = 5V$		30		
Power Supply						
THD		$V_+ = 5V, V_{PP} = 2V, R_L = 50k$, Frequency = 100Hz		0.13		%

		V+=5V, V _{PP} =2V, R _L =50k, Frequency=200Hz		0.26		
		V+=5V, V _{PP} =2V, R _L =50k, Frequency=250Hz		0.33		
		V+=5V, V _{PP} =2V, R _L =50k, Frequency=500Hz		0.62		
V+	Supply Voltage		1.8		5.5	V
I _Q	Quiescent Current per Amplifier	I _O =0, V _{CM} =(V+)/2, V+=5.0V		1.0		μA

Specifications subject to change without notice.

AC Electrical Characteristics

Unless otherwise indicated, T_A=25°C, V+=1.8 to 5.5V, V-=0, V_{CM}=V+/2, C_L=60pF, R_L=1MΩ to V_{CM}.

Symbol	Parameter	Conditions	Min.	Typ.	Max.	Unit
AC Response						
GBWP	Gain Bandwidth Product			30		kHz
PM	Phase Margin	G=1V/V		65		°
SR	Slew Rate			10		V/ms
Noise						
Eni	Input Noise Voltage	f=0.1Hz to 10Hz		3.9		μVp-p
e _{ni}	Input Noise Voltage Density	f=1kHz		165		nV/√Hz
i _{ni}	Input Noise Current Density	f=1kHz		0.6		fA/√Hz

Specifications subject to change without notice.

Typical Performance Characteristics

I_{CC} VS V_{CC}

Supply Current Vs. Supply Voltage

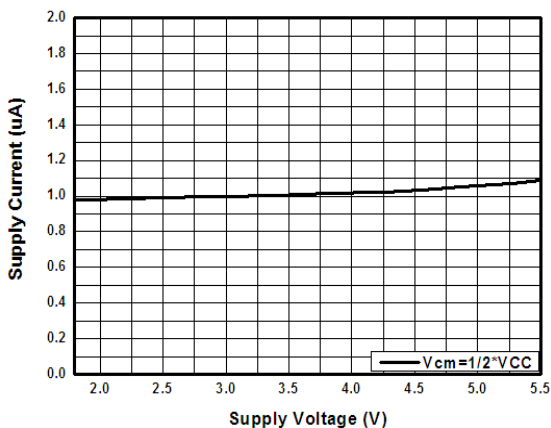

I_{CC} VS TEMP

Supply Current Vs. Temperature

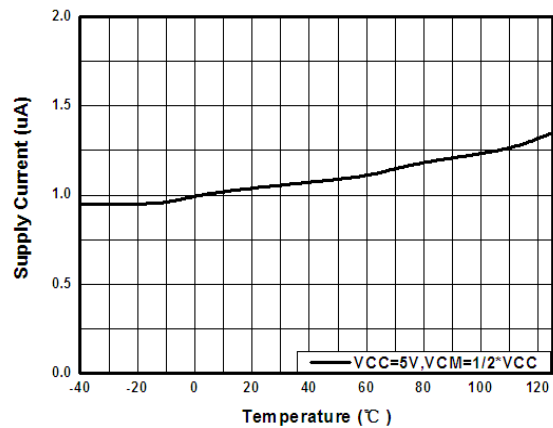

V_{os} VS V_{cc}

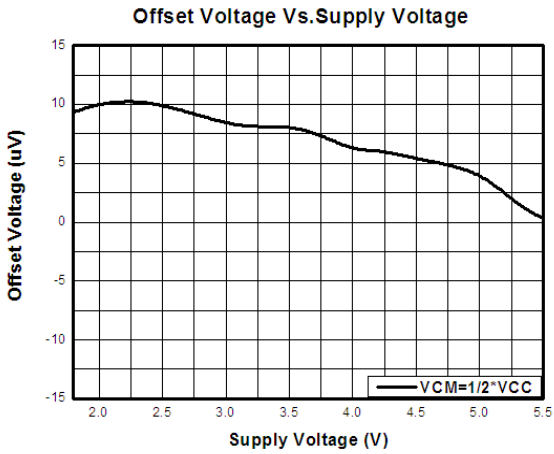

V_{os} VS V_{CM}

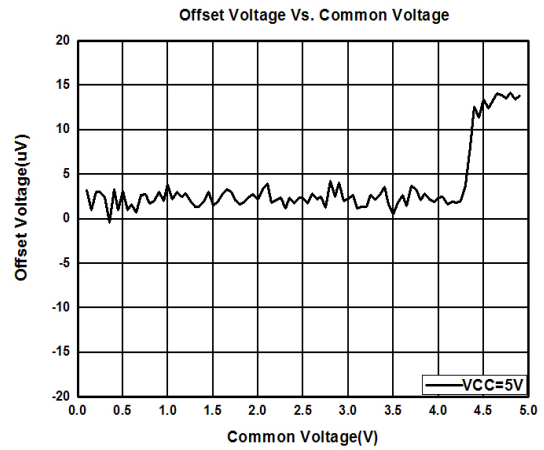

V_{os} VS TEMP

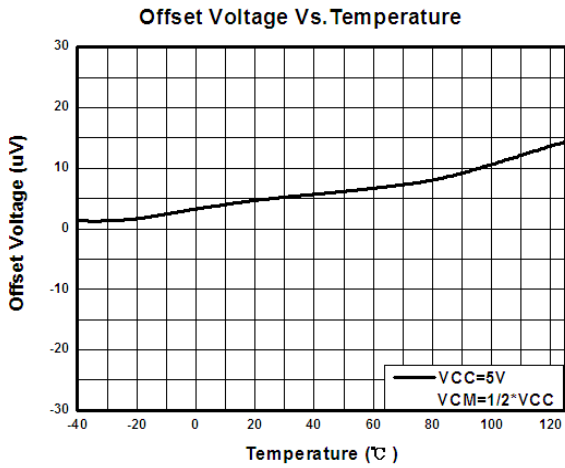

Large-Signal Response

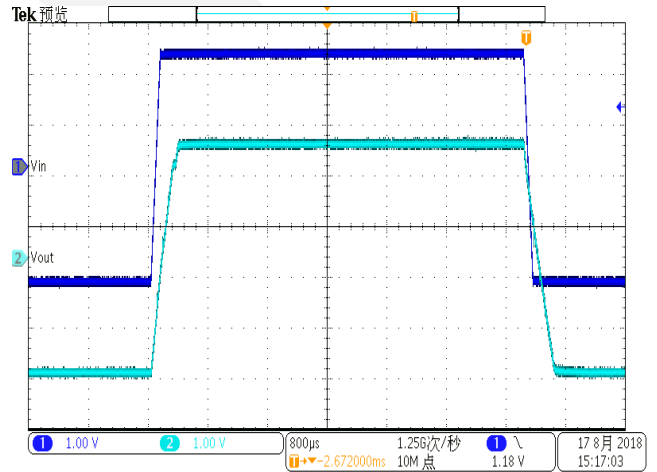

Small-signal response (CL=No Cap)

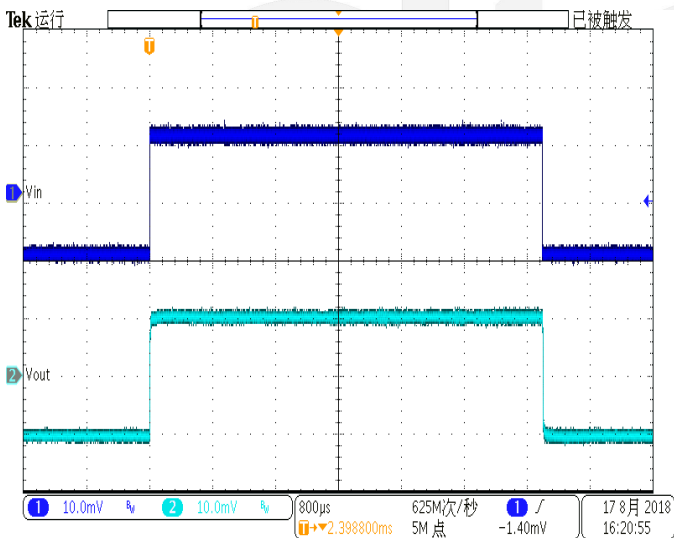

Small-signal response (CL=200p Cap)

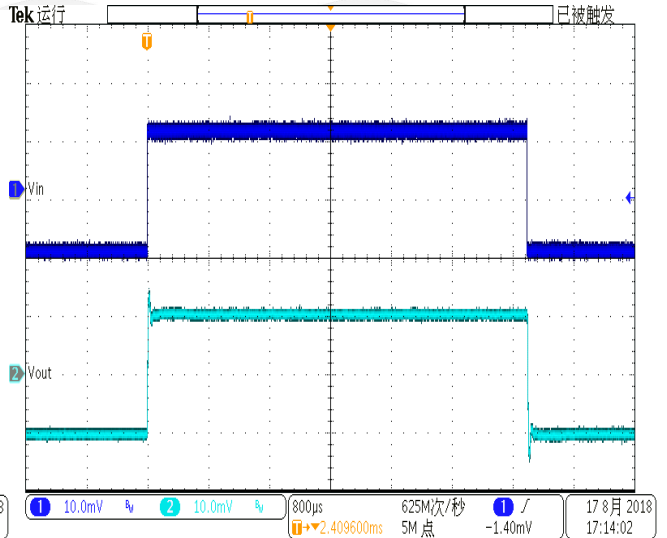

Physical Dimensions: SOT23-5

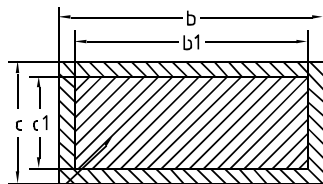
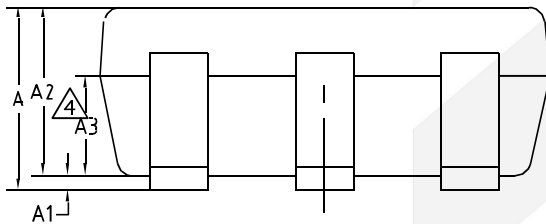
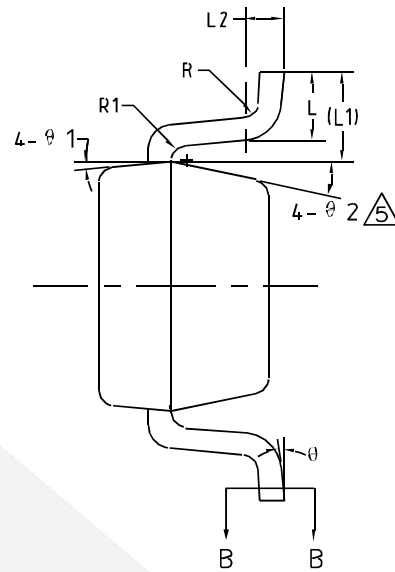
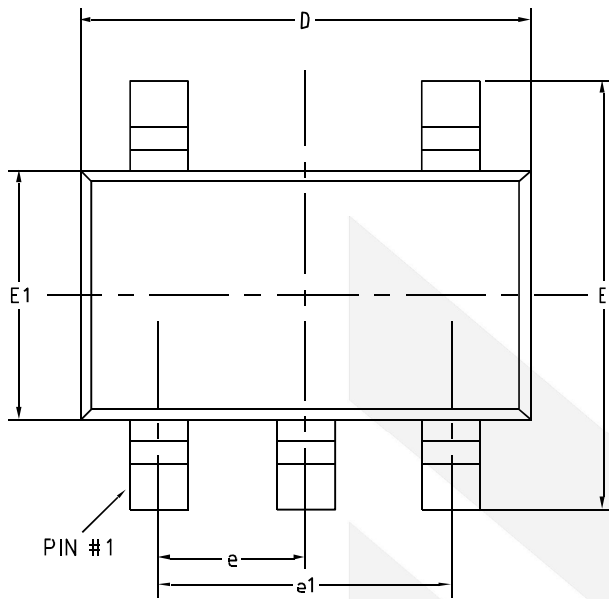

BASE METAL
SECTION B-B

COMMON DIMENSIONS (UNITS OF MEASURE=MILLIMETER)			
Symbol	MIN	NOM	MAX
A	-	-	1.25
A1	0	-	0.15
A2	1.00	1.10	1.20
A3	0.60	0.65	0.70
b	0.36	-	0.50
b1	0.36	0.38	0.45
c	0.14	-	0.20
c1	0.14	0.15	0.16
D	2.826	2.926	3.026
E	2.60	2.80	3.00
E1	1.526	1.626	1.726
e	0.90	0.95	1.00
e1	1.80	1.90	2.00
L	0.35	0.45	0.60
L1	0.59REF		
L2	0.25BSC		
R	0.10	-	-
R1	0.10	-	0.25
θ	0°	-	8°
θ1	3°	5°	7°
θ2	6°	-	14°

Physical Dimensions: SOT23-6

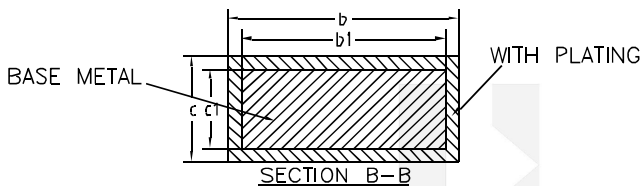
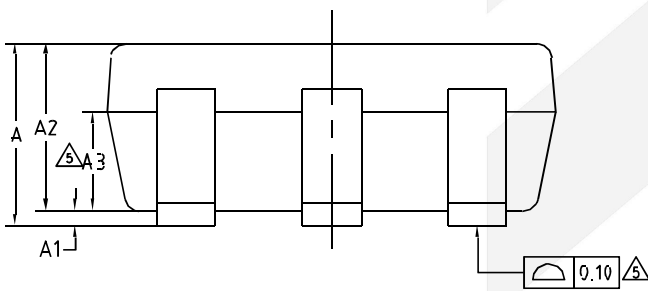
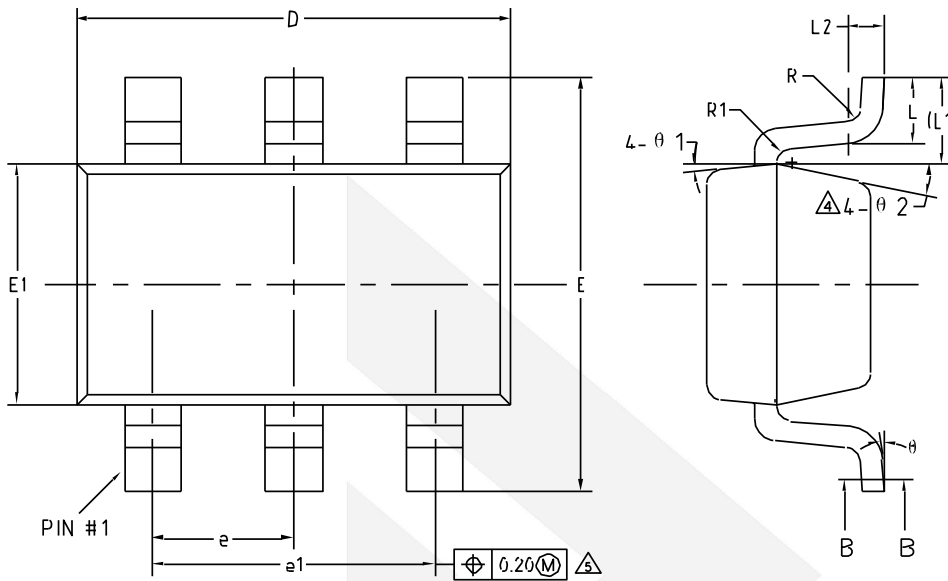

COMMON DIMENSIONS (UNITS OF MEASURE=MILLIMETER)			
Symbol	MIN	NOM	MAX
A	-	-	1.25
A1	0	-	0.15
A2	1.00	1.10	1.20
A3	0.60	0.65	0.70
b	0.36	-	0.50
b1	0.36	0.38	0.45
c	0.14	-	0.20
c1	0.14	0.15	0.16
D	2.826	2.926	3.026
E	2.60	2.80	3.00
E1	1.526	1.626	1.726
e	0.90	0.95	1.00
e1	1.80	1.90	2.00
L	0.35	0.45	0.60
L1	0.59REF		
L2	0.25BSC		
R	0.10	-	-
R1	0.10	-	0.20
θ	0°	-	8°
θ1	3°	5°	7°
θ2	6°	-	14°

Physical Dimensions: SOIC-8

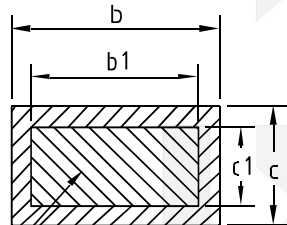
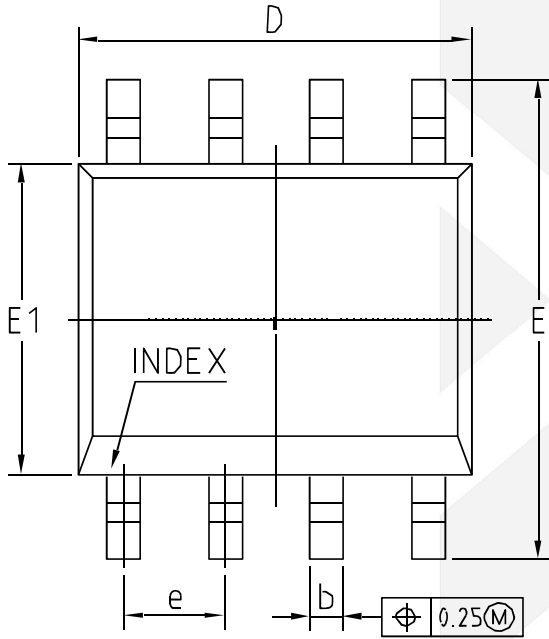
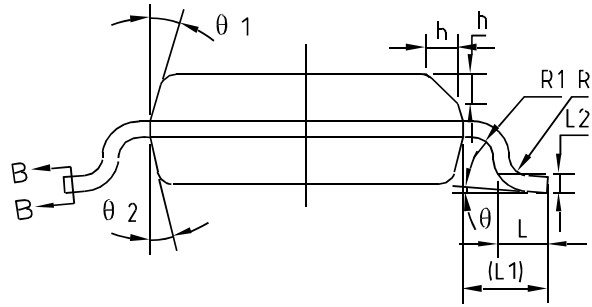
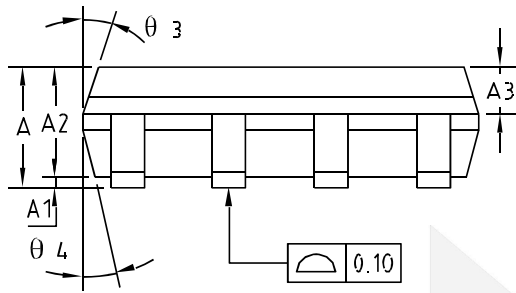

BASE METAL

SECTION B-B

COMMON DIMENSIONS (UNITS OF MEASURE=MILLIMETER)			
Symbol	MIN	NOM	MAX
A	1.35	1.55	1.75
A1	0.10	0.15	0.25
A2	1.25	1.40	1.65
A3	0.50	0.60	0.70
b	0.38	-	0.51
b1	0.37	0.42	0.47
c	0.17	-	0.25
c1	0.17	0.20	0.23
D	4.80	4.90	5.00
E	5.80	6.00	6.20
E1	3.80	3.90	4.00
e	1.27BSC		
L	0.45	0.60	0.80
L1	1.04REF		
L2	0.25BSC		
R	0.07	-	-
R1	0.07	-	-
h	0.30	0.40	0.50
θ	0°	-	8°
θ1	15°	17°	19°
θ2	11°	13°	15°
θ3	15°	17°	19°
θ4	11°	13°	15°

Physical Dimensions: MSOP-8

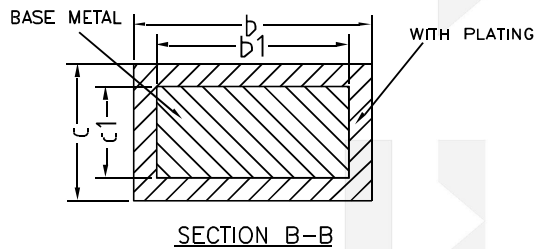
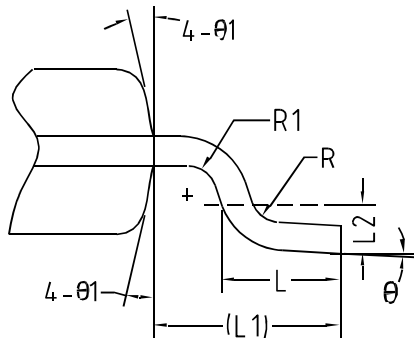
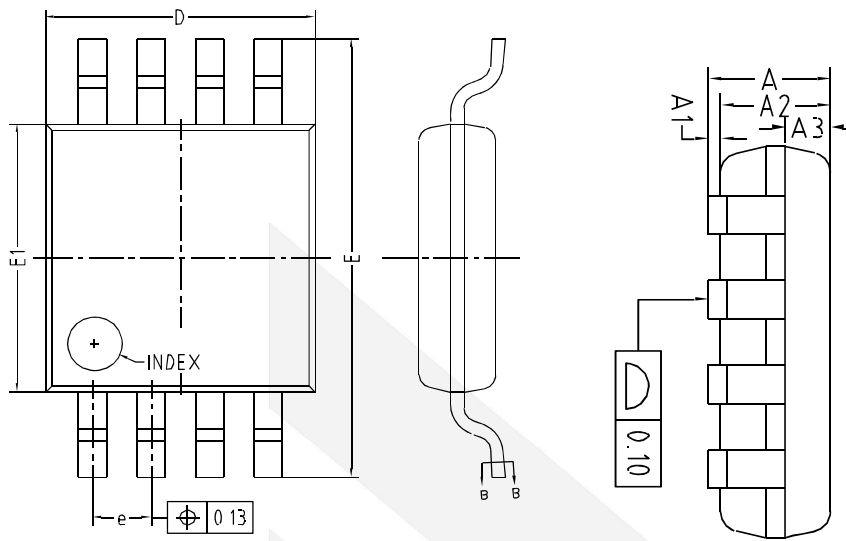

COMMON DIMENSIONS (UNITS OF MEASURE=MILLIMETER)			
Symbol	MIN	NOM	MAX
A	-	-	1.10
A1	0	-	0.15
A2	0.75	0.85	0.95
A3	0.25	0.35	0.39
b	0.28	-	0.37
b1	0.27	0.30	0.33
c	0.15	-	0.20
c1	0.14	0.15	0.16
D	2.90	3.00	3.10
E	4.70	4.90	5.10
E1	2.90	3.00	3.10
e	0.55	0.65	0.75
L	0.40	0.60	0.80
L1	0.95REF		
L2	0.25BSC		
R	0.07	-	-
R1	0.07	-	-
θ	0°	-	8°
θ1	9°	12°	15°

Physical Dimensions: SOIC-14

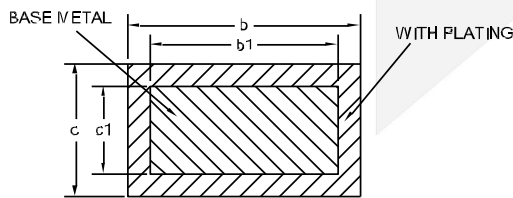
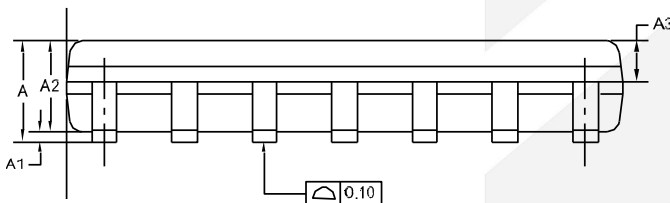
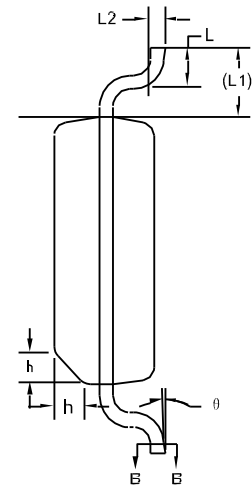
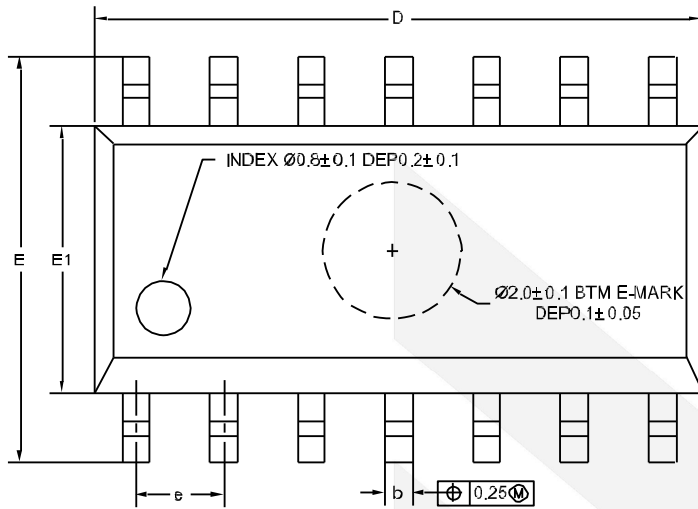

SECTION B-B

COMMON DIMENSIONS (UNITS OF MEASURE=MILLIMETER)			
Symbol	MIN	NOM	MAX
A	1.35	1.60	1.75
A1	0.10	0.15	0.25
A2	1.25	1.45	1.65
A3	0.55	0.65	0.75
b	0.36	-	0.49
b1	0.35	0.40	0.45
c	0.17	-	0.25
c1	0.17	0.20	0.23
D	8.53	8.63	8.73
E	5.80	6.00	6.20
E1	3.80	3.90	4.00
e	1.27BSC		
L	0.45	0.60	0.80
L1	1.04REF		
L2	0.25BSC		
R	0.07	-	-
R1	0.07	-	-
h	0.30	0.40	0.50
θ	0°	-	8°
θ1	6°	8°	10°

Physical Dimensions: TSSOP-14

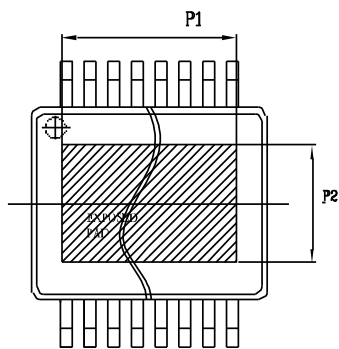
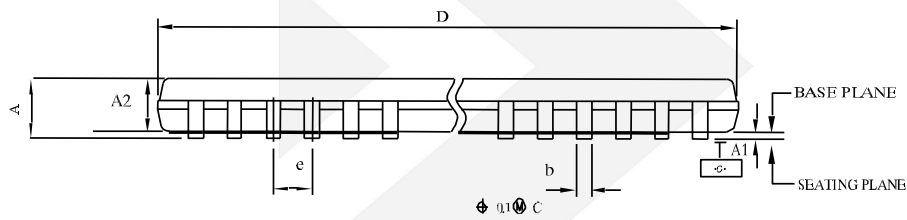
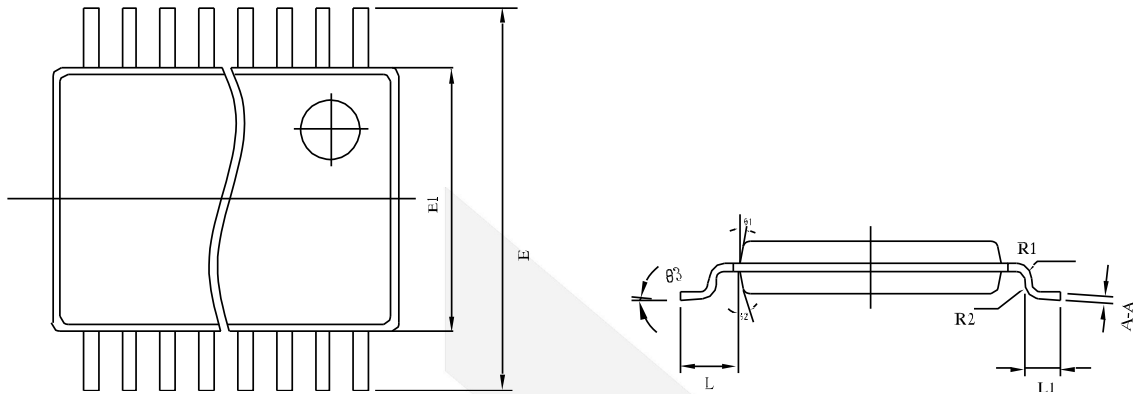

COMMON DIMENSIONS (UNITS OF MEASURE=MILLIMETER)			
Symbol	MIN	NOM	MAX
A	-	-	1.2
A1	0.05	-	0.15
A2	0.8	-	1.05
E	6.25	-	6.55
E1	4.3	-	4.5
D	4.9	-	5.1
L	-	-	1.0
L1	0.45	-	0.75
e	0.65		
b	0.19	-	0.30
R1	0.15TYP		
R2	0.15TYP		
A-A	0.09	-	0.20
Ø1	12°TYP		
Ø2	12°TYP		
Ø3	0°	-	8°

CONTACT US

Dioo is a professional design and sales corporation for high-quality and performance analog semiconductors. The company focuses on industry markets, such as, cell phone, handheld products, laptop, and medical equipment and so on. Dioo's product families include analog signal processing and amplifying, LED drivers and charger IC. Go to <http://www.dioo.com> for a complete list of Dioo product families.

For additional product information, or full datasheet, please contact with our Sales Department or Representatives.



X-ON Electronics

Largest Supplier of Electrical and Electronic Components

Click to view similar products for [Operational Amplifiers - Op Amps](#) category:

Click to view products by [Dioo](#) manufacturer:

Other Similar products are found below :

[OPA2991IDSGR](#) [OPA607IDCKT](#) [007614D](#) [633773R](#) [635798C](#) [635801A](#) [702115D](#) [709228FB](#) [741528D](#) [NCV33072ADR2G](#)
[SC2902DTBR2G](#) [SC2903DR2G](#) [SC2903VDR2G](#) [LM258AYDT](#) [LM358SNG](#) [430227FB](#) [430228DB](#) [460932C](#) [AZV831KTR-G1](#) [409256CB](#)
[430232AB](#) [LM2904DR2GH](#) [LM358YDT](#) [LT1678IS8](#) [042225DB](#) [058184EB](#) [070530X](#) [SC224DR2G](#) [SC239DR2G](#) [SC2902DG](#)
[SCYA5230DR2G](#) [714228XB](#) [714846BB](#) [873836HB](#) [MIC918YC5-TR](#) [TS912BIYDT](#) [NCS2004MUTAG](#) [NCV33202DMR2G](#)
[M38510/13101BPA](#) [NTE925](#) [SC2904DR2G](#) [SC358DR2G](#) [LM358EDR2G](#) [AZV358MTR-G1](#) [AP4310AUMTR-AG1](#) [HA1630D02MMEL-E](#)
[NJM358CG-TE2](#) [HA1630S01LPEL-E](#) [LM324AWPT](#) [HA1630Q06TELL-E](#)