

DIO6507

High-Efficiency 1A Output Synchronous Step Down Converter

Features

- Low $R_{DS(ON)}$ for internal switches (top/bottom) 230m Ω /170m Ω , 1A
- 2.5-5.9V input voltage range
- 40 μ A typical quiescent current
- High light load efficiency
- High switching frequency 1.5MHz minimizes the external components
- Ultra low (<1% typical) line & load regulation
- Green package: DFN1.6*1.6-6 is pin compatible

Descriptions

The DIO6507 is high-efficiency, high frequency synchronous step-down DC-DC regulator ICs capable of delivering up to 1A output currents. The DIO6507 family operate over a wide input voltage range from 2.5V to 5.9V and integrate main switch and synchronous switch with very low $R_{DS(ON)}$ to minimize the conduction loss. Low output voltage ripple and small external inductor and capacitor sizes are achieved with greater than 1.5MHz switching frequency.

Applications

- Portable Navigation Device
- Set Top Box
- USB Dongle
- Media Player
- Smart phone

Function Block

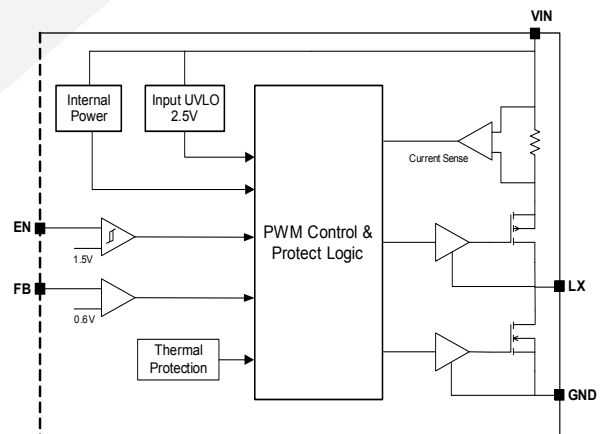

Ordering Information

Order Part Number	Top Marking		T_A	Package	
DIO6507FN6	YW(X)Z	Green	-40 to +85°C	DFN1.6*1.6-6	Tape & Reel, 3000

Marking Information

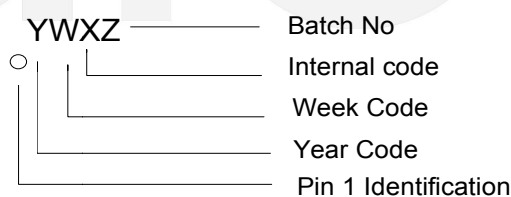

Pin Assignments

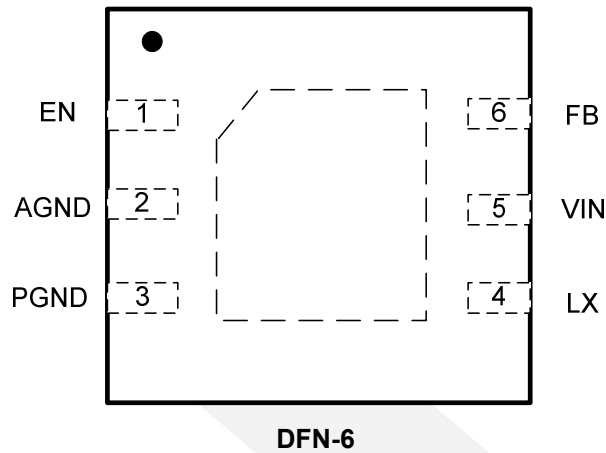

Figure 1 Pin Assignment (Top View)

Pin Definitions

Pin Name	Description
EN	Enable control. Pull high to turn on. Do not float.
AGND	Analog Ground
PGND	Power Ground
LX	Inductor pin. Connect this pin to the switching node of inductor.
VIN	Power Input
FB	Output Feedback Pin. Connect this pin to the center point of the output resistor divider (as shown in Figure 1) to program the output voltage: $V_{OUT}=0.6*(1+R1/R2)$. Add optional C1 (10pF~47pF) to speed up the transient response.



DIO6507

High-Efficiency 1A Output Synchronous Step Down Converter

Absolute Maximum Ratings

Stresses beyond those listed under “Absolute Maximum Rating” may cause permanent damage to the device. These are stress ratings only and functional operation of the device at these or any other condition beyond those indicated in the operational sections of the specifications is not implied. Exposure to absolute maximum rating conditions for extended periods may affect device reliability.

Parameter		Rating	Unit
Supply Voltage (V+ – V-)		6.5	V
Enable, FB Voltage		$V_{IN}+0.6$	V
Storage Temperature Range		-65 to 150	°C
P _D , Power Dissipation		700	mW
Lead Temperature Range		260	°C
ESD	HBM, JEDEC: JESD22-A114	4000	V
Dynamic LX Voltage in 50ns Duration		$V_{IN}+3$ to GND-4	V

Recommend Operating Conditions

The Recommended Operating Conditions table defines the conditions for actual device operation. Recommended Operating conditions are specified to ensure optimal performance to the datasheet specifications. DIOO does not Recommend exceeding them or designing to Absolute Maximum Ratings.

Parameter	Rating	Unit
Supply Voltage	2.5 to 5.9	V
Ambient Temperature Range	-40 to 85	°C





DIO6507

High-Efficiency 1A Output Synchronous Step Down Converter

Electrical Characteristics

$V_{IN} = 5V$, $V_{OUT} = 1.8V$, $L = 2.2\mu H$, $C_{OUT} = 10\mu F$, $T_A = 25^\circ C$, unless otherwise specified.

Symbol	Parameter	Test Conditions	Min	Typ	Max	Unit
V_{IN}	Input Voltage Range		2.5		5.9	V
I_Q	Quiescent Current	$I_{OUT}=0$		40		μA
I_{SHDN}	Shutdown Current	$EN=0$		0.1	1	μA
V_{REF}	Feedback Reference Voltage		0.588	0.6	0.612	V
$\Delta V_{REF}/\Delta T$	Feedback Output Voltage Temperature Coefficient	$-40^\circ C \leq T_a \leq 85^\circ C$		± 100		ppm/ $^\circ C$
$R_{DS(ON),P}$	PFET R_{ON}			230		m Ω
$R_{DS(ON),N}$	NFET R_{ON}			170		m Ω
V_{ENH}	EN Rising Threshold		1.5			V
V_{ENL}	EN Falling Threshold				0.4	V
V_{UVLO}	Input UVLO Threshold				2.4	V
V_{HYS}	UVLO Hysteresis			0.3		V
F_{OSC}	Oscillator Frequency	$I_{OUT}=500mA$,		1.5		MHz
	Min ON Time			80		ns
T_{SS}	Soft Start Time			1		ms
T_{SD}	Thermal Shutdown Temperature			145		$^\circ C$
T_{HYS}	Thermal Shutdown Hysteresis			20		$^\circ C$

Typical Application

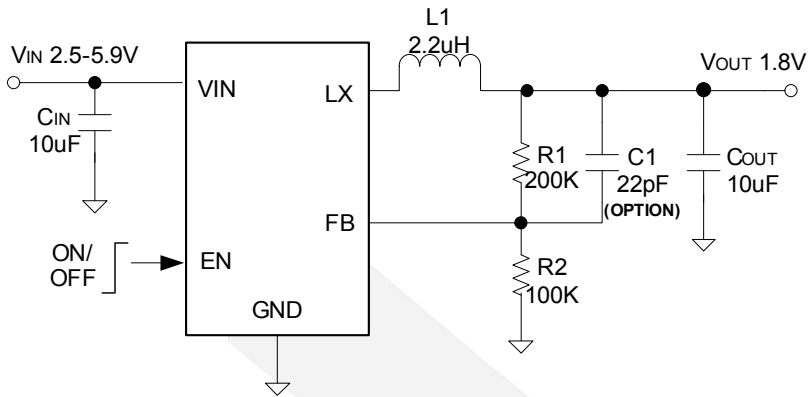

Typical Performance Characteristics

$V_{IN} = 5V$, $V_{OUT} = 1.8V$, $L = 2.2\mu H$, $C_{IN} = 10\mu F$, $C_{OUT} = 10\mu F$, $T_A = 25^\circ C$, unless otherwise noted.

Efficiency vs. ILoad

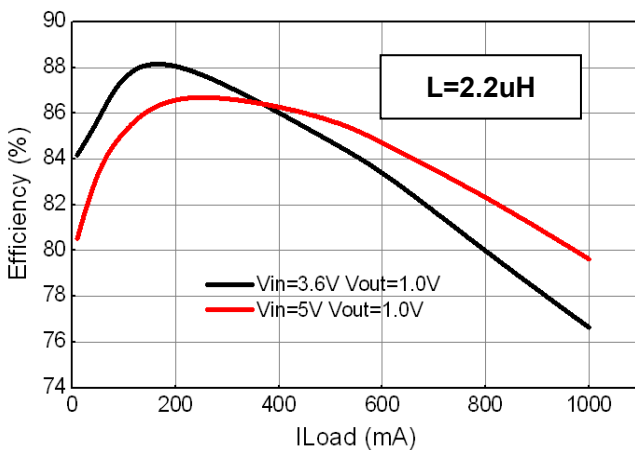

Efficiency vs. ILoad

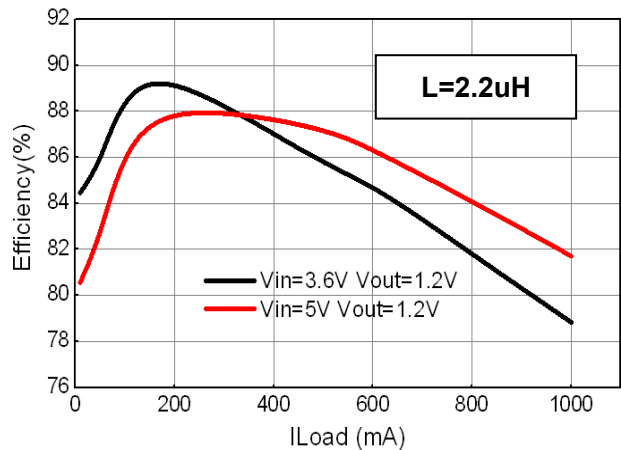

Efficiency vs. ILoad

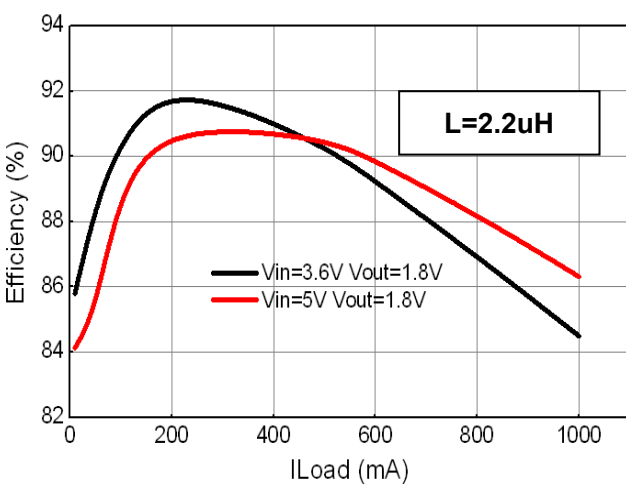

Efficiency vs. ILoad

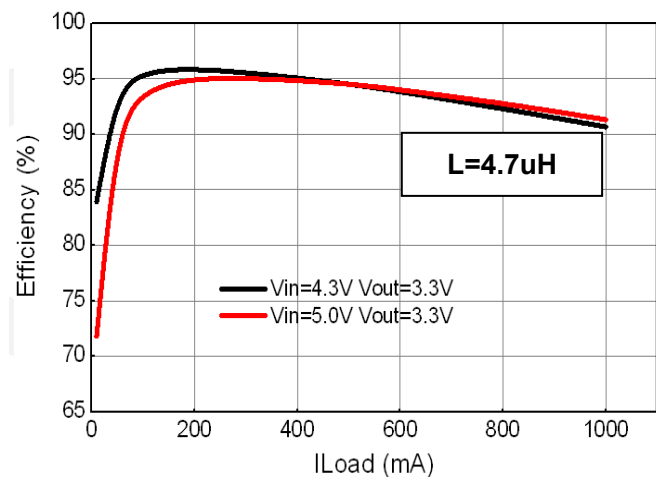

Startup from Vin
Vin=5V Vout=1.8V Load=1A

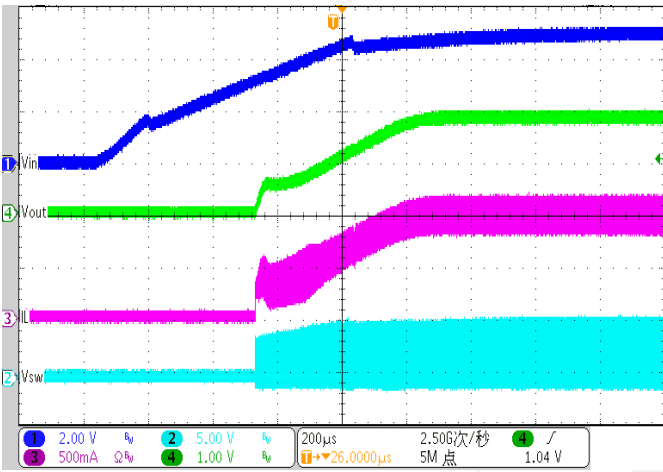

Shutdown from Vin
Vin=5V Vout=1.8V Load=1A

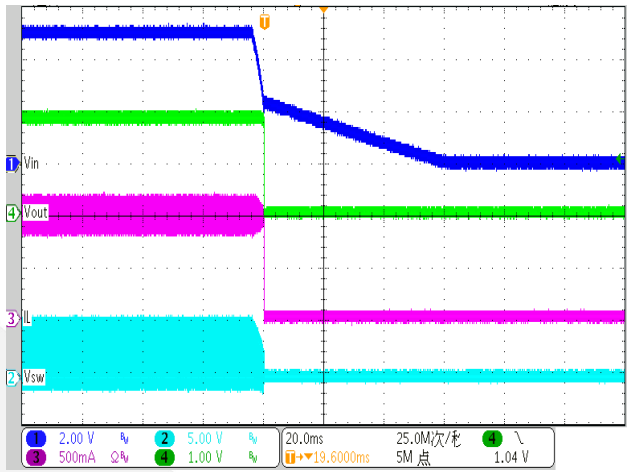

Startup from Enable
Vin=5V Vout=1.8V Load=1A

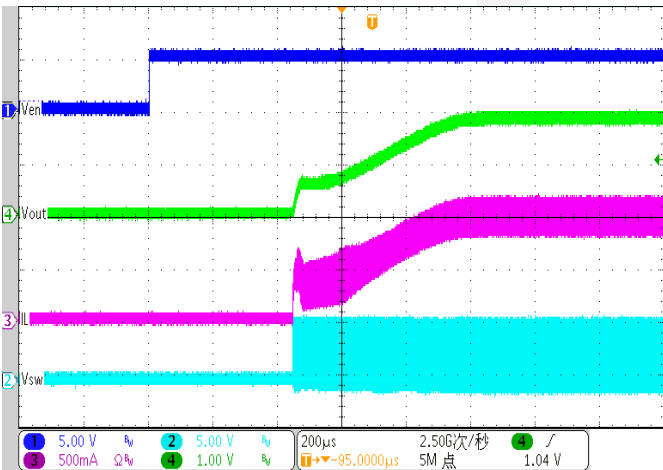

Shutdown from Enable
Vin=5V Vout=1.8V Load=1A

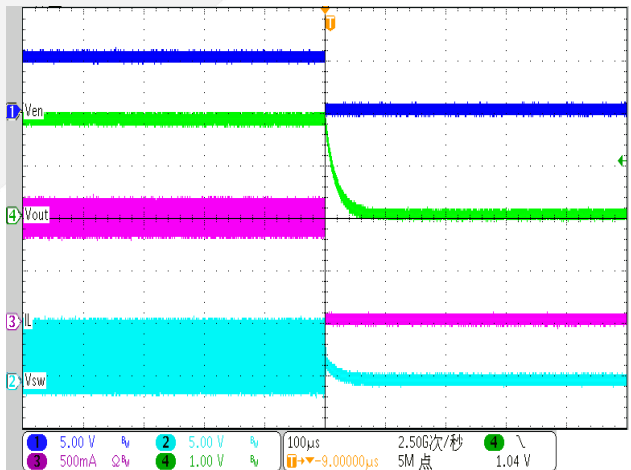

Ripple
Vin=5V Vout=1.8V Load=0A

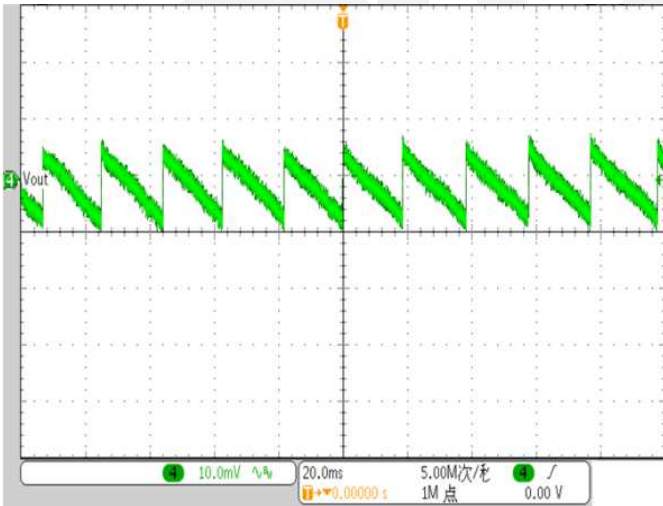

Ripple
Vin=5V Vout=1.8V Load=1A

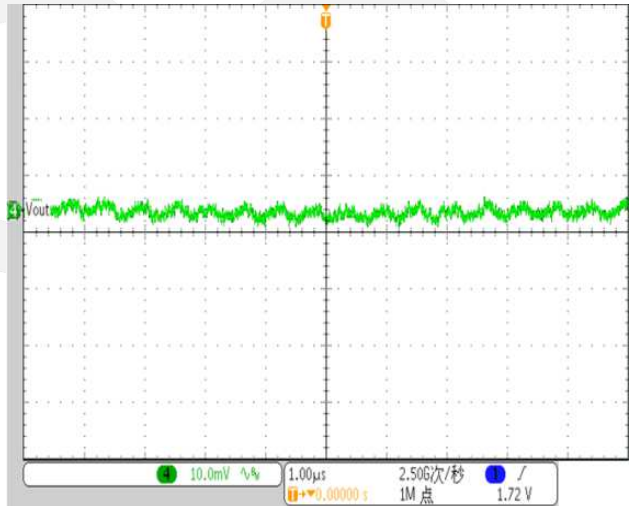

Load transient
Vin=5V Vout=1.8V Load=0.1->1A

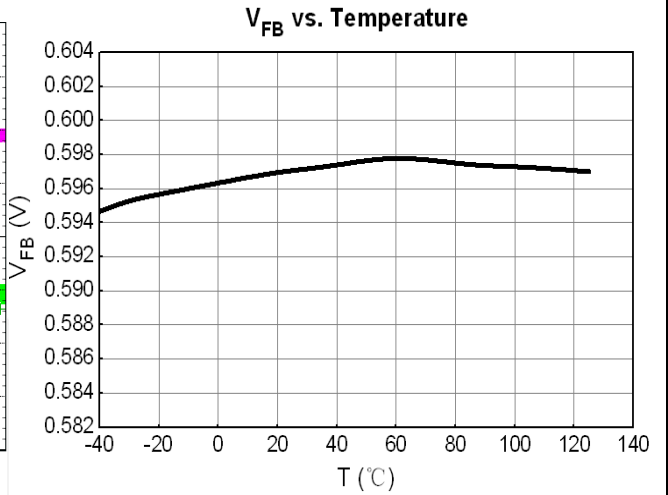
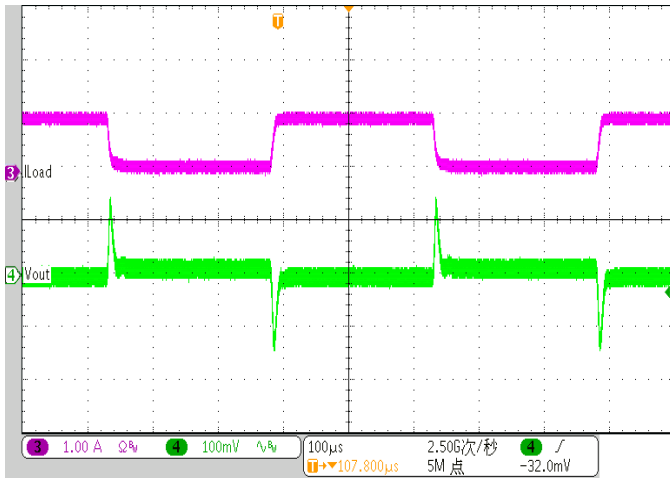

CONTACT US

Dioo is a professional design and sales corporation for high-quality and performance analog semiconductors. The company focuses on industry markets, such as, cell phone, handheld products, laptop, and medical equipment and so on. Dioo's product families include analog signal processing and amplifying, LED drivers and charger IC. Go to <http://www.dioo.com> for a complete list of Dioo product families.

For additional product information, or full datasheet, please contact with our Sales Department or Representatives.

A large, light gray watermark of the Dioo logo is centered on the page. It consists of a stylized arrow pointing right above the word "dioo" in a lowercase, sans-serif font.

X-ON Electronics

Largest Supplier of Electrical and Electronic Components

Click to view similar products for [Switching Voltage Regulators](#) category:

Click to view products by [Dioo](#) manufacturer:

Other Similar products are found below :

[FAN53610AUC33X](#) [FAN53611AUC123X](#) [FAN48610BUC33X](#) [FAN48610BUC45X](#) [FAN48617UC50X](#) [R3](#) [430464BB](#) [KE177614](#)
[FAN53611AUC12X](#) [MAX809TTR](#) [NCV891234MW50R2G](#) [NCP81103MNTXG](#) [NCP81203PMNTXG](#) [NCP81208MNTXG](#)
[NCP81109GMNTXG](#) [SCY1751FCCT1G](#) [NCP81109JMNTXG](#) [AP3409ADNTR-G1](#) [NCP81241MNTXG](#) [LTM8064IY](#) [LT8315EFE#TRPBF](#)
[LTM4664EY#PBF](#) [LTM4668AIY#PBF](#) [NCV1077CSTBT3G](#) [XCL207A123CR-G](#) [MPM54304GMN-0002](#) [MPM54304GMN-0004](#)
[MPM54304GMN-0003](#) [AP62300Z6-7](#) [MP8757GL-P](#) [MIC23356YFT-TR](#) [LD8116CGL](#) [HG2269M/TR](#) [OB2269](#) [XD3526](#) [U6215A](#) [U6215B](#)
[U6620S](#) [LTC3412IFE](#) [LT1425IS](#) [MAX25203BATJA/VY+](#) [MAX77874CEWM+](#) [XC9236D08CER-G](#) [MP3416GJ-P](#) [MP5461GC-Z](#)
[MPQ4590GS-Z](#) [MAX38640BENT18+T](#) [MAX77511AEWB+](#) [MAX20406AFOD/VY+](#) [MAX20408AFOC/VY+](#)