

# DIO6602

## Low I<sub>Q</sub> High Light Load Efficiency Synchronous Boost Converter

### Features

- Deliver 3.3V at 60mA from a Single Alkaline/Ni-MH or 3.3V at 120mA from Two Cells
- Up to 94% Efficiency
- Low Shutdown Current: < 1 $\mu$ A
- Low Quiescent Current: 12 $\mu$ A
- Low No-load Input Current
- Output Disconnect by Shutdown Function
- SOT23-6 Package

### Applications

- Wireless Mice
- Medical Instruments
- Smart Phones
- Bluetooth Devices

### Descriptions

The DIO6602 is a synchronous step-up DC/DC converter. That is base on constant Off Time/PSM controller topology. The IC enters PSM mode automatically at light load, the goal is to improve efficiency and reduce quiescent current. The DIO6602 provide a complete power supply solution for products powered by one or two Alkaline, Ni-Cd, or Ni-MH battery cells. It stays in operation with supply voltages down to 0.7V. The implemented boost converter is based on a constant Off Time/PSM controller topology using an internal synchronous rectifier to obtain maximum efficiency. A low-EMI mode is implemented to reduce ringing and in effect lower radiated electromagnetic energy when the converter enters the discontinuous conduction mode.

### Function Block

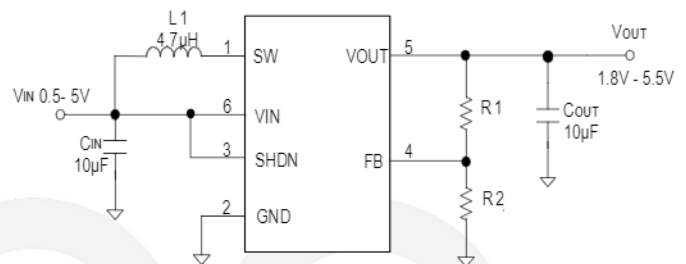

### Ordering Information

Order Part Number	Top Marking		T <sub>A</sub>	Package	
DIO6602ST6	W602	Green	-40 to 85°C	SOT23-6	Tape & Reel, 3000

## Pin Assignments

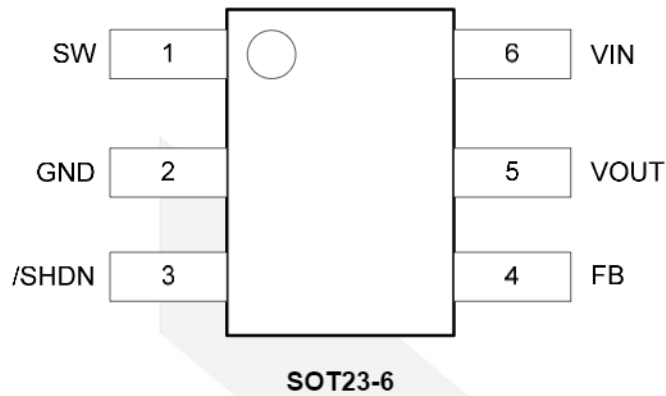
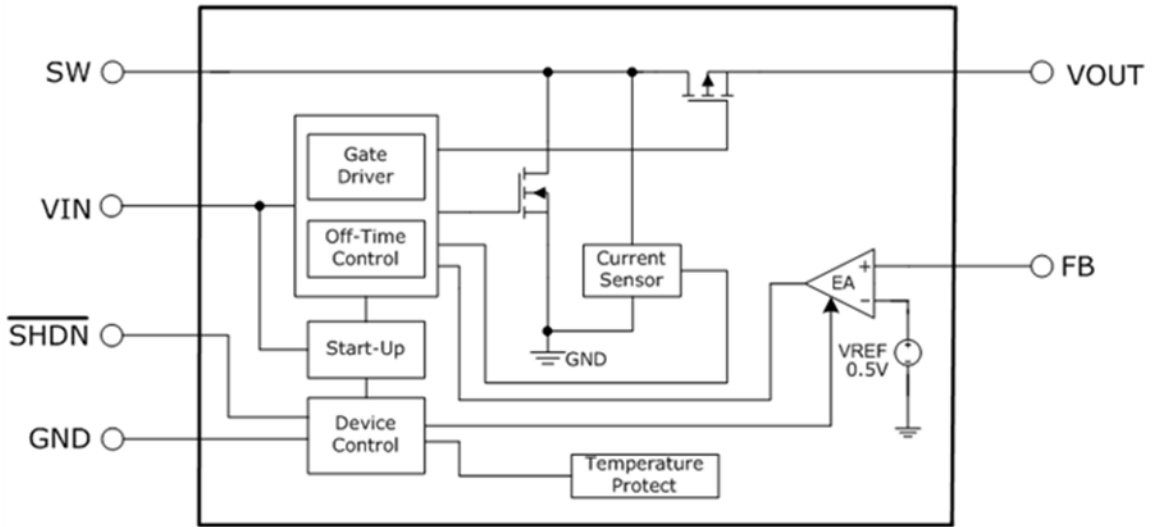

**Figure 1 Pin Assignment (Top View)**

## Pin Definitions

Pin Name	Description
SW	Switch Pin. Connect Inductor between VIN and this pin.
GND	Power Ground
/SHDN	Logic Controlled Shutdown Input. /SHDN= High: Normal Operation; /SHDN= Low: IC Shutdown;
FB	Feedback Input to Error Amplifier. Connect resistor divider tap to this pin.
VOUT	Output Voltage Sense and Drain of the Internal Synchronous Rectifier.
VIN	Input Supply Pin.

## Function Block Diagram



## Absolute Maximum Ratings

Stresses beyond those listed under "Absolute Maximum Rating" may cause permanent damage to the device. These are stress ratings only and functional operation of the device at these or any other condition beyond those indicated in the operational sections of the specifications is not implied. Exposure to absolute maximum rating conditions for extended periods may affect device reliability.

Parameter	Rating	Unit
FB, /SHDN, OUT, VIN Voltage	-0.3 to 6	V
SW Voltage	DC	-0.3 to 6
	Pulsed < 100ns	-0.3 to 7
Operating Ambient Temperature Range T <sub>A</sub>	-40 to 85	°C
Operating Maximum Junction Temperature Range T <sub>J</sub>	150	°C
Storage Temperature Range T <sub>STG</sub>	-65 to 150	°C
Lead Temperature Range	260	°C
Thermal Resistance Junction to Ambient	250	°C/W



# DIO6602

Low I<sub>Q</sub> High Light Load Efficiency Synchronous Boost Converter

## Electrical Characteristics

V<sub>IN</sub>=1.2V, V<sub>OUT</sub>=1.2V, V<sub>OUT</sub>=3.3V, T<sub>A</sub>=25°C unless otherwise specified.

Symbol	Parameter	Test Conditions	Min	Typ	Max	Unit
V <sub>OUT</sub>	Output Voltage Range		1.8		5.5	V
	Minimum Start Up Voltage	R <sub>L</sub> = 3.3kOhm		0.75	0.9	V
	Input Operation Voltage		0.7		5	V
	UVLO of V <sub>IN</sub>	V <sub>IN</sub> decreasing		0.5	0.7	V
I <sub>Q</sub>	Quiescent Current (PSM)	V <sub>OUT</sub> V <sub>IN</sub> =1.2V, V <sub>OUT</sub> =3.3V, V <sub>FB</sub> =0.55V		12	25	μA
I <sub>SD</sub>	IC Shut Down Current	/SHDN=0V, V <sub>OUT</sub> =1.1V		0.01	1	μA
F	Oscillator Frequency			1.0		MHz
V <sub>FB</sub>	Feedback Voltage		490	500	510	mV
I <sub>FB</sub>	FB Input Leakage Current	V <sub>FB</sub> =1.3V		1	50	nA
I <sub>LH</sub>	Inductor current ripple			200		mA
T <sub>OFF</sub>	Constant off time	V <sub>IN</sub> =1.2V, V <sub>OUT</sub> =3.3V		400		ns
	Line Regulation	V <sub>IN</sub> <V <sub>OUT</sub>		0.5%		
	Load Regulation	V <sub>IN</sub> <V <sub>OUT</sub>		0.5%		
	NMOS Switch Leakage	V <sub>SW</sub> =5V		0.1	5	μA
	PMOS Switch Leakage	V <sub>SW</sub> =5V, V <sub>OUT</sub> =0V		0.1	10	μA
	NMOS Switch On Resistance	V <sub>IN</sub> =1.2V, V <sub>OUT</sub> =3.3V		250		mΩ
	PMOS Switch On Resistance	V <sub>IN</sub> =1.2V, V <sub>OUT</sub> =3.3V		350		mΩ
	/SHDN High Threshold Voltage	V <sub>IN</sub> =1.2V	0.8			V
	/SHDN Low Threshold Voltage	V <sub>IN</sub> =1.2V			0.2	V
I <sub>SHDN</sub>	/SHDN Pin Input Current	/SHDN=5.5V		0.01	1.0	μA
	NMOS Current Limit	V <sub>IN</sub> =1.2V, V <sub>OUT</sub> =3.3V		0.75		A
	Over Temperature Protection			150		°C
	Over Temperature Hysteresis			30		°C

Specifications subject to change without notice.

## Typical Performance Characteristic

V<sub>IN</sub>=1.2V, V<sub>OUT</sub>=3.3V, L=4.7uH, C<sub>IN</sub>=C<sub>OUT</sub>=10uF, T<sub>A</sub>=25°C, unless otherwise specified.

**Efficiency Versus Output Current and Input Voltage**

V<sub>out</sub>=3V

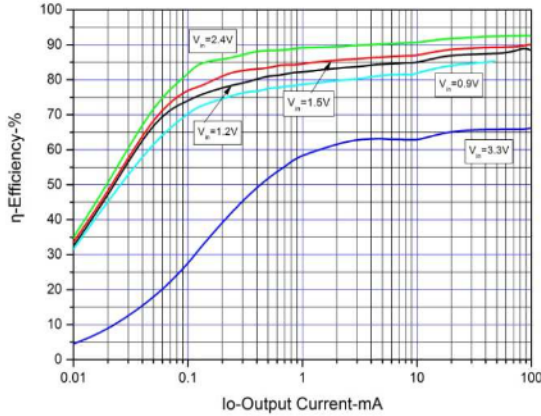

**No Load Input Current versus Input Voltage**

Device Enabled

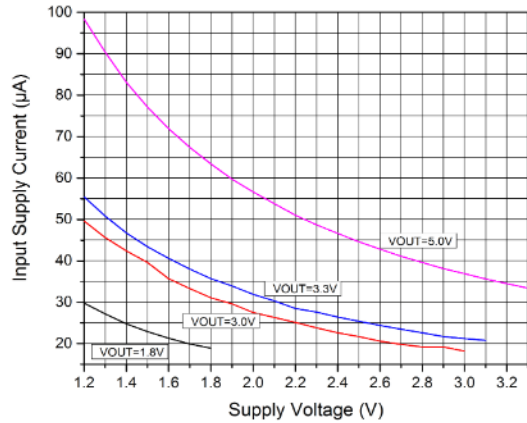

**VIN start**

Vin=0.7V Vout=3.3V Rload=1KΩ

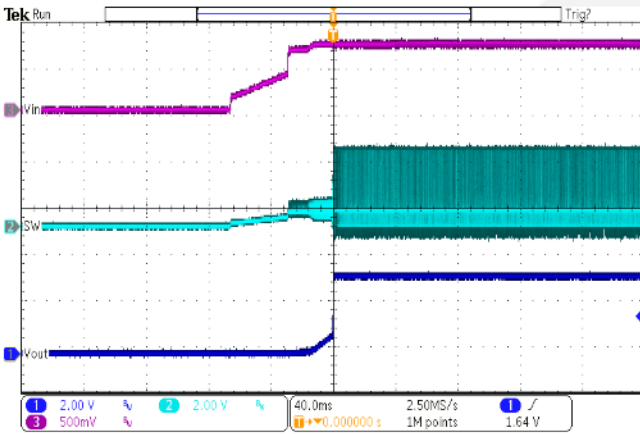

**VIN drop**

Vin=0.7V Vout=3.3V Rload=1KΩ

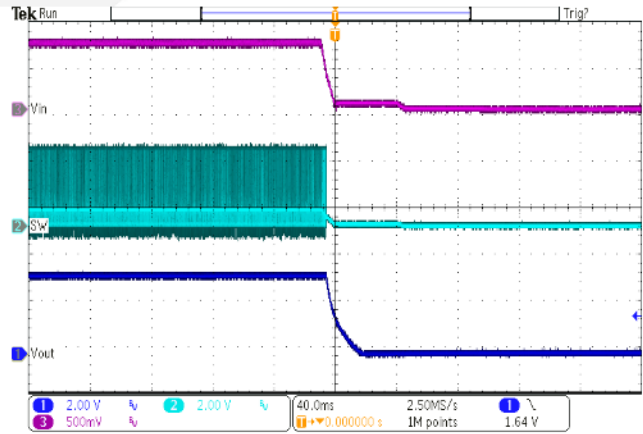

**VEN start up**

Vin=1.2V Vout=3.3V Rload=22Ω

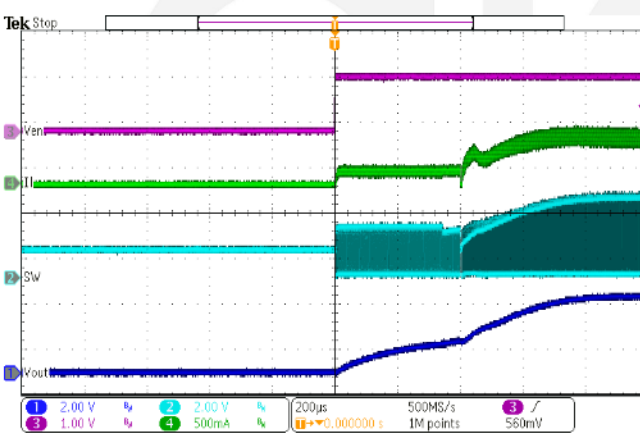

**VEN drop**

Vin=1.2V Vout=3.3V Rload=22Ω

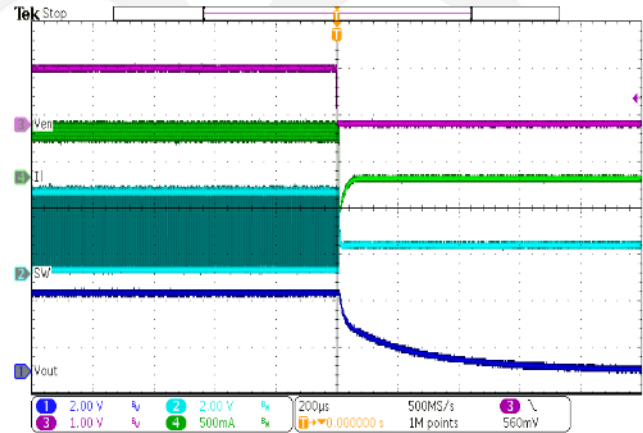

**Load transient**  
Vin=1.2V, Vout=3.3V, 0A~150mA

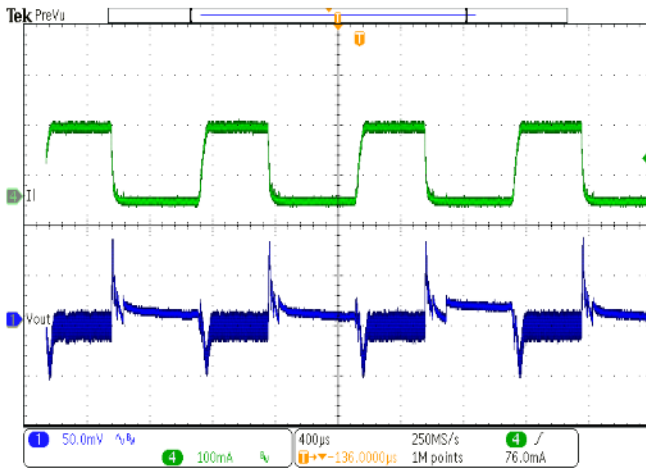

**Load transient**  
Vin=1.2V, Vout=3.3V, 30mA~150mA

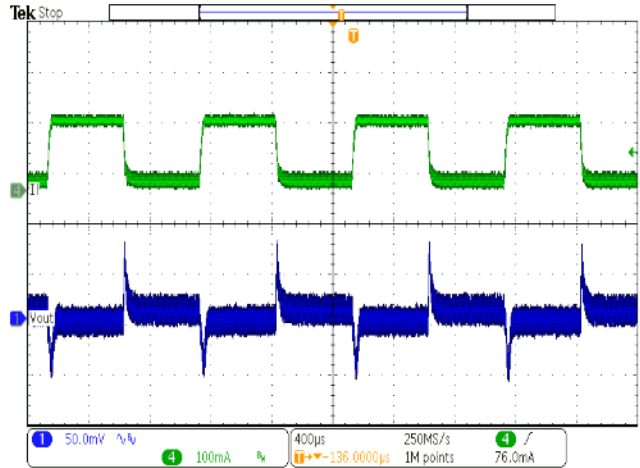

**Ripple**  
Vin=1.2V Vout=3.3V Iload=0A

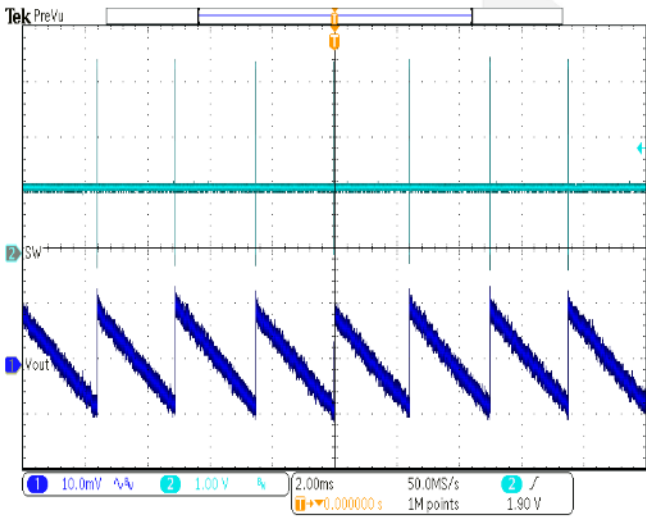

**Ripple**  
Vin=1.2V Vout=3.3V Iload=150mA

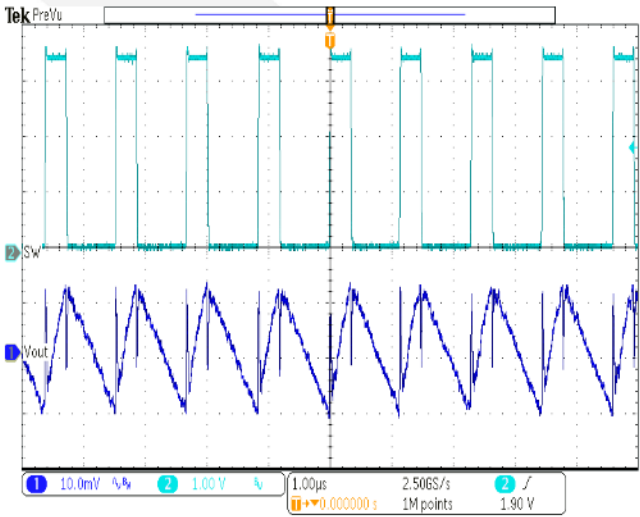

**Short Circuit Protection**  
Vin=1.2V Vout=3.3V Load=22Ω->short

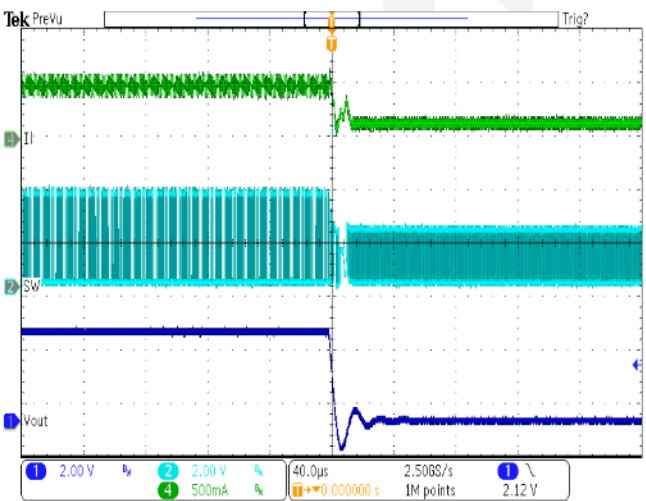

**Short Circuit Recovery**  
Vin=1.2V Vout=3.3V short -> Load=22Ω

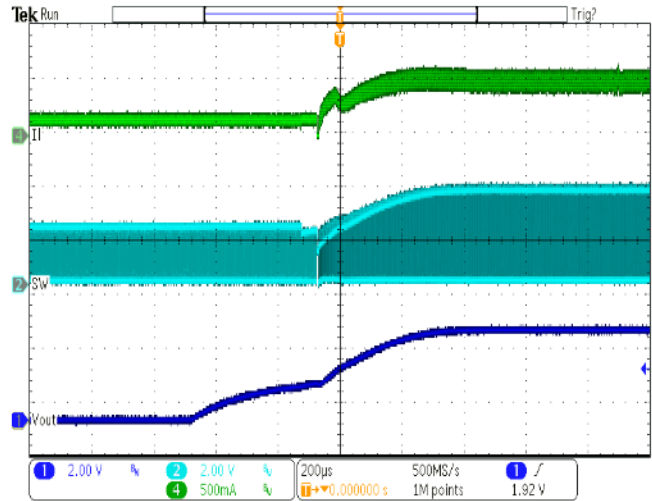

## Applications Information

The DIO6602 is a synchronous step-up DC-DC converter. It is based on constant Off Time/PSM controller topology. At the beginning of each clock cycle, the main switch (NMOS) is turned on and the inductor current starts to ramp. After the sense current signal equals the error amplifier (EA) output, the main switch is turned off and the synchronous switch (PMOS) is turned on. The device can operate with an input voltage below 1V; the typical start-up voltage is 0.75V.

### Current Limit

The over current protection is to limit the switch current. The output Voltage will be dropped when over current is happened. The current limit amplifier will turn off switch once the current exceeds its threshold.

### Zero Current Comparator

The zero current comparator monitors the inductor current to the output and shuts off the synchronous rectifier, This prevents the inductor current from reversing in polarity improving efficiency at light loads.

### Device Shutdown

When /SHDN is set logic high, the DIO6602 is put into active mode operation. If /SHDN is set logic low, the device is put into shutdown mode and consumes less than 1 $\mu$ A of current. At the shutdown mode, the synchronous switch will turn off and the output voltage of DIO6602 step-up converter will reduce to 0V. After start-up, the internal circuitry is supplied by V<sub>OUT</sub>, however, if shutdown mode is enabled, the internal circuitry will be supplied by the input source again.

### Adjustable Output Voltage

An external resistor divider is used to set the output voltage. The output voltage of the switching regulator (V<sub>OUT</sub>) is determined by the following equation:

$$V_{OUT} = V_{FB} \cdot \left( 1 + \frac{R_1}{R_2} \right)$$

Where V<sub>FB</sub> is 0.5V reference voltage.

### Input Inductor Selection

A 2.2 $\mu$ H~6.8 $\mu$ H input inductor is commanded for most DIO6602 applications. The 4.7 $\mu$ H input inductor can get the good performance over the whole converter ratio cases. The inductor which is smaller than 2.2 $\mu$ H is not recommended to use. It is important to ensure the inductor saturation current exceeding the peak inductor current in application to prevent core saturation.

### Input Capacitor Selection

Surfaces mount 4.7 $\mu$ F or greater, X5R or X7R, ceramic capacitor is suggested for the input capacitor. The input capacitor provides a low impedance loop for the edges of pulsed current drawn by the DIO6602. Low ESR/ESL X7R and X5R ceramic capacitors are ideal for this function. To minimize stray inductance, the capacitor should be placed as close as possible to the IC. This keeps the high frequency content of the input current localized, minimizing EMI and input voltage ripple. Always examine the ceramic capacitor DC voltage coefficient characteristics to get the proper value.

## Output Capacitor Selection

The output capacitor limits the output ripple and provides holdup during large load transitions. A 4.7 $\mu$ F to 10 $\mu$ F, X5R or X7R, ceramic capacitor is suggested for the output capacitor. Typically the recommended capacitor range provides sufficient bulk capacitance to stabilize the output voltage during large load transitions and has the low ESR and ESL characteristics necessary for low output voltage ripple.

## PCB Layout Guidance

This is a considerably high frequency for DC-DC converters. PCB layout is important to guarantee satisfactory performance. It is recommended to make traces of the power loop, especially where the switching node is involved, as short and wide as possible. First of all, the inductor, input and output capacitor should be as close as possible to the device. Feedback and shutdown circuits should avoid the proximity of large AC signals involving the power inductor and switching node.





## CONTACT US

Dioo is a professional design and sales corporation for high-quality and performance analog semiconductors. The company focuses on industry markets, such as, cell phone, handheld products, laptop, and medical equipment and so on. Dioo's product families include analog signal processing and amplifying, LED drivers and charger IC. Go to <http://www.dioo.com> for a complete list of Dioo product families.

For additional product information, or full datasheet, please contact with our Sales Department or Representatives.

A large, light gray watermark of the Dioo logo is centered on the page. It consists of a stylized arrow pointing right, followed by the word "dioo" in a lowercase, sans-serif font.

## X-ON Electronics

Largest Supplier of Electrical and Electronic Components

*Click to view similar products for [Isolated DC/DC Converters](#) category:*

*Click to view products by [Dioo](#) manufacturer:*

Other Similar products are found below :

[ESM6D044440C05AAQ](#) [FMD15.24G](#) [PSL486-7LR](#) [PSR152.5-7IR](#) [Q48T30020-NBB0](#) [AVO240-48S12B-6L](#) [AVO250-48S28B-6L](#) [NAN-0505](#) [HW-L16D](#) [JAHW100Y1](#) [217-1617-001](#) [22827](#) [SPB05C-12](#) [SQ24S15033-PS0S](#) [18952](#) [19-130041](#) [CE-1003](#) [CE-1004](#) [GQ2541-7R](#) [PSE1000DCDC-12V](#) [RDS180245](#) [MAU228](#) [419-2065-201](#) [449-2075-101](#) [J80-0041NL](#) [V300C24C150BG](#) [419-2062-200](#) [419-2063-401](#) [419-2067-101](#) [419-2067-501](#) [419-2068-001](#) [DCG40-5G](#) [DFC15U48D15](#) [449-2067-000](#) [XGS-0512](#) [XGS-1205](#) [XGS-1212](#) [XGS-2412](#) [XGS-2415](#) [XKS-1215](#) [033456](#) [NCT1000N040R050B](#) [SPB05B-15](#) [SPB05C-15](#) [SSQE48T25025-NAA0G](#) [L-DA20](#) [HP3040-9RG](#) [HP1001-9RTG](#) [XKS-2415](#) [XKS-2412](#)