

# DIP SWITCH DHN(F) SERIES

1.6mm  
Half Pitch Type

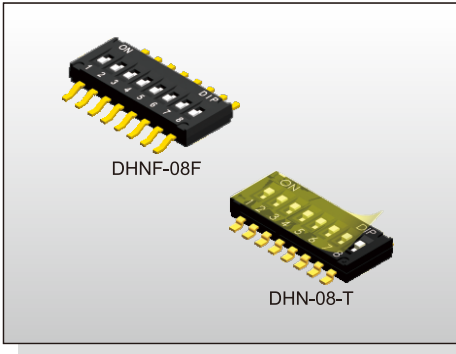

## FEATURES

- ※Low profile 1.6mm height
- ※Gold contact for high reliability
- ※Top tape type for washing process

## APPLICATION

- ※Industrial control
- ※Automatic machines control
- ※NB, electronic devices

## SPECIFICATION

Contact Rating	25mA, 24V DC
Contact Resistance	100mΩ max.
Insulation Resistance	100MΩ min. 500V DC
Dielectric Strength	300V AC/1 minute
Operating Force	500gf max.
Travel	0.6mm
Operating Life	1,000 cycles
Operating Temp.	-40°C ~ +85°C
Storage Temp.	-40°C ~ +85°C

## HOW TO ORDER

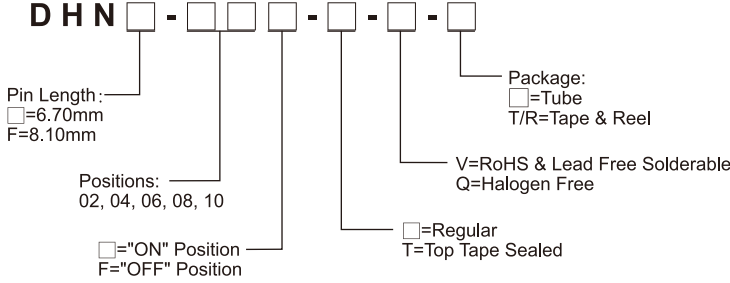

## CIRCUIT

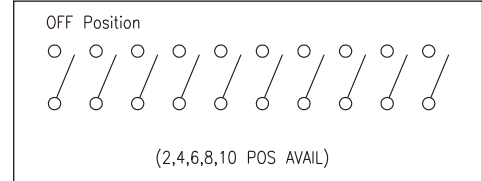

## PACKAGE

- <Tube>  
 DHN(F)-02: 125 pcs  
 DHN(F)-04: 75 pcs  
 DHN(F)-06: 54 pcs  
 DHN(F)-08: 40 pcs  
 DHN(F)-10: 33 pcs
- <Tape & Reel>  
 DHN: 4000 pcs  
 DHNF: 2500 pcs

## DHN

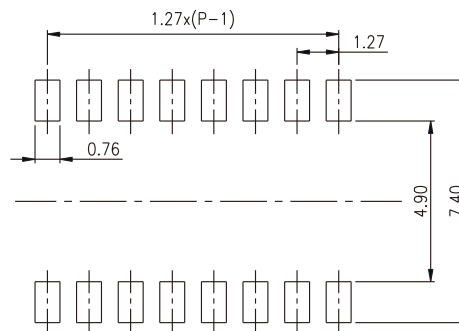
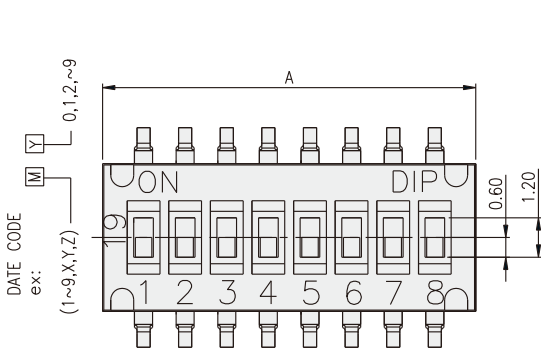

P.C.B. LAYOUT

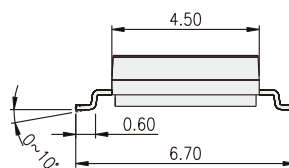
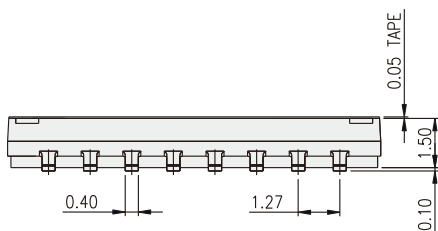

PART NO.	NO.OF POS	DIM A
DHN-02	2	3.77
DHN-04	4	6.31
DHN-06	6	8.85
DHN-08	8	11.39
DHN-10	10	13.93

DHNF

DIP SWITCH

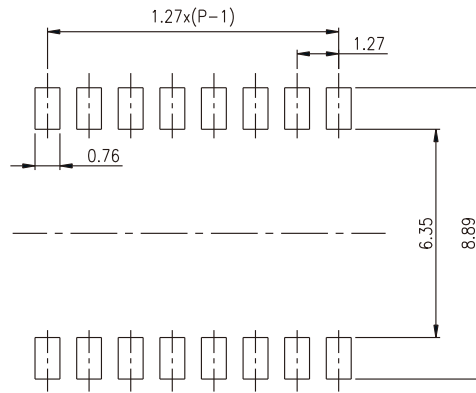
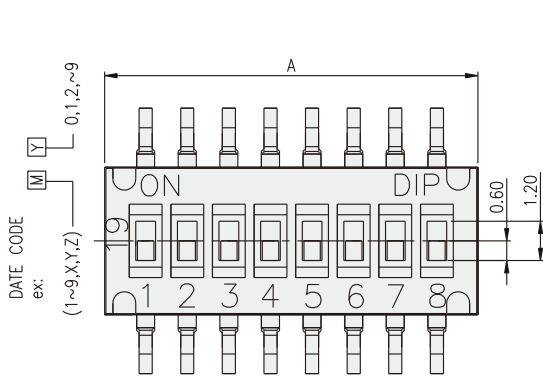

P.C.B. LAYOUT

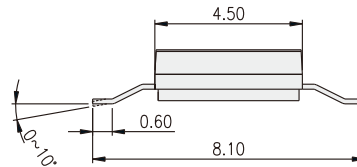
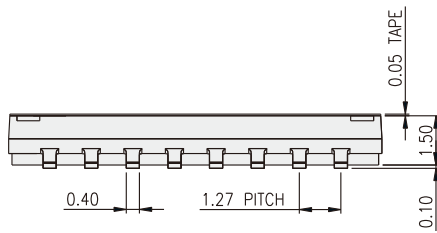

PART NO.	NO.OF POS	DIM A
DHNF-02	2	3.77
DHNF-04	4	6.31
DHNF-06	6	8.85
DHNF-08	8	11.39
DHNF-10	10	13.93

## X-ON Electronics

Largest Supplier of Electrical and Electronic Components

*Click to view similar products for [DIP Switches/SIP Switches](#) category:*

*Click to view products by [Diptronics](#) manufacturer:*

Other Similar products are found below :

[78M03S](#) [79B10T](#) [8136-475G4T](#) [G7G-1A2-CB-DC12](#) [A7SS-M](#) [DBP 2110](#) [DBP 2112](#) [DBS1008](#) [DHN02FTVTR](#) [DHN10T](#) [DHS108](#)  
[DPL08TN](#) [DRD16CSE04](#) [DRR4010](#) [DRR60016](#) [DRS4016](#) [BD06E](#) [1825008-1](#) [1825444-1](#) [25.350.0653.0](#) [LA2-DC12](#) [SBS 5004 TG](#)  
[SDA10H1BDA](#) [97R06ST](#) [A2C-2A5](#) [1825444-7](#) [ADE08SA04](#) [ADE12S04](#) [2161391-1](#) [2-1825058-8](#) [CCVA 2.5/ 4-G-5.08](#) [P26THRR32](#)  
[25.330.0653.1](#) [25.352.0353.0](#) [MDG305ST](#) [IKN0600000](#) [IKN0800000](#) [LA2-002-DC24](#) [DBP2008](#) [DBS1003](#) [DBS2008](#) [438872000](#)  
[DRD10CRAE04](#) [DRS1604](#) [DSR02T](#) [DSS 208 N](#) [5-1825033-1](#) [106-SDN06-EV](#) [1-1437507-6](#) [E2FMX2D1M1TGJ03M](#)  
[E3ZMCT81M1TJ03M](#)