

DIP SWITCH DHN(F) SERIES

1.6mm
Half Pitch Type

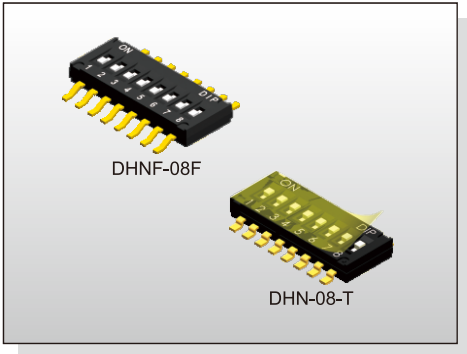

FEATURES

- ※Low profile 1.6mm height
- ※Gold contact for high reliability
- ※Top tape type for washing process

APPLICATION

- ※Industrial control
- ※Automatic machines control
- ※NB, electronic devices

SPECIFICATION

Contact Rating	25mA, 24V DC
Contact Resistance	100mΩ max.
Insulation Resistance	100MΩ min. 500V DC
Dielectric Strength	300V AC/1 minute
Operating Force	500gf max.
Travel	0.6mm
Operating Life	1,000 cycles
Operating Temp.	-40°C ~ +85°C
Storage Temp.	-40°C ~ +85°C

HOW TO ORDER

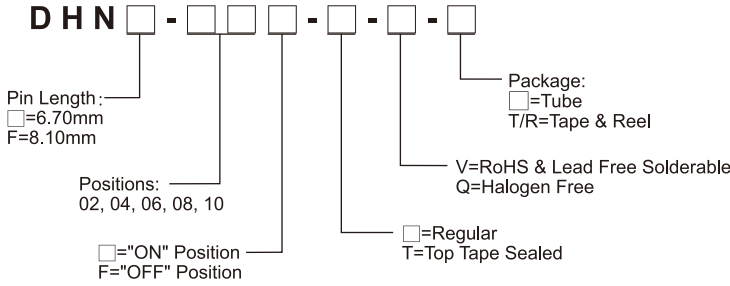

CIRCUIT

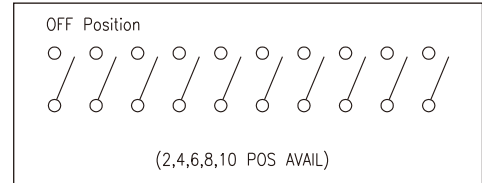

PACKAGE

- <Tube>
 DHN(F)-02: 125 pcs
 DHN(F)-04: 75 pcs
 DHN(F)-06: 54 pcs
 DHN(F)-08: 40 pcs
 DHN(F)-10: 33 pcs
- <Tape & Reel>
 DHN: 4000 pcs
 DHNF: 2500 pcs

DHN

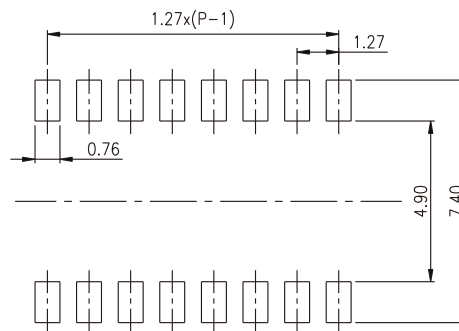
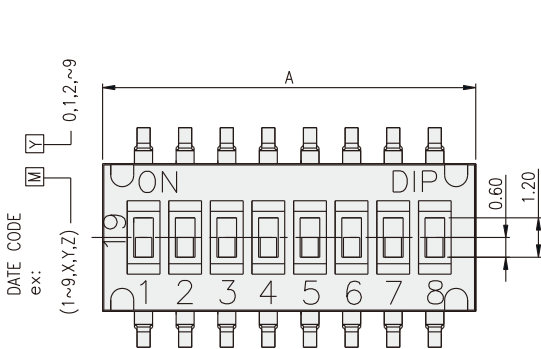

P.C.B. LAYOUT

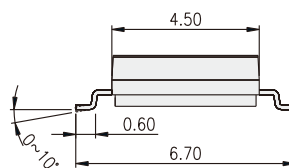
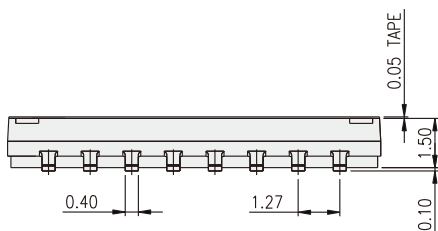

PART NO.	NO.OF POS	DIM A
DHN-02	2	3.77
DHN-04	4	6.31
DHN-06	6	8.85
DHN-08	8	11.39
DHN-10	10	13.93

DHNF

DIP SWITCH

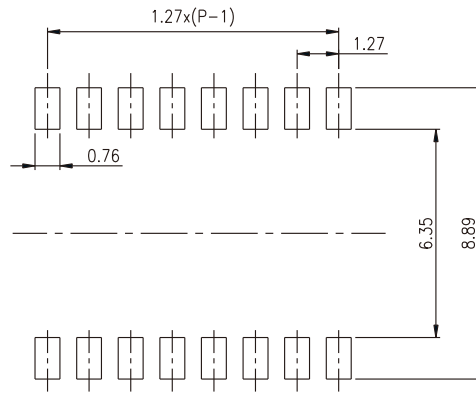
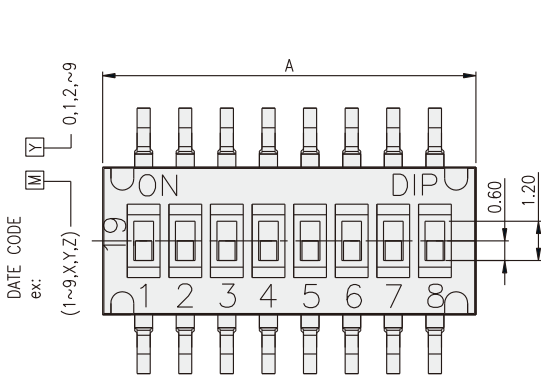

P.C.B. LAYOUT

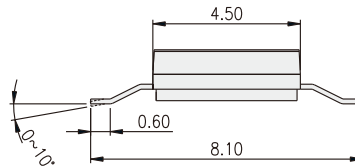
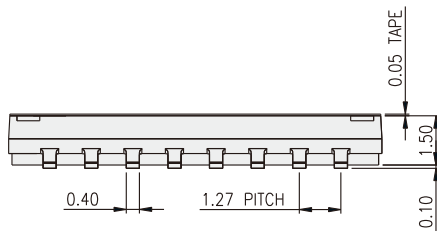

PART NO.	NO.OF POS	DIM A
DHNF-02	2	3.77
DHNF-04	4	6.31
DHNF-06	6	8.85
DHNF-08	8	11.39
DHNF-10	10	13.93

X-ON Electronics

Largest Supplier of Electrical and Electronic Components

Click to view similar products for [DIP Switches/SIP Switches](#) category:

Click to view products by [Diptronics](#) manufacturer:

Other Similar products are found below :

[79B10T](#) [8136-475G4T](#) [G7G-1A2-CB-DC12](#) [193005MS](#) [195010MS](#) [200183](#) [206002](#) [208004](#) [208007ST](#) [208008](#) [208012ST](#) [25.350.0653.0](#)
[SDA10H1BDA](#) [97R06ST](#) [A2C-2A5](#) [1825444-7](#) [ADE12S04](#) [192960010](#) [206005RAS](#) [206007](#) [209005LPST](#) [2-1825058-8](#) [219002LPST](#)
[219002MSTJRF](#) [219012MST](#) [25.352.0353.0](#) [CXDRIVEV2X](#) [LA2-002-DC24](#) [DSR02T](#) [193004MS](#) [E2FMX2D1M1TGJ03M](#) [NDI10H](#) [219-](#)
[9MSTP](#) [219008LPSTR](#) [EPM02FV](#) [206010RAST](#) [76SB05](#) [TD06H0SK1](#) [Z7.255.9027.0](#) [1-1825058-3](#) [1825428-4](#) [219-10LPSTF](#)
[E3ZG6111D03M](#) [G4D212PUSTV2DC5](#) [HARW0002](#) [NDI10S](#) [EPG301BT06](#) [1-1825058-6](#) [E3TSL23M5J03M](#) [7R0060](#)