

DIP SWITCH D(M)(J)(L) SERIES

SMT Type

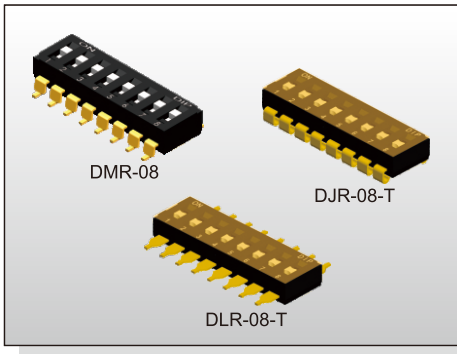

FEATURES

- ※ Low profile for space saving
- ※ Gold contact for high reliability
- ※ Top tape type for washing process

APPLICATION

- ※ Industrial control
- ※ Automatic machines control
- ※ Telecommunication

SPECIFICATION

Contact Rating	25mA, 24V DC
Contact Resistance	50mΩ max.
Insulation Resistance	100MΩ min. 500V DC
Dielectric Strength	500V AC/1 minute
Operating Force	1,000gf max.
Travel	1mm
Operating Life	2,000 cycles
Operating Temp.	-20°C ~ +85°C
Storage Temp.	-40°C ~ +85°C

CIRCUIT

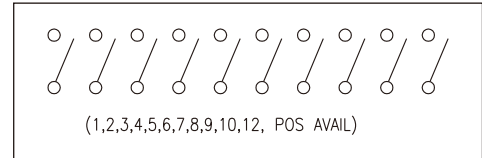

PACKAGE

<Tube>

DM(R), DJ(R):

- 01: 130 pcs 02: 76 pcs 03: 55 pcs 04: 42 pcs
- 05: 35 pcs 06: 28 pcs 07: 25 pcs 08: 22 pcs
- 09: 20 pcs 10: 18 pcs 12: 15 pcs

<Tape & Reel>

- DM(R)-01: 800 pcs
- DMR-02~DMR-12: 900 pcs
- DM-(01)(05)(07): 800 pcs
- DM-(02)(03)(04)(06)(08)(09)(10)(12): 700 pcs
- DJR-(02)(03)(04)(08)(09)(10): 1000 pcs

<Bag>

DL(R): 1000 pcs

HOW TO ORDER

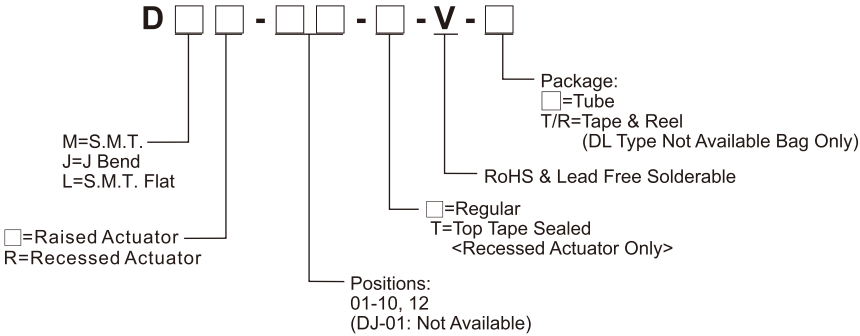

DM(R)

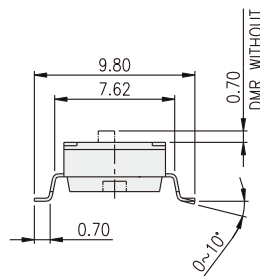
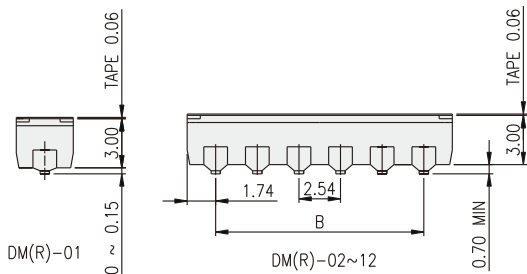
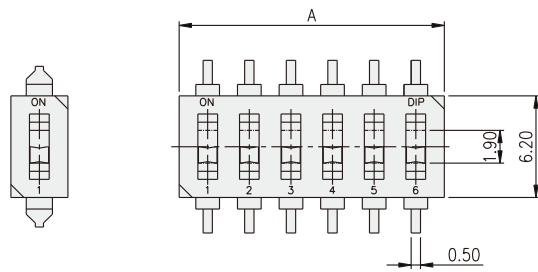

PART NO.	NO.OF POS.	DIM.A	DIM.B
DM(R)-01	1	3.48	
DM(R)-02	2	6.02	2.54
DM(R)-03	3	8.56	5.08
DM(R)-04	4	11.10	7.62
DM(R)-05	5	13.64	10.16
DM(R)-06	6	16.18	12.70
DM(R)-07	7	18.72	15.24
DM(R)-08	8	21.26	17.78
DM(R)-09	9	23.80	20.32
DM(R)-10	10	26.34	22.86
DM(R)-12	12	31.42	27.94

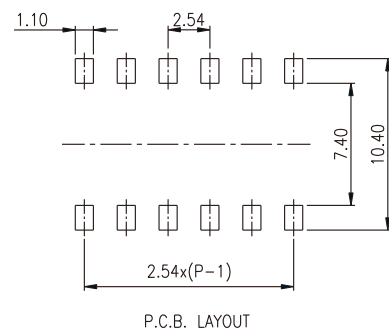

DJ(R)

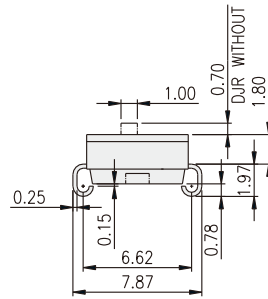
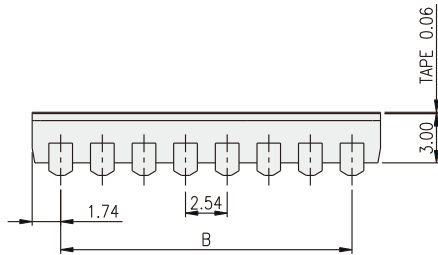
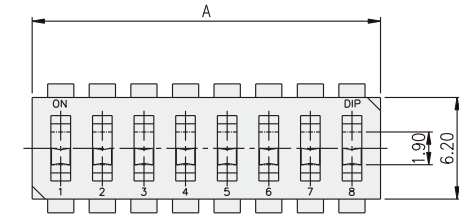

PART NO.	NO.OF POS.	DIM.A	DIM.B
DJ(R)-02	2	6.02	2.54
DJ(R)-03	3	8.56	5.08
DJ(R)-04	4	11.10	7.62
DJ(R)-05	5	13.64	10.16
DJ(R)-06	6	16.18	12.70
DJ(R)-07	7	18.72	15.24
DJ(R)-08	8	21.26	17.78
DJ(R)-09	9	23.80	20.32
DJ(R)-10	10	26.34	22.86
DJ(R)-12	12	31.42	27.94

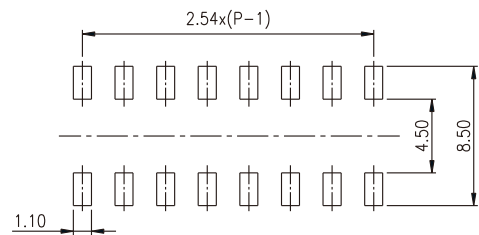

P.C.B. LAYOUT

DL(R)

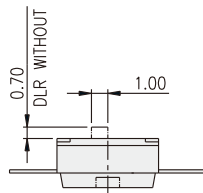
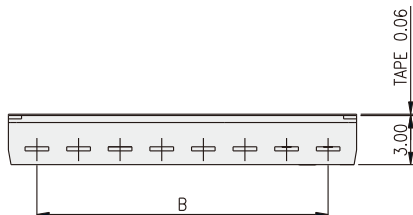
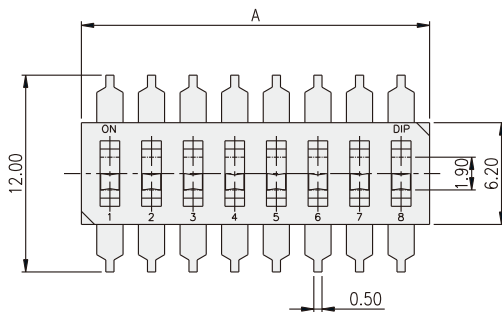

PART NO.	NO.OF POS.	DIM.A	DIM.B
DL(R)-01	1	3.48	
DL(R)-02	2	6.02	2.54
DL(R)-03	3	8.56	5.08
DL(R)-04	4	11.10	7.62
DL(R)-05	5	13.64	10.16
DL(R)-06	6	16.18	12.70
DL(R)-07	7	18.72	15.24
DL(R)-08	8	21.26	17.78
DL(R)-09	9	23.80	20.32
DL(R)-10	10	26.34	22.86
DL(R)-12	12	31.42	27.94

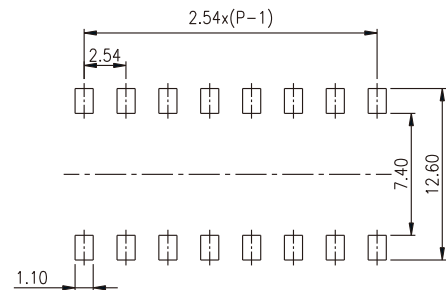

P.C.B. LAYOUT

X-ON Electronics

Largest Supplier of Electrical and Electronic Components

Click to view similar products for [DIP Switches/SIP Switches](#) category:

Click to view products by [Diptronics](#) manufacturer:

Other Similar products are found below :

[79B10T](#) [8136-475G4T](#) [G7G-1A2-CB-DC12](#) [H7CZL8AC100240](#) [DRR60016](#) [DRS4016](#) [1825008-1](#) [1825444-1](#) [200183](#) [206002](#) [219-6LPSTRF](#) [25.350.0653.0](#) [SBS 5004 TG](#) [SDA10H1BDA](#) [97R06ST](#) [A2C-2A5](#) [1825444-7](#) [ADE08SA04](#) [ADE12S04](#) [192960010](#) [206005RAS](#) [206007](#) [2-1825058-8](#) [25.330.0653.1](#) [25.352.0353.0](#) [CXDRIVEV2X](#) [IKN0600000](#) [IKN0800000](#) [LA2-002-DC24](#) [DRD10CRAE04](#) [DSR02T](#) [DSS 208 N](#) [E2FMX2D1M1TGJ03M](#) [NDI10H](#) [219-9MSTP](#) [EPM02FV](#) [206010RAST](#) [NDS08V](#) [76SB05](#) [TD06H0SK1](#) [Z7.255.9027.0](#) [1-1825058-3](#) [1825428-4](#) [219-10LPSTF](#) [E3ZG6111D03M](#) [G4D212PUSTV2DC5](#) [HARW0002](#) [EPG301BT06](#) [219-7LPSTRF](#) [1-1825058-6](#)