

TACT SWITCH DTS(M)(J)-6 SERIES

6x6 Surface Mounting Type (Ground Terminal Optional)

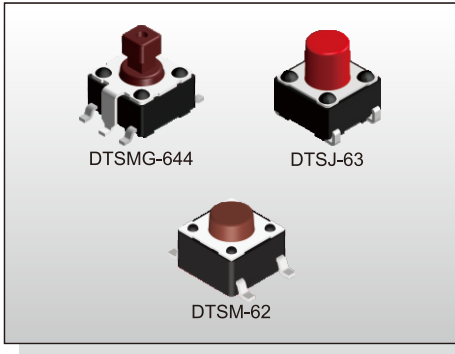

FEATURES

- ※6x6mm, surface mounting type
- ※Optional ground pin
- ※Reflow solderable

APPLICATION

- ※Audio, OA equipment
- ※Instrumentation, Communication
- ※White goods

SPECIFICATION

Contact Rating	50mA, 12V DC
Contact Resistance	100mΩ max.
Insulation Resistance	100MΩ min. 500V DC
Dielectric Strength	250V AC/1 minute
Operating Force	100±50gf, Black(K) 160±50gf, Brown(N) 260±50gf, Red(R) 320±80gf, Salmon(S) 520±130gf, Yellow(Y)
Travel	0.25mm
Operating Life	Phosphor Bronze Dome 50,000 cycles for 520/320gf 100,000 cycles for 260gf 200,000 cycles for 160/100gf Stainless Steel Dome 300,000 cycles for 520/320gf 500,000 cycles for 260gf 1,000,000 cycles for 160/100gf
Operating Temp.	-25°C ~ +70°C
Storage Temp.	-30°C ~ +80°C

HOW TO ORDER

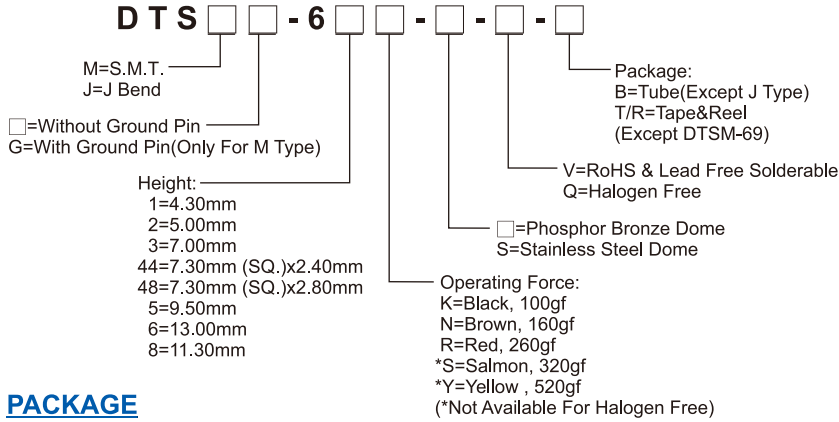

PACKAGE

<Tube>
77 pcs

<Tape & Reel>
DTSM(G)(J)-61 / DTSMG-62:1000 pcs
DTS(M)(J)-62:900 pcs DTS(M)(G)(T)-63, 64:700 pcs DTSJ-65:400 pcs
DTSM(G)-65:380 pcs DTSM-68:300 pcs DTSM-66:200 pcs

CIRCUIT

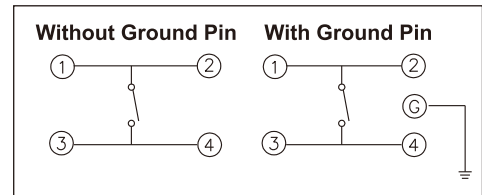

DTSM-6

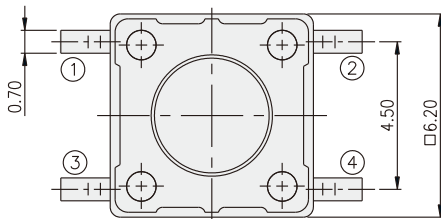

PART NO.	H
DTSM-61	4.30
DTSM-62	5.00
DTSM-63	7.00
DTSM-65	9.50
DTSM-66	13.00
DTSM-68	11.30

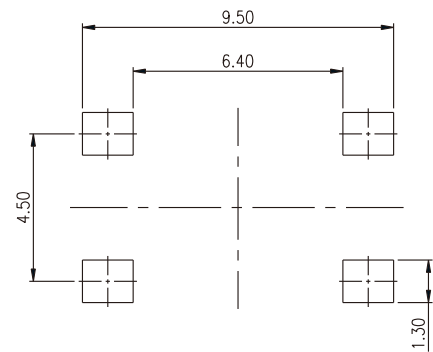
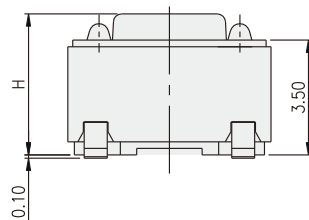
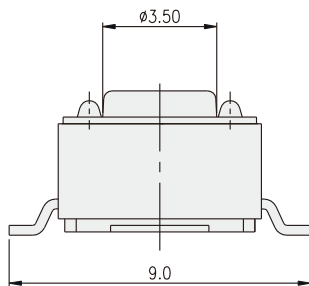

P.C.B. LAYOUT

TACT SWITCH

DTSM-644(8)

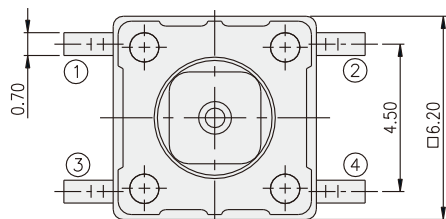

PART NO.	□A	□B
DTSM-644	2.40	1.60
DTSM-648	2.80	2.00

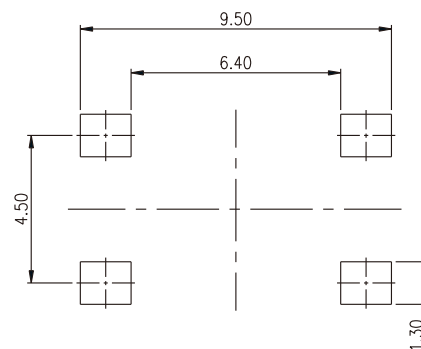
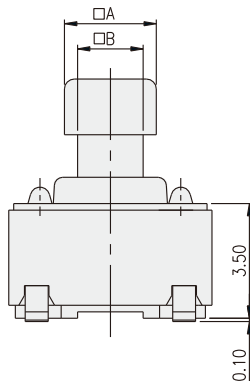
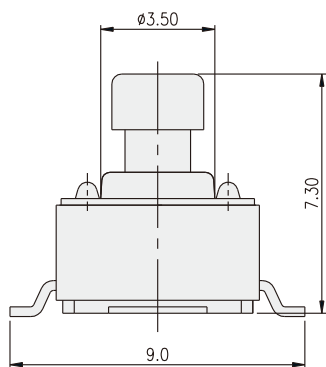

P.C.B. LAYOUT

TACT SWITCH

DTSMG-6

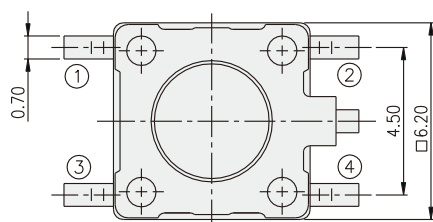

PART NO.	H
DTSMG-61	4.30
DTSMG-62	5.00
DTSMG-63	7.00
DTSMG-65	9.50
DTSMG-66	13.00
DTSMG-68	11.30

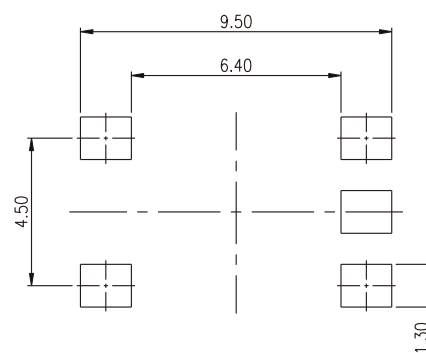
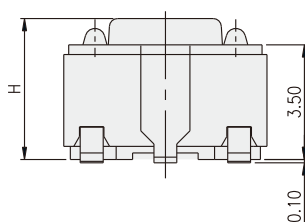
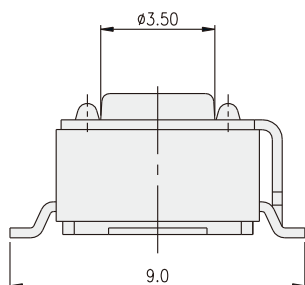

P.C.B. LAYOUT

DTSJ-6

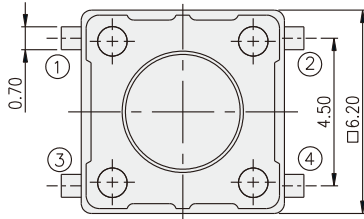

PART NO.	H
DTSJ-61	4.30
DTSJ-62	5.00
DTSJ-63	7.00
DTSJ-65	9.50
DTSJ-66	13.00
DTSJ-68	11.30

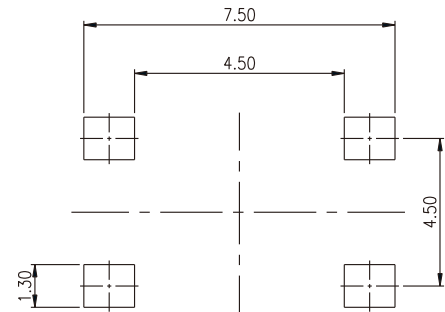
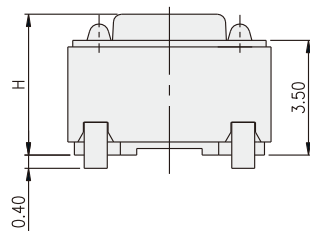
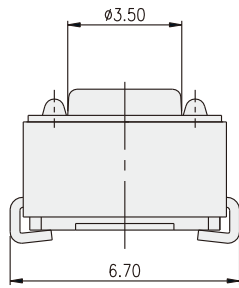

P.C.B. LAYOUT

X-ON Electronics

Largest Supplier of Electrical and Electronic Components

Click to view similar products for [Tactile Switches](#) category:

Click to view products by [Diptronics](#) manufacturer:

Other Similar products are found below :

[KMR633NG LFG](#) [5GTH92001](#) [5GTH9202242](#) [6426-201-11343](#) [MJ1226](#) [MJTP1109B](#) [MJTP1138EAUTR](#) [MJTP1230BL](#) [MJTPSHW](#)
[GS6.90F300QP](#) [1-1977223-0](#) [1-1977120-4](#) [ADTSA62NV](#) [ADTSA62RV](#) [ADTSA63KV](#) [ADTSA644NV](#) [ADTSM24NVTR](#) [ADTSMW66NV](#)
[ADTSMW67RV](#) [ATM533VTR](#) [1571300-3](#) [B3F-3123](#) [B3F-6055A](#) [B3F-B32-01-KIT](#) [1977177-8](#) [1977266-1](#) [2-1977223-4](#) [2-1977223-7](#)
[ADTS644KV](#) [ADTSA61RV](#) [ADTSA62KV](#) [ADTSA63NV](#) [ADTSA63RV](#) [ADTSA65NV](#) [ADTSM21NSVTR](#) [ADTSM25RVTR](#)
[ADTSM31RVTR](#) [ADTSM32NVTR](#) [ADTSM61YVTR](#) [ADTSM63SVTR](#) [ADTSM644KVTR](#) [ADTSMW64RV](#) [ADTSMW69NV](#)
[FSMRA4JHA04](#) [GS4.70F300QP](#) [D38999/20JJ37SA](#) [TL1105B](#) [TL1105J](#) [ATH447K2Q](#) [ATM534VTR](#)