

# TACT SWITCH DTS(M)(J)-6 SERIES

## 6x6 Surface Mounting Type (Ground Terminal Optional)

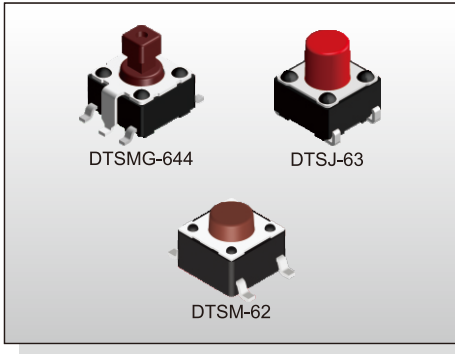

### FEATURES

- ※6x6mm, surface mounting type
- ※Optional ground pin
- ※Reflow solderable

### APPLICATION

- ※Audio, OA equipment
- ※Instrumentation, Communication
- ※White goods

### SPECIFICATION

Contact Rating	50mA, 12V DC
Contact Resistance	100mΩ max.
Insulation Resistance	100MΩ min. 500V DC
Dielectric Strength	250V AC/1 minute
Operating Force	100±50gf, Black(K) 160±50gf, Brown(N) 260±50gf, Red(R) 320±80gf, Salmon(S) 520±130gf, Yellow(Y)
Travel	0.25mm
Operating Life	<b>Phosphor Bronze Dome</b> 50,000 cycles for 520/320gf 100,000 cycles for 260gf 200,000 cycles for 160/100gf <b>Stainless Steel Dome</b> 300,000 cycles for 520/320gf 500,000 cycles for 260gf 1,000,000 cycles for 160/100gf
Operating Temp.	-25°C ~ +70°C
Storage Temp.	-30°C ~ +80°C

### HOW TO ORDER

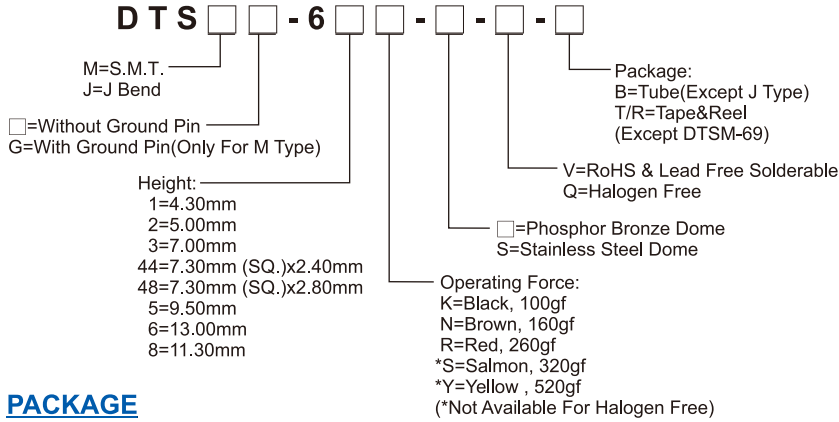

### PACKAGE

<Tube>  
77 pcs

<Tape & Reel>  
DTSM(G)(J)-61 / DTSMG-62:1000 pcs  
DTS(M)(J)-62:900 pcs    DTS(M)(G)(T)-63, 64:700 pcs    DTSJ-65:400 pcs  
DTSM(G)-65:380 pcs    DTSM-68:300 pcs    DTSM-66:200 pcs

### CIRCUIT

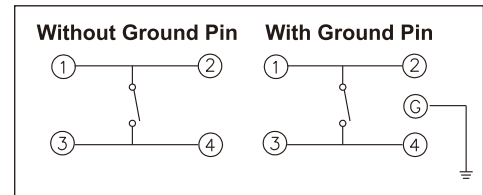

### DTSM-6

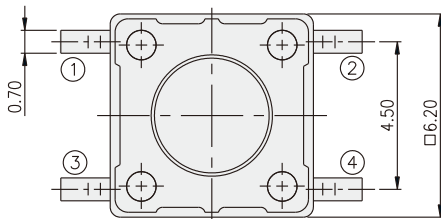

PART NO.	H
DTSM-61	4.30
DTSM-62	5.00
DTSM-63	7.00
DTSM-65	9.50
DTSM-66	13.00
DTSM-68	11.30

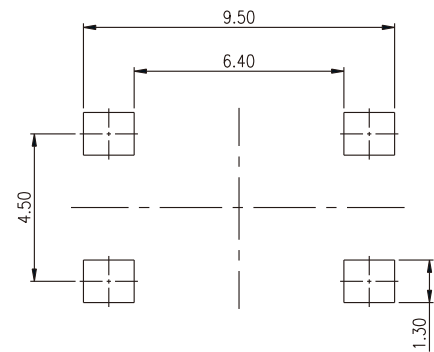
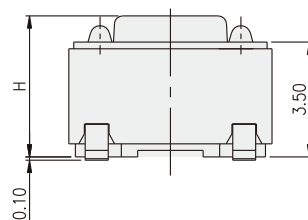
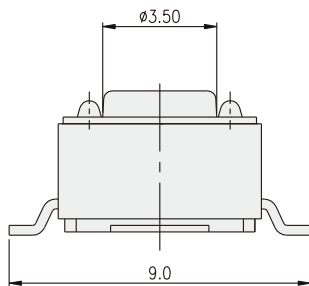

P.C.B. LAYOUT

**DTSM-644(8)**

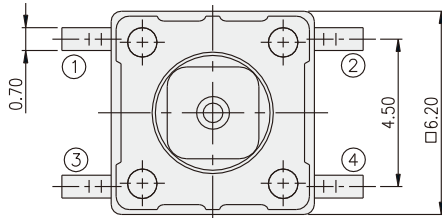

PART NO.	□A	□B
DTSM-644	2.40	1.60
DTSM-648	2.80	2.00

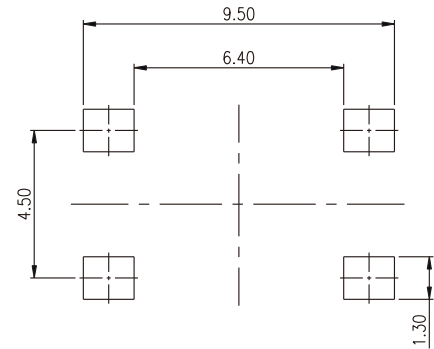
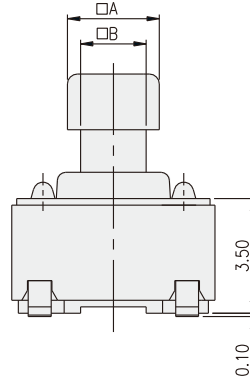
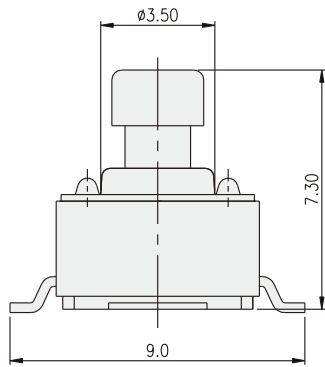

P.C.B. LAYOUT

TACT SWITCH

**DTSMG-6**

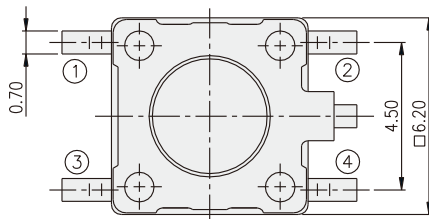

PART NO.	H
DTSMG-61	4.30
DTSMG-62	5.00
DTSMG-63	7.00
DTSMG-65	9.50
DTSMG-66	13.00
DTSMG-68	11.30

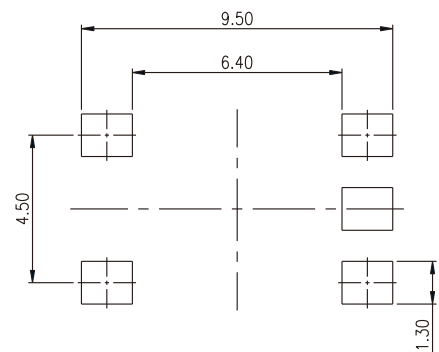
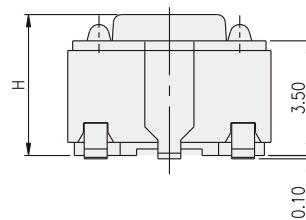
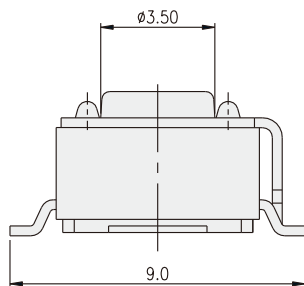

P.C.B. LAYOUT

DTSJ-6

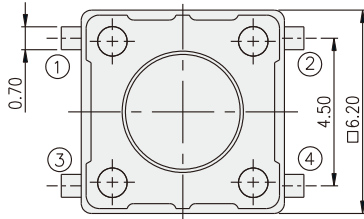

PART NO.	H
DTSJ-61	4.30
DTSJ-62	5.00
DTSJ-63	7.00
DTSJ-65	9.50
DTSJ-66	13.00
DTSJ-68	11.30

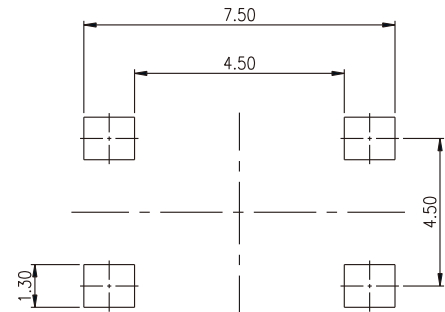
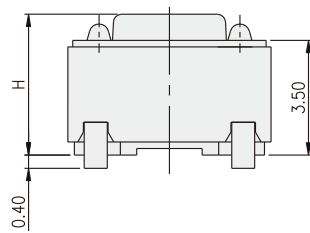
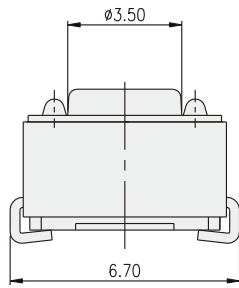

P.C.B. LAYOUT

## X-ON Electronics

Largest Supplier of Electrical and Electronic Components

*Click to view similar products for [Tactile Switches](#) category:*

*Click to view products by [Diptronics](#) manufacturer:*

Other Similar products are found below :

[5GTH92001](#) [5GTH9202242](#) [1-1977120-4](#) [ADTSA62NV](#) [ADTSA62RV](#) [B3F-3123](#) [1977177-8](#) [1977266-1](#) [ADTSA63NV](#) [ADTSM21NSVTR](#)  
[ADTSM25RVTR](#) [ADTSM32NVTR](#) [ADTSMW64RV](#) [FSMRA4JHA04](#) [GS4.70F300QP](#) [3ESH9R](#) [KSC241J SP DELTA LFS](#) [3FTL600RAS](#)  
[3FTL640RAS](#) [Y96K132V0FPLFS](#) [5GSH92001](#) [5GTH9658222](#) [ADTSM31NVTR](#) [2-1977120-7](#) [TSJW-5.2-260-TR](#) [KMT011MNGJLHS](#)  
[ADTSG648NV](#) [ADTSM62KSVTR](#) [ADTSM648NV](#) [95C06E3RAT](#) [3ATH9Q](#) [FSM4JSMLXTR](#) [FSM4JSMXL](#) [FSMRA8JHA04](#) [HARS0073](#)  
[Y97HS12A5RAFP](#) [Y97BT23B2HAFP](#) [Y33R411N9FPLFT](#) [Y31C01402FPLFS](#) [PTS645SK50SMTR92](#) [ADTSM32NVB](#) [KMS233GPWTLFG](#)  
[Y78B42324FP](#) [Y33R21116FPLFT](#) [Y31B43131FPLFG](#) [Y78B64124FP](#) [Y71243251FP](#) [Y33R31119FPLFT](#) [Y97HS12A5TAFP](#)  
[PTS638SK25SMTR2LFS](#)