

TACT SWITCH DTS(M)(J)-6 SERIES

6x6 Surface Mounting Type (Ground Terminal Optional)

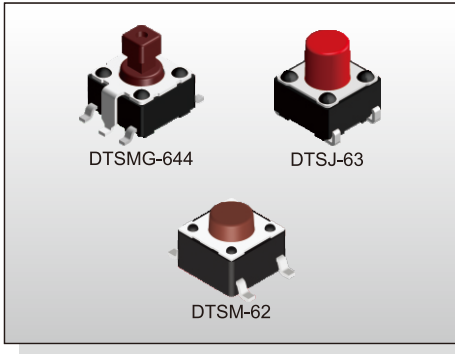

FEATURES

- ※6x6mm, surface mounting type
- ※Optional ground pin
- ※Reflow solderable

APPLICATION

- ※Audio, OA equipment
- ※Instrumentation, Communication
- ※White goods

SPECIFICATION

| | |
|-----------------------|---|
| Contact Rating | 50mA, 12V DC |
| Contact Resistance | 100mΩ max. |
| Insulation Resistance | 100MΩ min. 500V DC |
| Dielectric Strength | 250V AC/1 minute |
| Operating Force | 100±50gf, Black(K) 160±50gf, Brown(N) 260±50gf, Red(R) 320±80gf, Salmon(S) 520±130gf, Yellow(Y) |
| Travel | 0.25mm |
| Operating Life | Phosphor Bronze Dome 50,000 cycles for 520/320gf 100,000 cycles for 260gf 200,000 cycles for 160/100gf Stainless Steel Dome 300,000 cycles for 520/320gf 500,000 cycles for 260gf 1,000,000 cycles for 160/100gf |
| Operating Temp. | -25°C ~ +70°C |
| Storage Temp. | -30°C ~ +80°C |

HOW TO ORDER

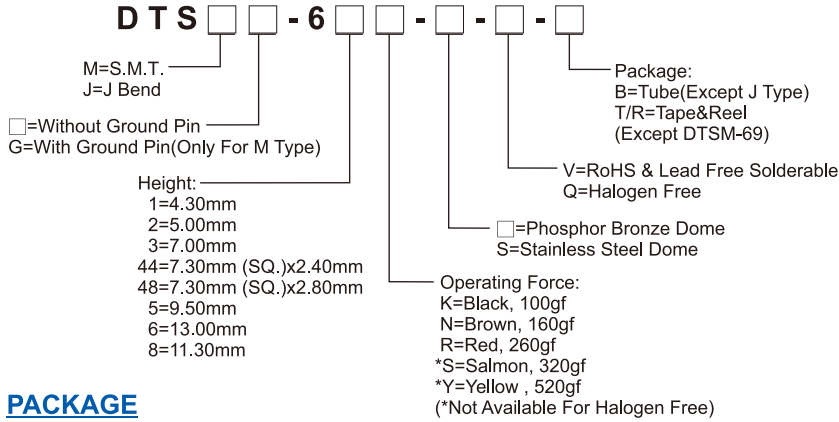

PACKAGE

<Tube>
77 pcs

<Tape & Reel>
DTSM(G)(J)-61 / DTSMG-62:1000 pcs
DTS(M)(J)-62:900 pcs DTS(M)(G)(T)-63, 64:700 pcs DTSJ-65:400 pcs
DTSM(G)-65:380 pcs DTSM-68:300 pcs DTSM-66:200 pcs

CIRCUIT

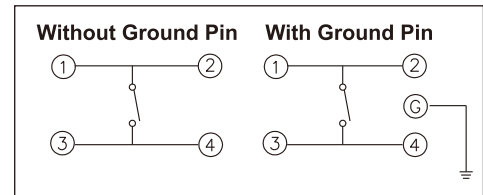

DTSM-6

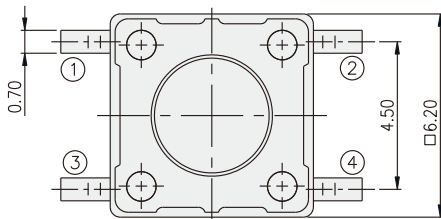

| PART NO. | H |
|----------|-------|
| DTSM-61 | 4.30 |
| DTSM-62 | 5.00 |
| DTSM-63 | 7.00 |
| DTSM-65 | 9.50 |
| DTSM-66 | 13.00 |
| DTSM-68 | 11.30 |

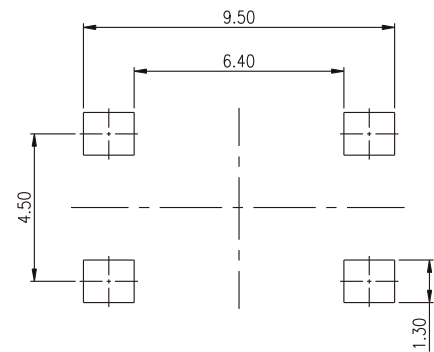
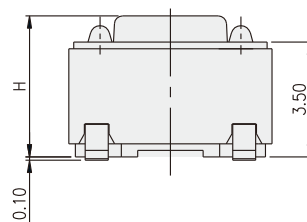
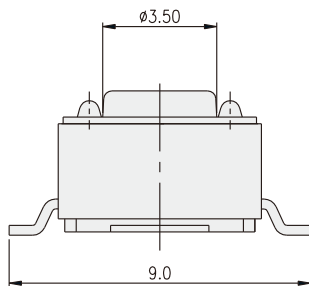

P.C.B. LAYOUT

TACT SWITCH

DTSM-644(8)

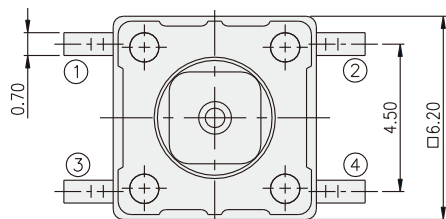

| PART NO. | □A | □B |
|----------|------|------|
| DTSM-644 | 2.40 | 1.60 |
| DTSM-648 | 2.80 | 2.00 |

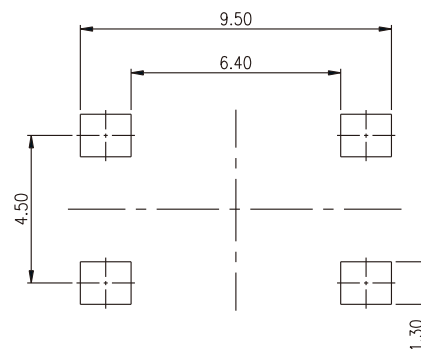
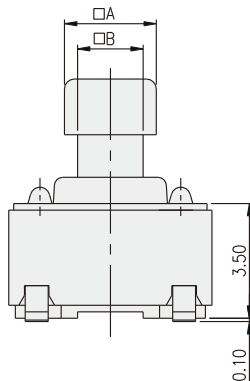
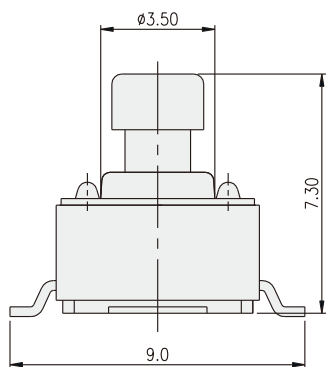

P.C.B. LAYOUT

TACT SWITCH

DTSMG-6

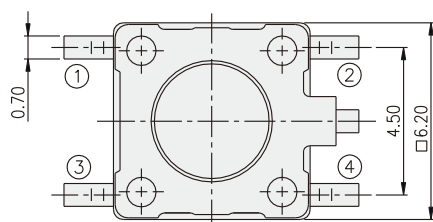

| PART NO. | H |
|----------|-------|
| DTSMG-61 | 4.30 |
| DTSMG-62 | 5.00 |
| DTSMG-63 | 7.00 |
| DTSMG-65 | 9.50 |
| DTSMG-66 | 13.00 |
| DTSMG-68 | 11.30 |

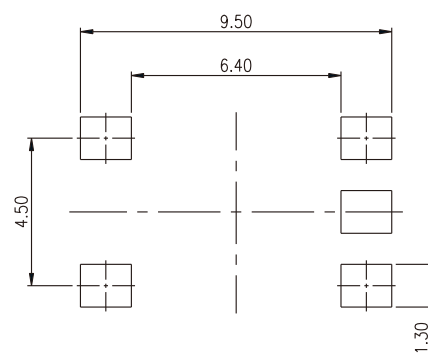
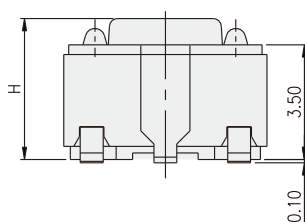
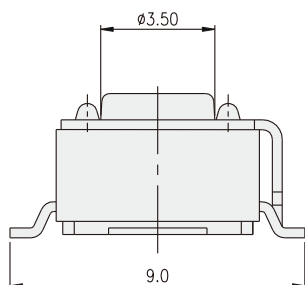

P.C.B. LAYOUT

DTSJ-6

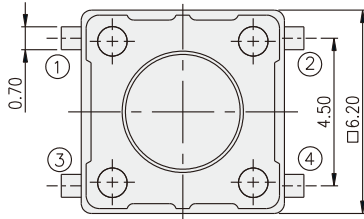

| PART NO. | H |
|----------|-------|
| DTSJ-61 | 4.30 |
| DTSJ-62 | 5.00 |
| DTSJ-63 | 7.00 |
| DTSJ-65 | 9.50 |
| DTSJ-66 | 13.00 |
| DTSJ-68 | 11.30 |

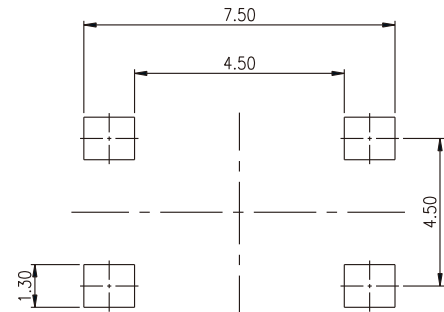
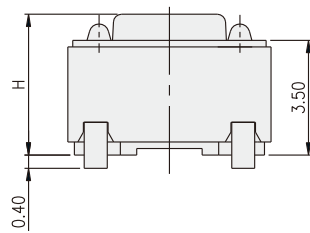
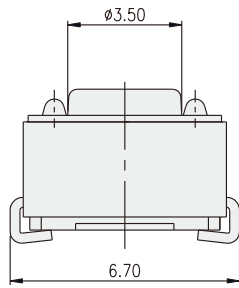

P.C.B. LAYOUT

X-ON Electronics

Largest Supplier of Electrical and Electronic Components

Click to view similar products for [Tactile Switches](#) category:

Click to view products by [Diptronics](#) manufacturer:

Other Similar products are found below :

[KMR633NG LFG](#) [5GTH92001](#) [5GTH9202242](#) [6426-201-11343](#) [MJ1226](#) [MJTP1109B](#) [MJTP1138EAUTR](#) [MJTP1230BL](#) [MJTPSHW](#)
[GS6.90F300QP](#) [1-1977223-0](#) [1-1977120-4](#) [ADTSA62NV](#) [ADTSA62RV](#) [ADTSA63KV](#) [ADTSA644NV](#) [ADTSM24NVTR](#) [ADTSMW66NV](#)
[ADTSMW67RV](#) [ATM533VTR](#) [1571300-3](#) [B3F-3123](#) [B3F-6055A](#) [B3F-B32-01-KIT](#) [1977177-8](#) [1977266-1](#) [2-1977223-4](#) [2-1977223-7](#)
[ADTS644KV](#) [ADTSA61RV](#) [ADTSA62KV](#) [ADTSA63NV](#) [ADTSA63RV](#) [ADTSA65NV](#) [ADTSM21NSVTR](#) [ADTSM25RVTR](#)
[ADTSM31RVTR](#) [ADTSM32NVTR](#) [ADTSM61YVTR](#) [ADTSM63SVTR](#) [ADTSM644KVTR](#) [ADTSMW64RV](#) [ADTSMW69NV](#)
[FSMRA4JHA04](#) [GS4.70F300QP](#) [D38999/20JJ37SA](#) [TL1105B](#) [TL1105J](#) [ATH447K2Q](#) [ATM534VTR](#)