

FEATURES

- ※Side actuation
- ※End stackable
- ※Through hole or SMT

APPLICATION

- ※Industrial control
- ※Automatic machines control
- ※Telecommunication

SPECIFICATION

Contact Rating	25mA, 24V DC
Contact Resistance	100mΩ max.
Insulation Resistance	100MΩ min. 500V DC
Dielectric Strength	500V AC/1 minute
Operating Force	800gf max.
Travel	1mm
Operating Life	2,000 cycles
Operating Temp.	-20°C ~ +85°C
Storage Temp.	-40°C ~ +85°C

HOW TO ORDER

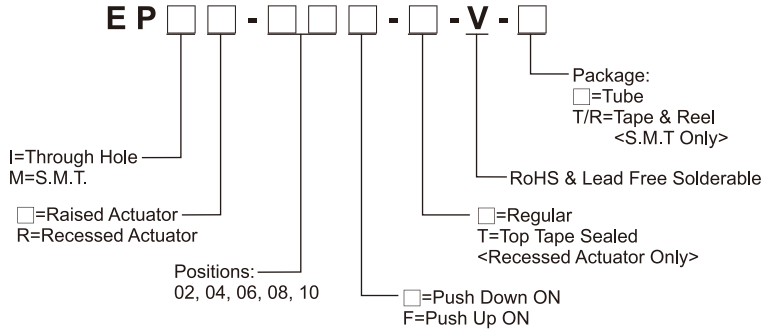

CIRCUIT

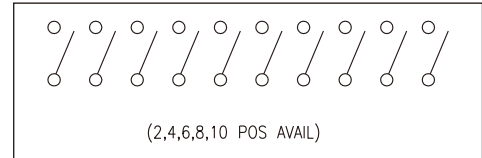

PACKAGE

- <Tube>
- EP□(R)-02: 95 pcs
 - EP□(R)-04: 47 pcs
 - EP□(R)-06: 31 pcs
 - EP□(R)-08: 23 pcs
 - EP□(R)-10: 18 pcs
- <Tape & Reel>
- EPM(R): 700 pcs

EPI(R)

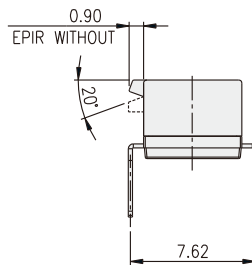
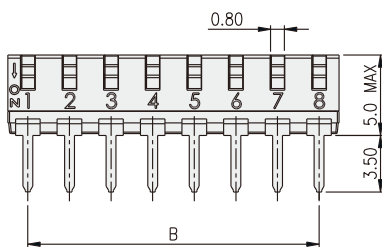
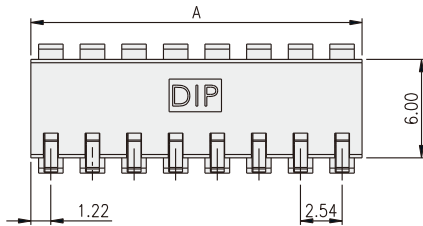

PART NO.	NO.OF POS.	DIM.A	DIM.B
EPI(R)-02	2	4.98	2.54
EPI(R)-04	4	10.06	7.62
EPI(R)-06	6	15.14	12.70
EPI(R)-08	8	20.22	17.78
EPI(R)-10	10	25.30	22.86

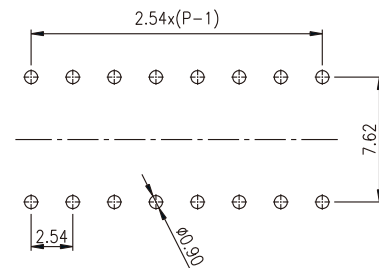

P.C.B. LAYOUT

EPM(R)

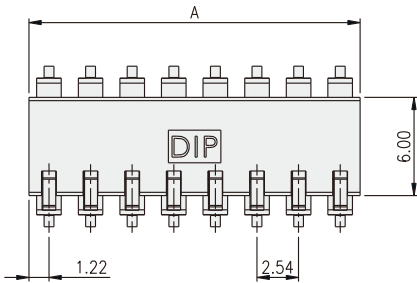

PART NO.	NO.OF POS.	DIM.A	DIM.B
EPM(R)-02	2	4.89	2.54
EPM(R)-04	4	10.06	7.62
EPM(R)-06	6	15.14	12.70
EPM(R)-08	8	20.22	17.78
EPM(R)-10	10	25.30	22.86

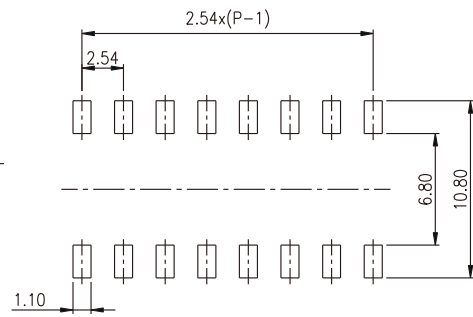
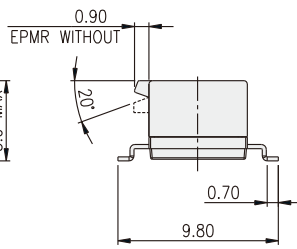
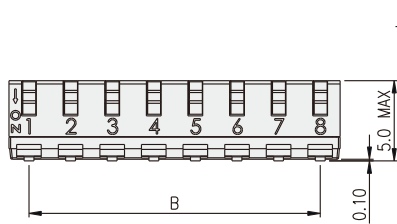

P.C.B. LAYOUT

EPI(R)-F

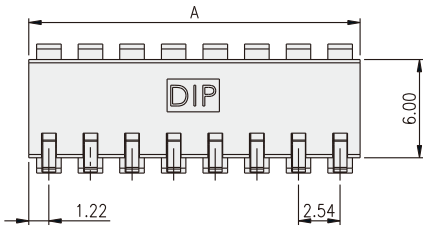

PART NO.	NO.OF POS.	DIM.A	DIM.B
EPI(R)-02F	2	4.89	2.54
EPI(R)-04F	4	10.06	7.62
EPI(R)-06F	6	15.14	12.70
EPI(R)-08F	8	20.22	17.78
EPI(R)-10F	10	25.30	22.86

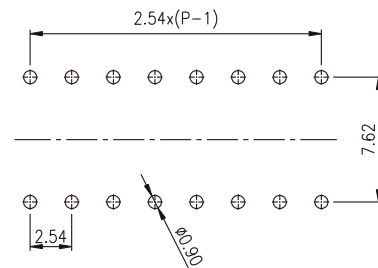
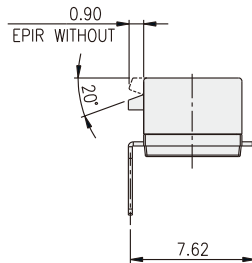
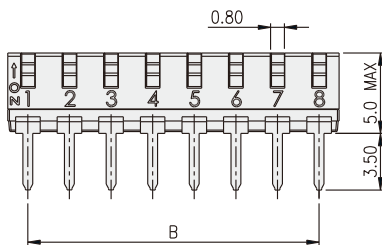

P.C.B. LAYOUT

X-ON Electronics

Largest Supplier of Electrical and Electronic Components

Click to view similar products for [DIP Switches/SIP Switches](#) category:

Click to view products by [Diptronics](#) manufacturer:

Other Similar products are found below :

[78M03S](#) [79B10T](#) [8136-475G4T](#) [G7G-1A2-CB-DC12](#) [A7SS-M](#) [DBP 2110](#) [DBP 2112](#) [DBS1008](#) [DHN02FTVTR](#) [DHN10T](#) [DHS108](#)
[DPL08TN](#) [DRD16CSE04](#) [DRR4010](#) [DRR60016](#) [DRS4016](#) [BD06E](#) [1825008-1](#) [1825444-1](#) [25.350.0653.0](#) [LA2-DC12](#) [SBS 5004 TG](#)
[SDA10H1BDA](#) [97R06ST](#) [A2C-2A5](#) [1825444-7](#) [ADE08SA04](#) [ADE12S04](#) [2161391-1](#) [2-1825058-8](#) [CCVA 2.5/ 4-G-5.08](#) [P26THRR32](#)
[25.330.0653.1](#) [25.352.0353.0](#) [MDG305ST](#) [IKN0600000](#) [IKN0800000](#) [LA2-002-DC24](#) [DBP2008](#) [DBS1003](#) [DBS2008](#) [438872000](#)
[DRD10CRAE04](#) [DRS1604](#) [DSR02T](#) [DSS 208 N](#) [5-1825033-1](#) [106-SDN06-EV](#) [1-1437507-6](#) [E2FMX2D1M1TGJ03M](#)
[E3ZMCT81M1TJ03M](#)