

**FEATURES**

- ※ Compact-sized 2.9x3.9mm
- ※ Vertical or side actuation
- ※ Reflow solderable

**APPLICATION**

- ※ Automotive
- ※ Portable electronic device
- ※ Control panel

**SPECIFICATION**

Contact Rating	50mA, 12V DC
Contact Resistance	100mΩ max.
Insulation Resistance	100MΩ min. 100V DC
Dielectric Strength	100V AC/1 minute
Operating Force	160±50gf (Vertical Push) 220±65gf (Side Push)
Travel	0.13mm (Vertical Push) 0.20mm (Side Push)
Operating Life	100,000 cycles
Operating Temp.	-20°C ~ +70°C
Storage Temp.	-30°C ~ +80°C

**HOW TO ORDER**

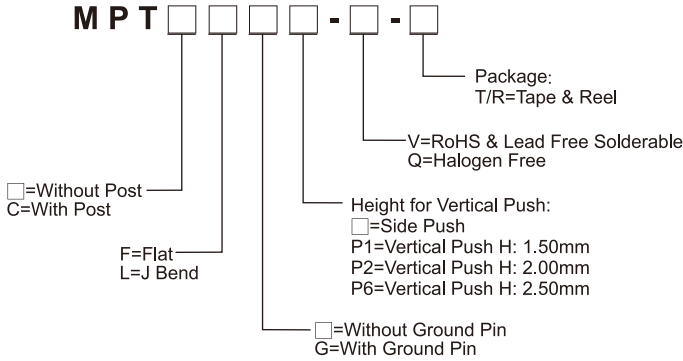

**CIRCUIT**

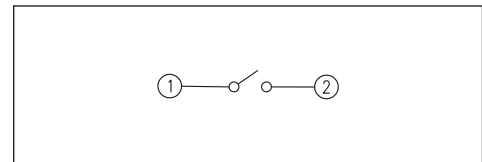

**PACKAGE**

<Tape & Reel>  
Side push: 3500 pcs  
Vertical push: 2000 pcs

TACT SWITCH

**MPTFP** □

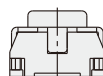
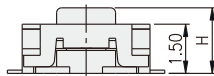
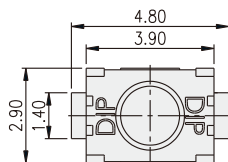

PART NO.	H
MPTFP1	1.50
MPTFP2	2.00
MPTFP6	2.50

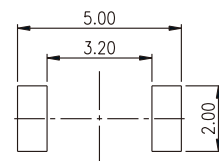

P.C.B. LAYOUT

**MPTCLG**

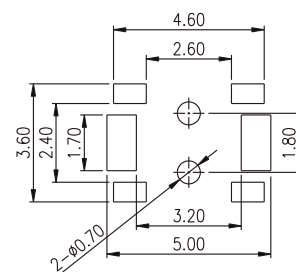
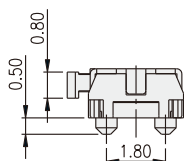
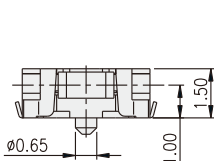
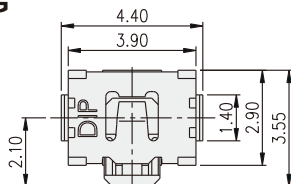

P.C.B. LAYOUT

## X-ON Electronics

Largest Supplier of Electrical and Electronic Components

*Click to view similar products for [Tactile Switches](#) category:*

*Click to view products by [Diptronics](#) manufacturer:*

Other Similar products are found below :

[KMR633NG LFG](#) [5GTH92001](#) [5GTH9202242](#) [6426-201-11343](#) [MJ1226](#) [MJTP1109B](#) [MJTP1138EAUTR](#) [MJTP1230BL](#) [MJTPSHW](#)  
[GS6.90F300QP](#) [1-1977223-0](#) [1-1977120-4](#) [ADTSA62NV](#) [ADTSA62RV](#) [ADTSA63KV](#) [ADTSA644NV](#) [ADTSM24NVTR](#) [ADTSMW66NV](#)  
[ADTSMW67RV](#) [ATM533VTR](#) [1571300-3](#) [B3F-3123](#) [B3F-6055A](#) [B3F-B32-01-KIT](#) [1977177-8](#) [1977266-1](#) [2-1977223-4](#) [2-1977223-7](#)  
[ADTS644KV](#) [ADTSA61RV](#) [ADTSA62KV](#) [ADTSA63NV](#) [ADTSA63RV](#) [ADTSA65NV](#) [ADTSM21NSVTR](#) [ADTSM25RVTR](#)  
[ADTSM31RVTR](#) [ADTSM32NVTR](#) [ADTSM61YVTR](#) [ADTSM63SVTR](#) [ADTSM644KVTR](#) [ADTSMW64RV](#) [ADTSMW69NV](#)  
[FSMRA4JHA04](#) [GS4.70F300QP](#) [D38999/20JJ37SA](#) [TL1105B](#) [TL1105J](#) [ATH447K2Q](#) [ATM534VTR](#)