

FEATURES

- ※Vertical and right angle types
- ※Miniature size with stainless steel cover
- ※Low profile (3.0mm)

APPLICATION

- ※Instrumentation
- ※Industrial automation
- ※Building & Home automation

SPECIFICATION

Contact Rating	25mA, 24V DC
Contact Resistance	100mΩ max.
Insulation Resistance	100MΩ min. 100V DC
Dielectric Strength	250V AC/1 minute
Operating Force	200gf·cm max.
Operating Life	10, 000 Steps
Operating Temp.	-30°C ~ +80°C
Storage Temp.	-40°C ~ +85°C

HOW TO ORDER

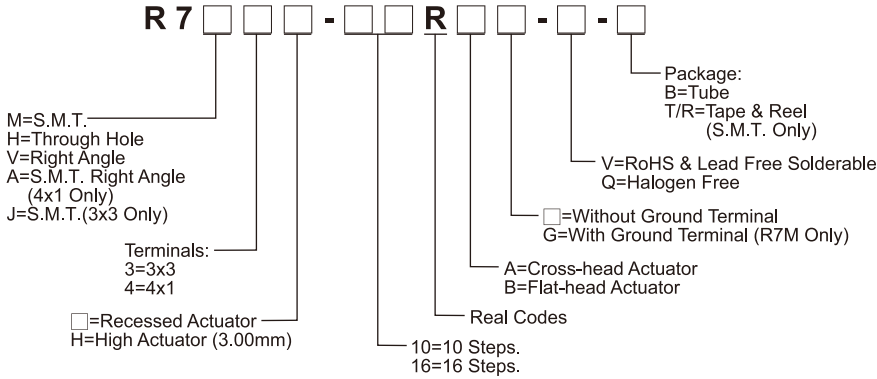

PACKAGE

- <Tube>
R7H, R7M: 63 pcs
R7V: 60 pcs
- <Tape & Reel>
R7M*: 1450 pcs
R7M*H: 850 pcs
R7A: 750 pcs
R7A4H: 750 pcs
R7J: 1450 pcs

ROTARY CODED SWITCH

R7M3-10RAG

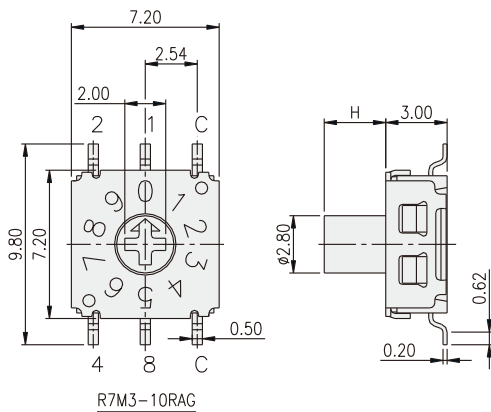

		○ ON ● OFF			
TYPE	POSITION	CODE			
		1	2	4	8
10R	0	●	●	●	●
	1	○	●	●	●
	2	●	○	●	●
	3	○	○	●	●
	4	●	●	○	●
	5	○	○	○	●
	6	●	○	○	●
	7	○	○	○	●
	8	●	●	●	○
	9	○	○	●	○
16R	A	●	○	●	○
	B	○	○	●	○
	C	●	○	○	○
	D	○	●	○	○
	E	●	○	○	○
	F	○	○	○	○

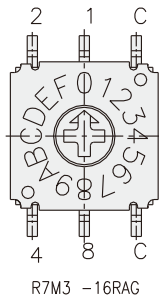

PART NO.	H
R7M3-10RAG	0
R7M3-16RAG	0
R7M3H-10RAG	3.00
R7M3H-16RAG	3.00

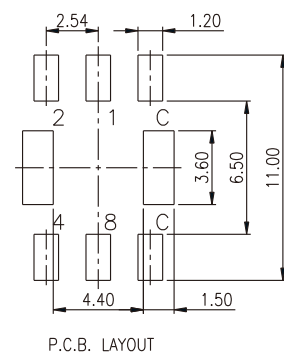

R7H3

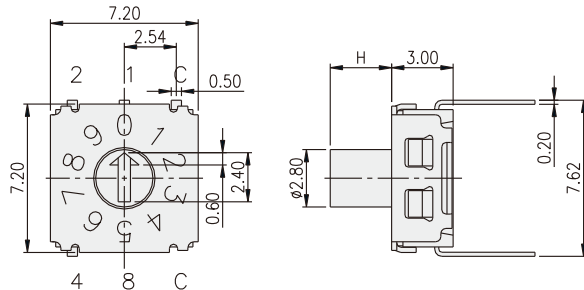

R7H3-10RB

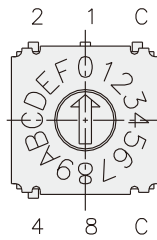

R7H3-16RB

PART NO.	H
R7H3-10RB	0
R7H3-16RB	0
R7H3H-10RB	3.00
R7H3H-16RB	3.00

TYPE	POSITION	CODE			
		1	2	4	8
10R	0	●	●	●	●
	1	○	○	●	●
	2	●	○	●	●
	3	○	○	●	●
	4	●	●	○	●
	5	○	○	○	●
	6	●	○	○	●
	7	○	○	○	●
	8	●	●	●	○
	9	○	○	○	○
16R	A	●	○	●	○
	B	○	○	●	○
	C	●	○	○	○
	D	○	●	○	○
	E	●	○	○	○
	F	○	○	○	○

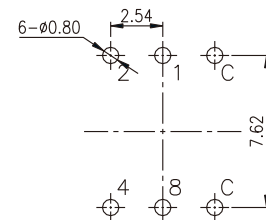

P.C.B. LAYOUT

R7A4

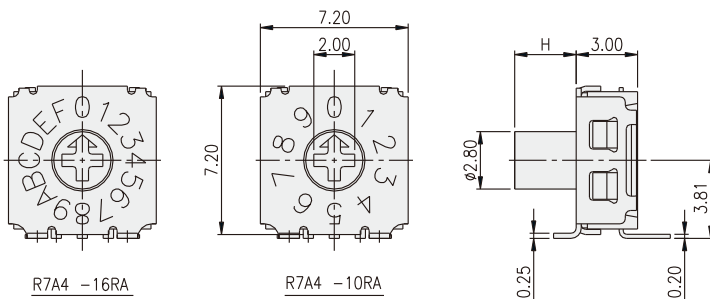

R7A4-16RA

R7A4-10RA

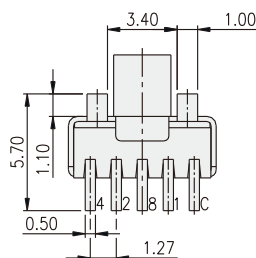

PART NO.	H
R7A4-10RA	0
R7A4-16RA	0
R7A4H-10RA	3.00
R7A4H-16RA	3.00

TYPE	POSITION	CODE			
		1	2	4	8
10R	0	●	●	●	●
	1	○	○	●	●
	2	●	○	●	●
	3	○	○	●	●
	4	●	●	○	●
	5	○	○	○	●
	6	●	○	○	●
	7	○	○	○	●
	8	●	●	●	○
	9	○	○	○	○
16R	A	●	○	●	○
	B	○	○	●	○
	C	●	○	○	○
	D	○	●	○	○
	E	●	○	○	○
	F	○	○	○	○

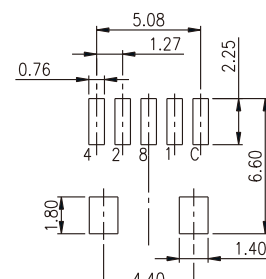

P.C.B. LAYOUT

R7V3

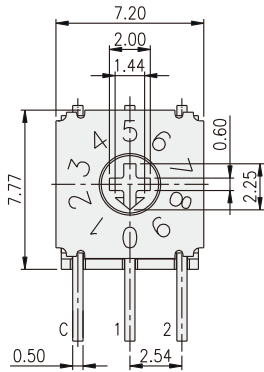

R7V3 -10RA

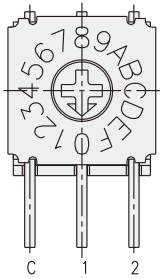
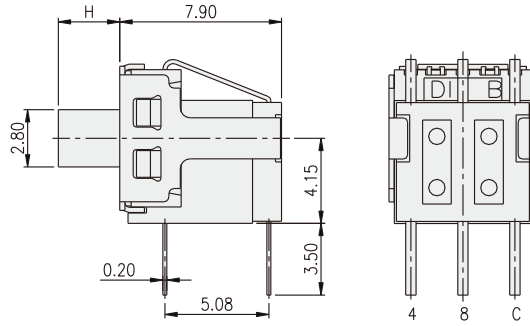

R7V3 -16RA

PART NO.	H
R7V3-10RA	0
R7V3-16RA	0
R7V3H-10RA	3.00
R7V3H-16RA	3.00

TYPE	POSITION	CODE			
		1	2	4	8
10R	0	●	●	●	●
	1	○	○	●	●
	2	●	○	●	●
	3	○	○	●	●
	4	●	○	○	●
	5	○	●	○	●
	6	●	○	○	●
	7	○	○	○	●
	8	●	○	○	○
	9	○	●	○	○
16R	A	●	○	●	○
	B	○	○	●	○
	C	●	●	○	○
	D	○	●	○	○
	E	●	○	○	○
	F	○	○	○	○

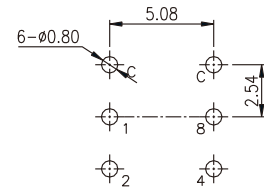

P.C.B. LAYOUT

R7J3

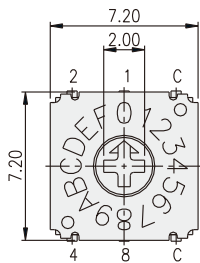

R7J3-16RA

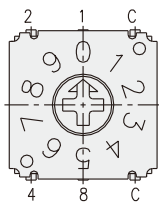
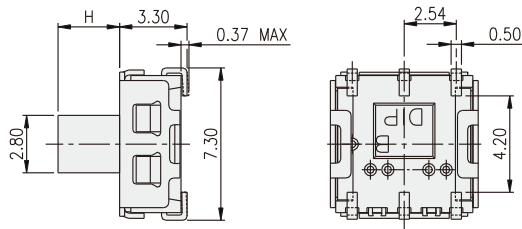

R7J3-10RA

PART NO.	H
R7J3-10RA	0
R7J3-16RA	0
R7J3H-10RA	3.00
R7J3H-16RA	3.00

TYPE	POSITION	CODE			
		1	2	4	8
10R	0	●	●	●	●
	1	○	○	●	●
	2	●	○	●	●
	3	○	○	●	●
	4	●	○	○	●
	5	○	●	○	●
	6	●	○	○	●
	7	○	○	○	●
	8	●	○	○	○
	9	○	●	○	○
16R	A	●	○	●	○
	B	○	○	●	○
	C	●	●	○	○
	D	○	○	○	○
	E	●	○	○	○
	F	○	○	○	○

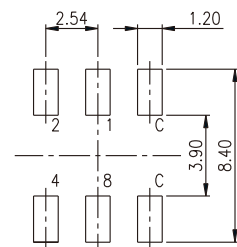

P.C.B. LAYOUT

X-ON Electronics

Largest Supplier of Electrical and Electronic Components

Click to view similar products for [Coded Rotary Switches](#) category:

Click to view products by [Diptronics](#) manufacturer:

Other Similar products are found below :

[PT65SG178](#) [PT65SG23](#) [DRS4010](#) [CW1S-2E11](#) [S-1031A](#) [SBS1004](#) [P36S101TR](#) [P65THR101L254](#) [RM3AF-10R-V-T/R](#) [RH3HAF-10R-V-B](#)
[PT65501RT](#) [P25SMT101TR](#) [P65SMT101](#) [P65THR101V](#) [MSDR-10H1](#) [GSDR-10S](#) [01-1433](#) [07-3153](#) [07-3154](#) [CRD10CM0SBR](#) [DRS4116](#)
[94HCB16RAT](#) [94HCB10T](#) [94HBB16WT](#) [94HBB16RAT](#) [94HBB10WT](#) [94HBB10RAT](#) [94HBB08RAT](#) [94HAC10T](#) [94HAB16WT](#)
[94HAB16T](#) [94HAB10WT](#) [94HAB10RAT](#) [94HAB08WT](#) [94HAB08RAT](#) [ND3FR10P](#) [ND3FR16B-R](#) [DRR3110](#) [94HEB08WRT](#)
[94HCB16WT](#) [94HCB16T](#) [94HCB10RAT](#) [94HCB08T](#) [94HBB16T](#) [94HBB10T](#) [94HBB08T](#) [94HAB16RAT](#) [94HAB10T](#) [94HAB08T](#) [S-2011A](#)