

Display Elektronik GmbH

DATA SHEET

TFT- MODULE

DEM 1024600L VMH-PW-N

7" TFT

Product Specification

Ver.: 1

26.09.2018

Revise Records

Rev.	Date	Contents	Written	Approved
0	27.08.2018	Preliminary Specification	R	LF
1	26.09.2018	Change the Electrical Absolute Maximum Ratings	R	MHI

Special Notes

Note1.	
Note2.	
Note3.	
Note4.	
Note5.	

Contents

1. General Description and Features	4
1.1 Features	4
1.2 LCD Module	4
2. Mechanical Information	4
3. Electrical Specifications.....	5
3.1 Absolute Max. Ratings	5
3.2 Timing Characteristic of The LCD.....	7
3.3 Power On/Off Sequence	11
3.4 Back-Light Unit	12
4. Optical Characteristics	13
4.1 Optical characteristic of the LCD	13
5. I/O Terminal.....	15
5.1 Pin Assignment	15
5.2 Block Diagram.....	16
6. Displayed Color and Input Data	17
7. Reliability Condition	18
8. Dimensional Outlines.....	19
9. Incoming Inspection Standards	20

1. General Description and Features

DME 1024600L VMH-PW-N is 7.0" color TFT (Thin Film Transistor) liquid crystal display composed of a TFT-LCD module, a driver circuit and a back-light unit. By applying 1024×600 images are displayed on the 7.0" diagonal screen. Display 16.7M colors by R.G.B signal input.

1.1 Features

- Back-light with 27 LEDs are available.
- IPS
- 7.0(16:9 diagonal) inch configuration
- ROHS Compliance

1.2 LCD Module

Item	Specification	Unit
Screen Size	7.0 Inches	Diagonal
Display Resolution	1024 x 600	Pixel
Active Area	154.21 x 85.92	mm
Outline Dimension	170.00 x 110.00 x 6.85	mm
Display Mode	Normally Black	--
Color Arrangement	RGB-Vertical Stripe	--
Pixel pitch	0.1506 x 0.1432	mm
Viewing Direction	All	--
Input Interface	LVDS	--

2. Mechanical Information

Item		Min.	Typ.	Max.	Unit	Note
Module Size	Horizontal	169.70	170.00	170.30	mm	
	Vertical	101.70	110.00	110.30	mm	
	Thickness	6.55	6.85	7.15	mm	(1)
Weight		--	(TBD)	--	g	--

Note (1) Not Include Component. Refer to the Outline Dimension Drawing as attached.

3. Electrical Specifications

3.1 Absolute Max. Ratings

3.1.1 Absolute Ratings of Environment

If the operating condition exceeds the following absolute maximum ratings, the TFT LCD module may be damaged permanently.

(Ta=25±2°C, Vss=GND=0)

Item	Symbol	Min.	Max.	Unit	Note
Storage Temperature	T _{STG}	-30	80	°C	(1)
Operating Temperature	T _{OPR}	-20	70	°C	(1,2,3)

Note (1) 90 % RH Max. (40 °C ≥ Ta). Maximum wet-bulb temperature at 39 °C or less. (Ta > 40 °C) No condensation.

Note (2) In case of below 0°, the response time of liquid crystal (LC) becomes slower and the color of panel becomes darker than normal one. Level of retardation depends on temperature, because of LC's character

Note (3) Only operation is guaranteed at operating temperature. Contrast, response time, another display quality are evaluated at +25°C.

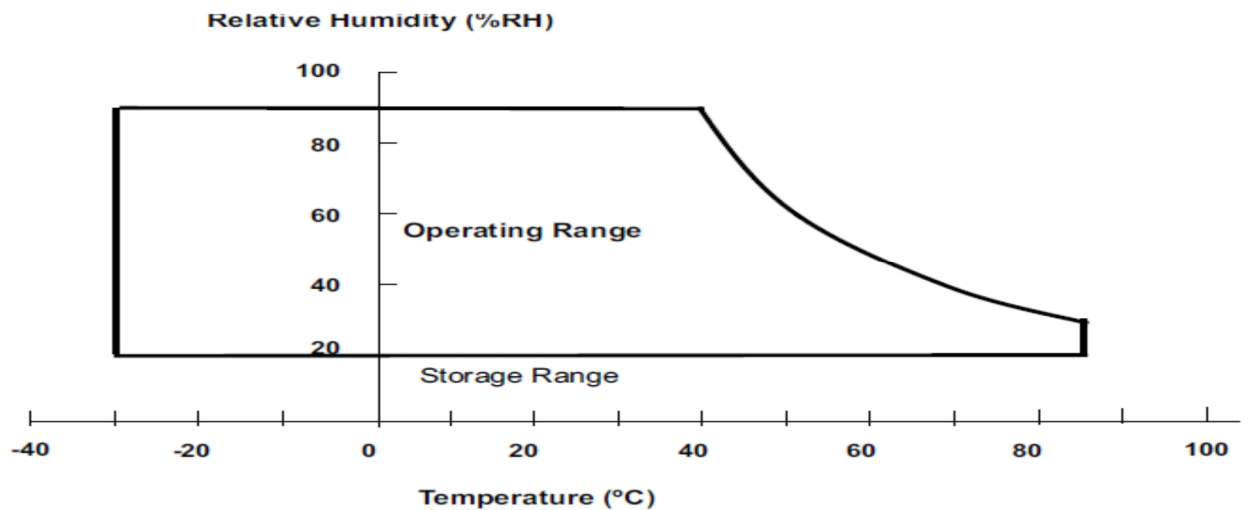

3.1.2 Electrical Absolute Maximum Ratings

3.1.2.1 TFT-LCD Module

(Vss=GND=0)

Parameter	Symbol	Min.	Max.	Unit	Remark
Power Supply Voltage	V _{CC 3.3V}	2.3	3.6	V	

3.1.2.2 Backlight Unit

(Vss=GND=0)

Parameter	Symbol	Min.	Max.	Unit	Remark
Current of Backlight Unit	IB	--	980	mA	
Voltage of Backlight Unit	VB	--	10.2	V	

3.1.3 DC Electrical Characteristics of the TFT LCD

LVDS mode (Receiver Differential Input (PIND0~PIND3, NIND0~NIND3, PINC, NINC))

Parameter	Symbol	Min	Typ.	Max.	Unit	Conditions
Differential input high threshold voltage	R_{xVTH}			0.1	V	$R_{xVCM} = 1.2V$
Differential input low threshold voltage	R_{xVTL}	-0.1			V	
Input voltage range (singled-end)	R_{xVIN}	0		2.4	V	
Differential input common mode voltage	R_{xVCM}	$ V_{ID} / 2$		$2.4 - V_{ID} / 2$	V	
Differential input voltage	$ V_{ID} $	0.2		0.6	V	
Differential input leakage current	$R_{V_{xIz}}$	-10		10	μA	
Power supply Operating current	ICC		(230)	(320)	mA	

(Include 3.3V DC-VGH, VGL, AVDD, VCOM Driver current).

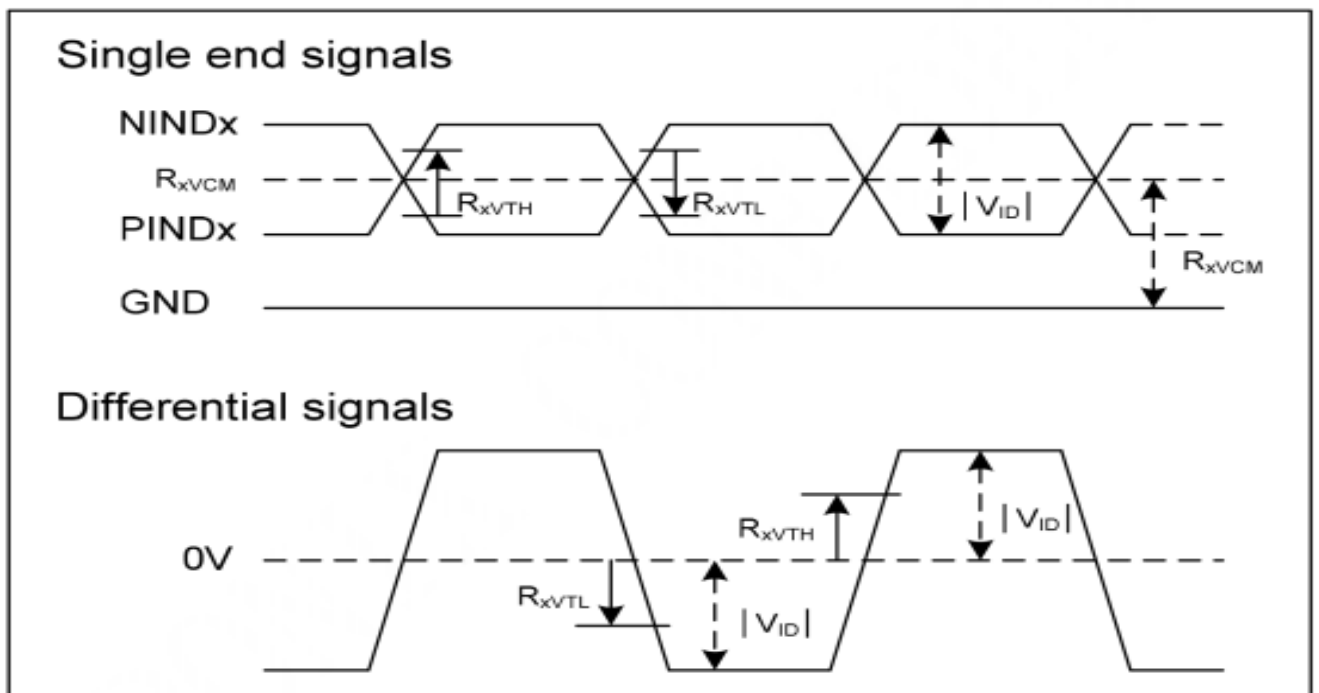

3.2 Timing Characteristic of The LCD

3.2.1 Timing Condition Timing Characteristic

LVDS mode

Parameter	Symbol	Min	Typ.	Max.	Unit	Conditions
Clock Frequency	R_{xFCLK}	20		71	MHz	
Input data skew margin	T_{RSKM}	500			ps	$ V_{ID} = 400mV$ $R_{xVCM} = 1.2V$ $R_{xFCLK} = 71MHz$
Clock high time	T_{LVCH}		$4/(7 \times R_{xFCLK})$		ns	
Clock low time	T_{LVCL}		$3/(7 \times R_{xFCLK})$		ns	
PLL wake-up time	T_{enPLL}			150	us	

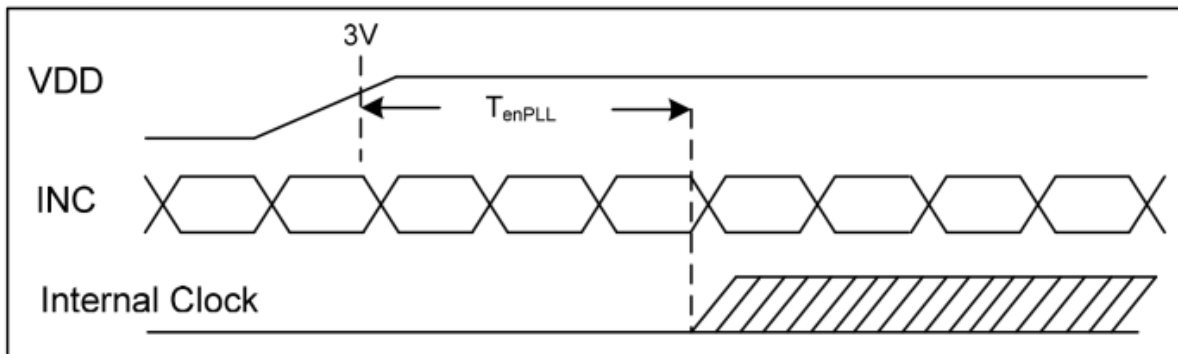
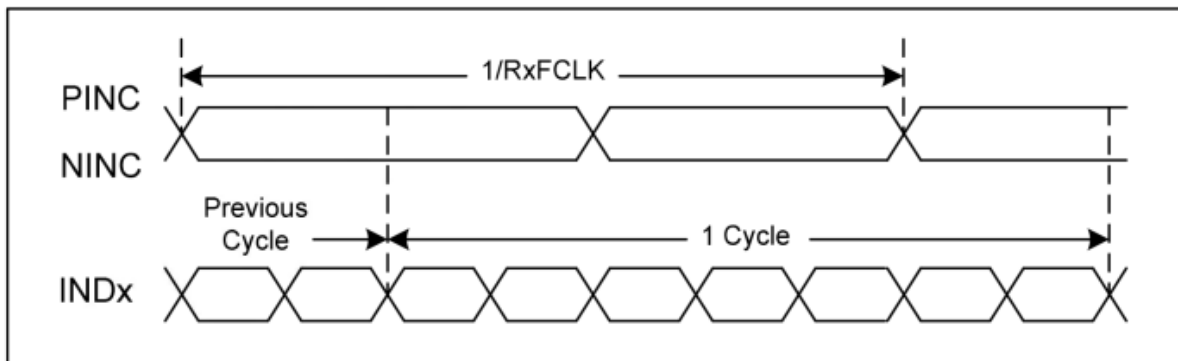

3.2.2 Data Input ForData Input Format For LVDS

6 bit LVDS input(HSD="H")

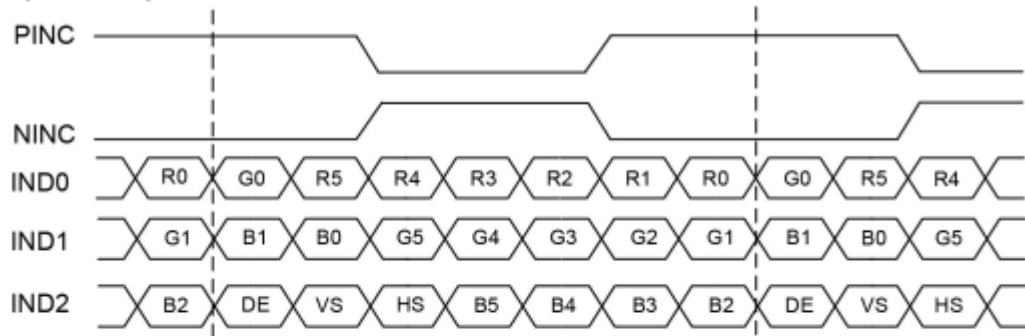

8 bit LVDS input(HSD="L")

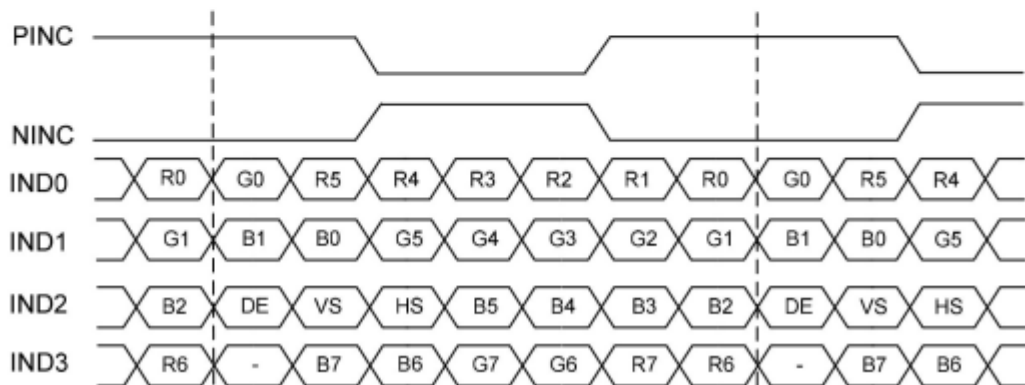

Timing Table

Parameter	Symbol	Min	Typ.	Max.	Unit	Conditions
CLKIN Frequency	Fclk	-	65	71	MHz	VDD=2.3V~3.6V
CLKIN Cycle Time	Tclk	14.1	15.4	-	ns	
CLKIN Pulse Duty	Tcwh	40	50	60	%	Tclk
Time from HSD to Source Output	Thso	-	64	-	CLKIN	
Time from HSD to LD	Thld	-	64	-	CLKIN	
Time from HSD to STV	Thstv	-	2	-	CLKIN	
Time from HSD to CKV	Thckv	-	20	-	CLKIN	
Time from HSD to OEV	Thoev	-	4	-	CLKIN	
LD pulse width	Twld	-	10	-	CLKIN	
CKV pulse width	Twckv	-	66	-	CLKIN	
OEV pulse width	Twoev	-	74	-	CLKIN	

Timing Diagram

Input Clock and Data Timing Diagram

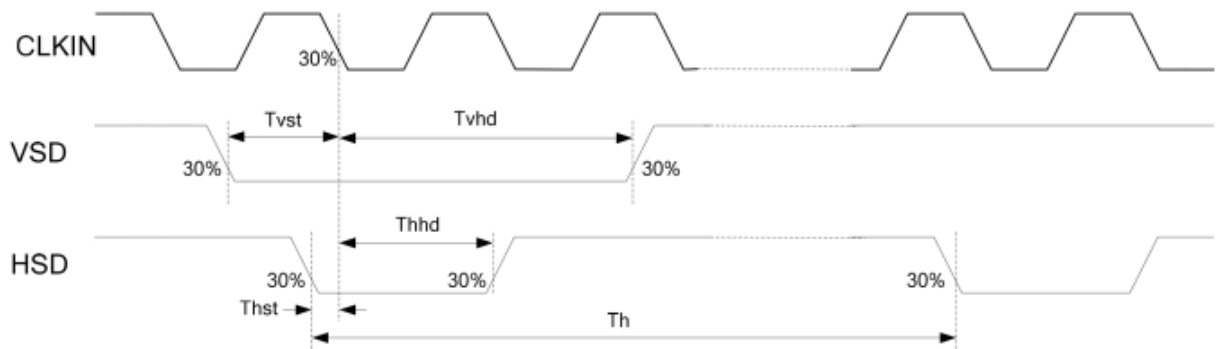
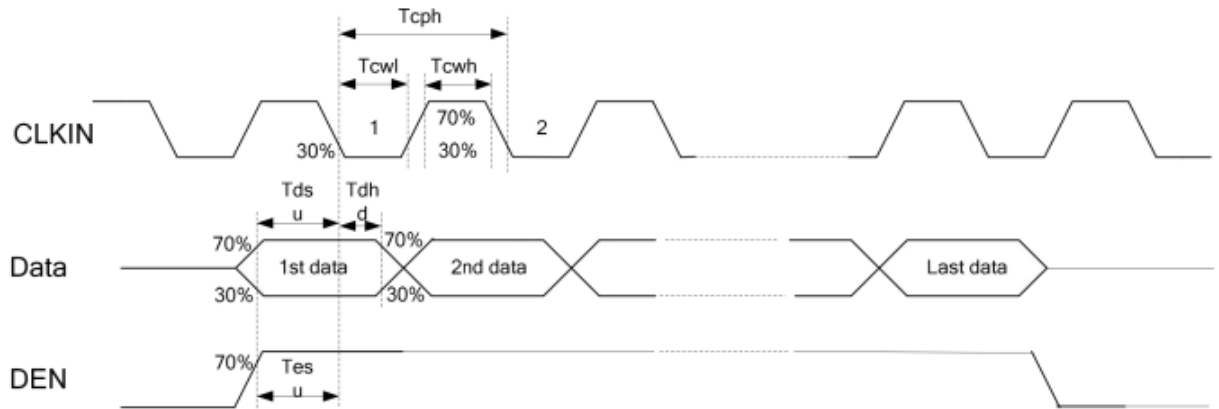

Gate output Timing Diagram (Dual Gate)

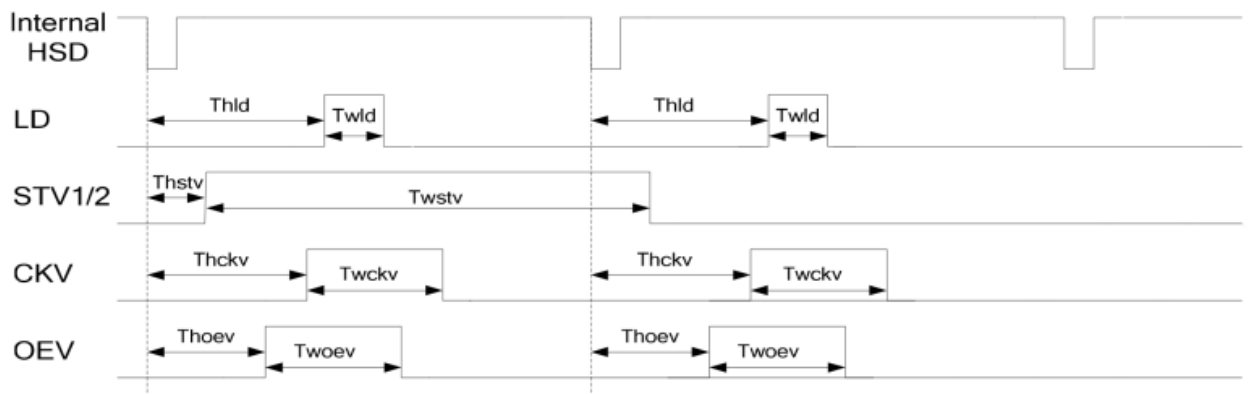

For 1024x600 panel**MODE="H" : DE mode**

Parameter	Symbol	Value			Unit
		Min.	Typ.	Max.	
CLKIN frequency@ Frame rate = 60Hz	fclk	40.8	51.2	67.2	MHz
Horizontal display area	thd	1024			CLKIN
1 Horizontal Line	th	1114	1344	1400	
HSD Blanking	thb+thfp	90	320	376	
Vertical display area	tvd	600			H
1 vertical Line	tv	610	635	800	
VSD Blanking	tvb+tvfp	10	35	200	

MODE="L" : SYNC mode

Horizontal input timing

Parameter	Symbol	Value			Unit
		Min.	Typ.	Max.	
CLKIN frequency@ Frame rate = 60Hz	fclk	44.9	51.2	63	MHz
Horizontal display area	thd	1024			CLKIN
1 Horizontal Line	th	1200	1344	1400	
HSD pulse width	thpw	1	-	140	
HSD Blanking	thb	160			
HSD Front Porch	thfp	16	160	216	

Vertical input timing

Parameter	Symbol	Value			Unit
		Min.	Typ.	Max.	
Vertical display area	tvd	600			H
VSD period time	tv	624	635	750	
VSD pulse width	tpw	1	-	20	
VSD Blanking	tvb	23			
VSD Front Porch	tvfp	1	12	127	

3.3 Power On/Off Sequence

In order to prevent IC from power on reset fail, the rising time (TPOR) of the digital power supply VDD should be maintained within the given specifications. Refer to "AC Characteristics" for more detail on timing.

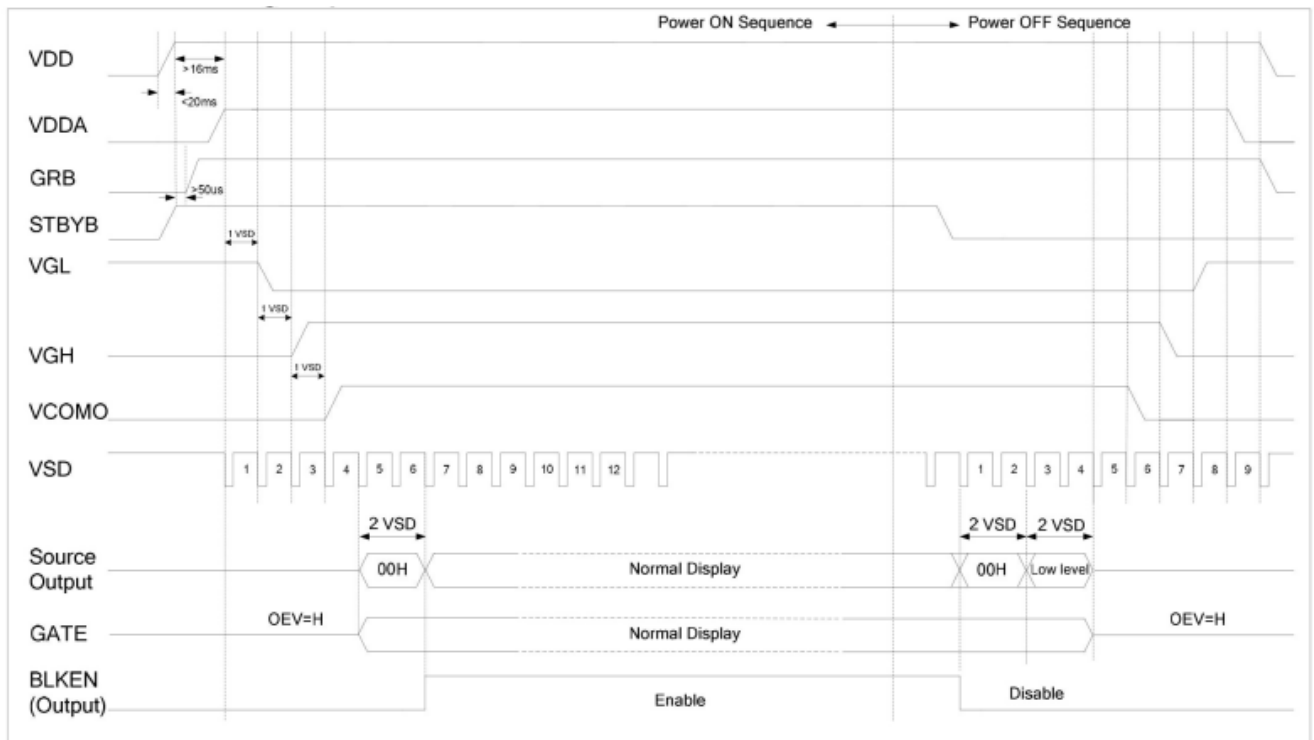

Standby Mode Sequence

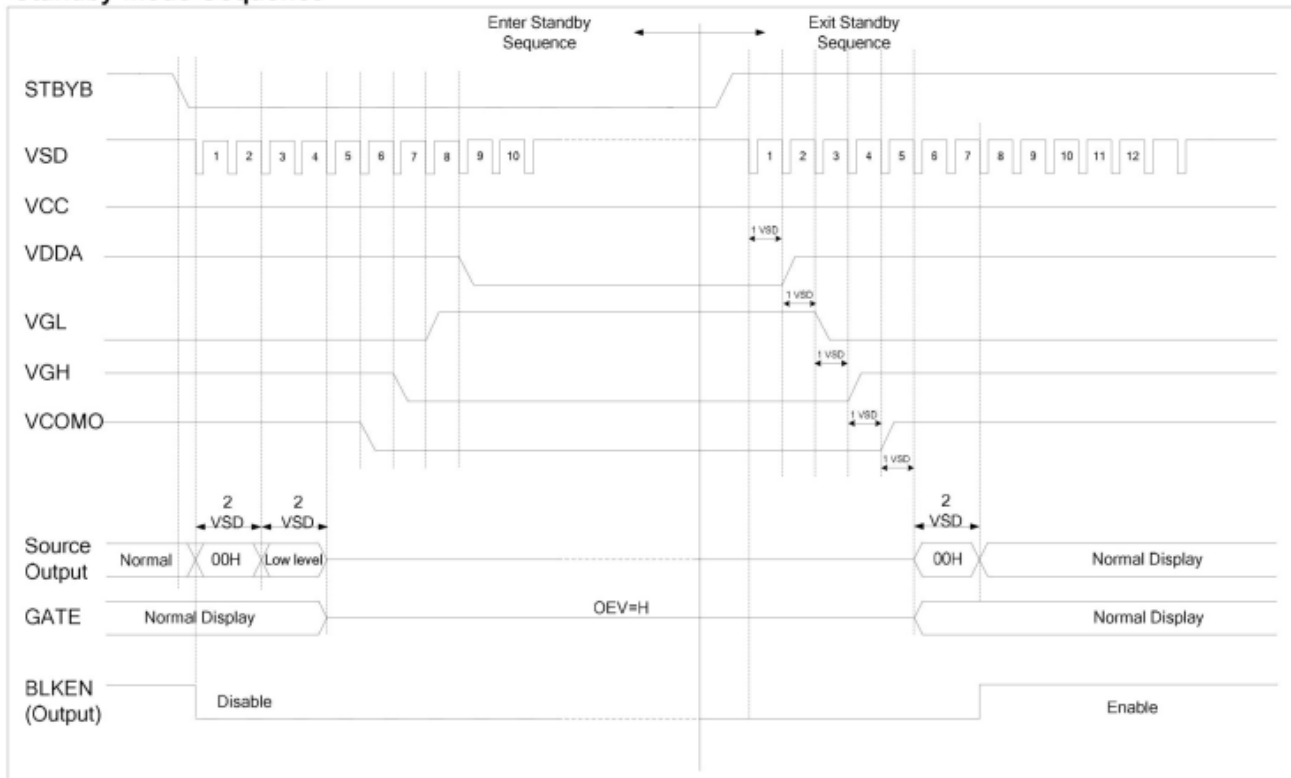

Note : Low level=3FH , when NBW=L(Normally white)
 Low level=00H , when NBW=H(Normally black)

3.4 Back-Light Unit

The Back-light system is an edge-lighting type with 27white LEDs (Light Emitting Diode). The characteristics of 27 white LEDs are shown in the following tables.

(Ta= Room Temp)

Characteristics	Symbol	Min.	Typ.	Max.	Unit	Note
Forward Voltage	VB	7.8	9.6	10.2	V	
Forward Current	IB	-	720	-	mA	(1)
Power Consumption	P _{BL}	-	6912	-	mW	(2)
LED Lifetime	-	35000	50000	-	hr	(3)

Note (1) LEDs in 3 series x 9 parallel type.

(2) Where IB = 720mA, VB = 9.6, P_{BL} = VB × IB

(3) The environmental conducted under ambient air flow ,at Ta=25±2°C, 60%RH±5%

CIRCUIT DIAGRAM (LED 3*9=27)

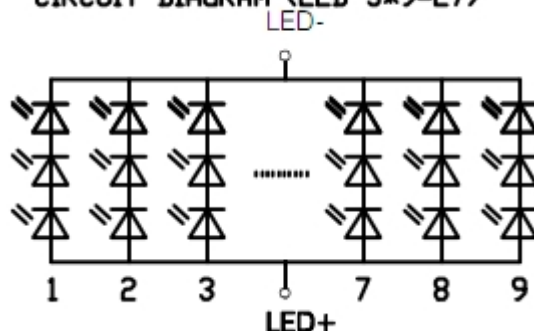

4. Optical Characteristics

4.1 Optical characteristic of the LCD

The following items are measured under stable conditions. The optical characteristics should be measured in a dark room or equivalent state with the methods.

Measuring equipment: BM-7A

Item	Symbol	Condition	Min	Type	Max	Unit	Note	
Brightness	B		800	1000	--	cd/m ²		
Response Time	T _r	θ=0°	-	13	20	ms	.	
	T _f		--	15	25	ms		
Contrast Ratio	CR	At optimized viewing angle	600	800	--	--		
Luminance Uniformity	ΔL		70	75		%		
Color Chromaticity (CIE 1931)	White	W _x	θ=0° Normal Viewing Angle	0.260	0.310	0.360	--	BM-7A
		W _y		0.290	0.340	0.390		
Viewing Angle	Hor.	θ _R	CR≥10	80	85	--	Degree	
		θ _L		80	85	--		
	Ver.	θ _U		80	85	--		
		θ _D		80	85	--		

a. Test equipment setup

After stabilizing and leaving the panel alone shall be warmed up for the stable operation of LCM, the measurement should be executed. Measurement should be executed in a stable, windless, and dark room. Optical specifications are measured by Topcon BM-7(fast) with a viewing angle of 2° at a distance of 50cm and normal direction.

b. Definition of response time: Tr and Tf

The response time is defined as the following figure and shall be measured by switching the input signal for "black" and "white".

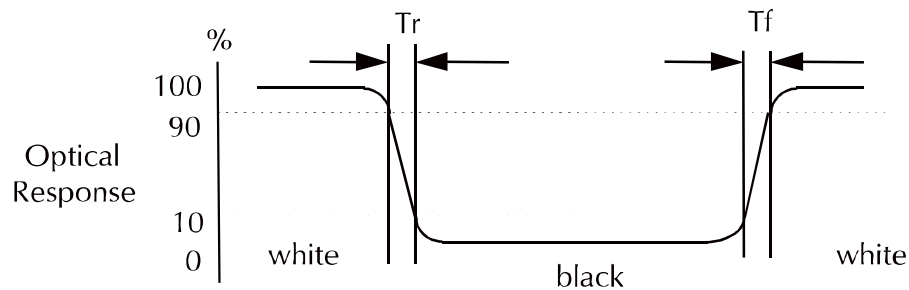

c. Definition of contrast ratio:

$$\text{Contrast Ratio (CR)} = \frac{\text{Brightness measured when LCD is at "white state"}}{\text{Brightness measured when LCD is at "black state"}}$$

- d. Measured at the center area of the panel when all the input terminals of LCD panel are electrically opened.
- e. View Angle

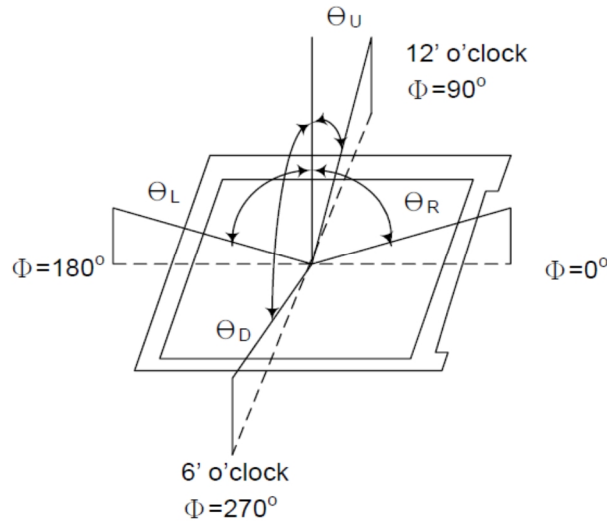

- f. Definition of Luminance of White: Luminance of white at the center points

Light Source of Back-Light Unit	LED Type
---------------------------------	----------

- g. Definition of White Uniformity

$$\text{White Uniformity} = \frac{\text{Min. luminance of white among 9-points}}{\text{Max. luminance of white among 9-points}} \times 100\%$$

- h. The definition of Color Gamut -Color Chromaticity CIE 1931

Color coordinate of white & red, green, blue at center point.

Color Gamut : NTSC(%) = (RGB Triangle Area / NTSC Triangle Area) x 100

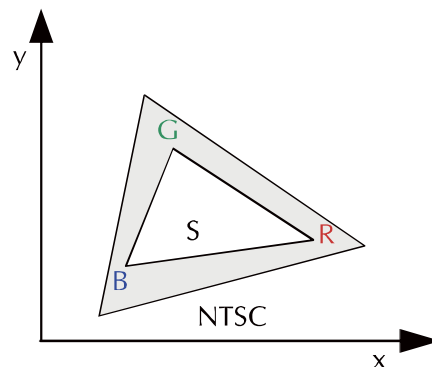

5. I/O Terminal

5.1 Pin Assignment

Pin No.	Symbol	I/O	Function	Remark
1	VCC/VDD	P	Power Supply for system 3.3V	
2	GND	P	Ground	
3	RxIN0-	I	LVDS Data Differential Pair 0 input	
4	RxIN0+	I	LVDS Data Differential Pair 0 input	
5	GND	P	Ground	
6	RxIN1-	I	LVDS Data Differential Pair 1 input	
7	RxIN1+	I	LVDS Data Differential Pair 1 input	
8	GND	P	Ground	
9	RxIN2-	I	LVDS Data Differential Pair 2 input	
10	RxIN2+	I	LVDS Data Differential Pair 2 input	
11	GND	P	Ground	
12	RxCLK-	I	Negative LVDS differential clock input	
13	RxCLK+	I	Positive LVDS differential clock input	
14	GND	P	Ground	
15	RxIN3-	I	LVDS Data Differential Pair 3 input	
16	RxIN3+	I	LVDS Data Differential Pair 3 input	
17	GND	P	Ground	
18	LED_A	P	Power for LED backlight anode	
19	LED_K	I	Power for LED backlight cathode	
20	GND	P	Ground	

I: Input, O: Output, P: Power

Notes: VSS Pin must ground contact, cannot be floating.

5.2 Block Diagram

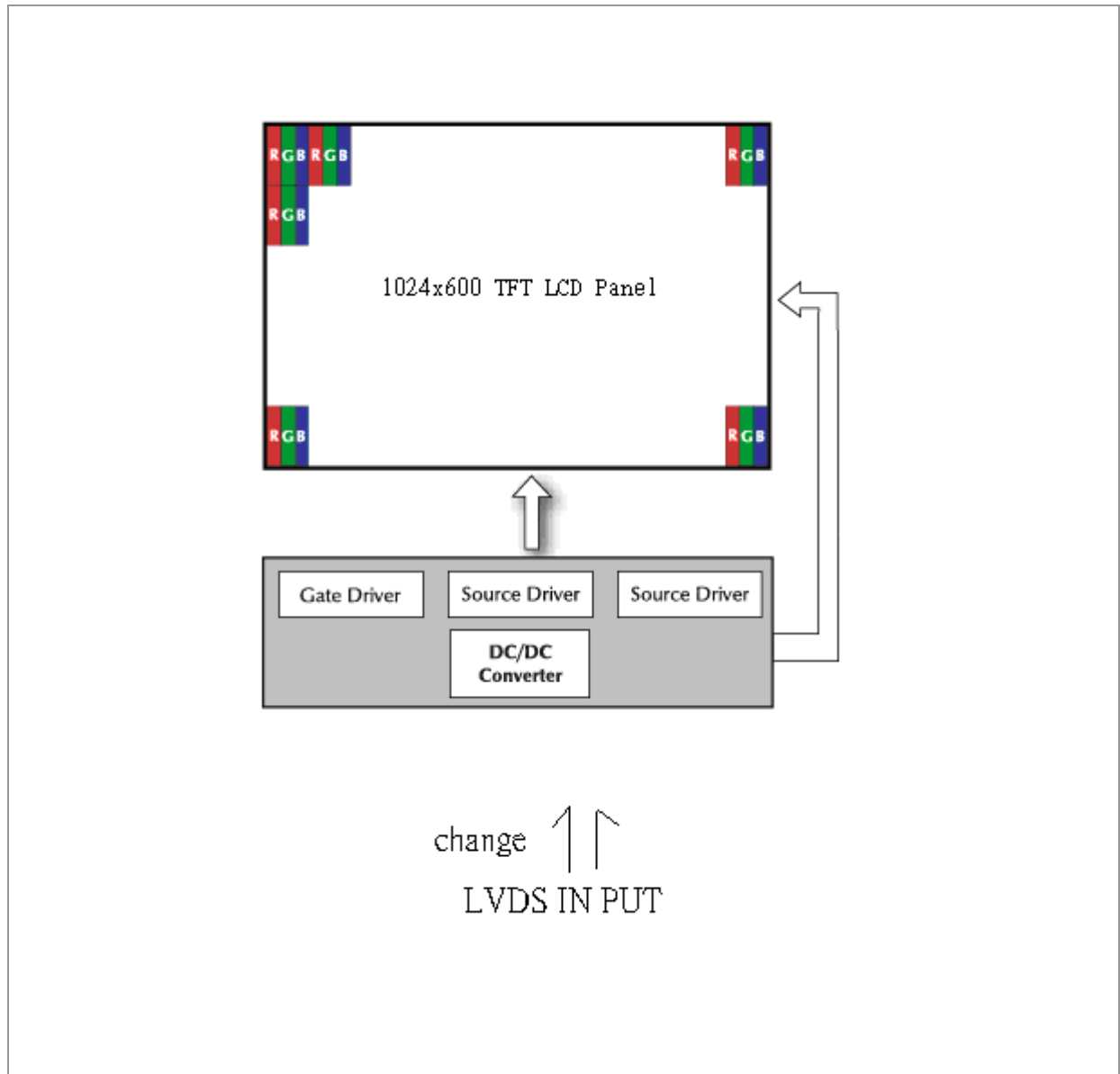

6. Displayed Color and Input Data

	Color & Gray Scale	Data Signal																							
		R7	R6	R5	R4	R3	R2	R1	R0	G7	G6	G5	G4	G3	G2	G1	G0	B7	B6	B5	B4	B3	B2	B1	B0
Basic Color	Black	0	0	0	0	0	0	0	0	0	0	0	0	0	0	0	0	0	0	0	0	0	0	0	0
	Red	1	1	1	1	1	1	1	1	0	0	0	0	0	0	0	0	0	0	0	0	0	0	0	0
	Green	0	0	0	0	0	0	0	0	1	1	1	1	1	1	1	1	0	0	0	0	0	0	0	0
	Blue	0	0	0	0	0	0	0	0	0	0	0	0	0	0	0	0	1	1	1	1	1	1	1	1
	Cyan	0	0	0	0	0	0	0	0	1	1	1	1	1	1	1	1	1	1	1	1	1	1	1	1
	Magenta	1	1	1	1	1	1	1	1	0	0	0	0	0	0	0	0	1	1	1	1	1	1	1	1
	Yellow	1	1	1	1	1	1	1	1	1	1	1	1	1	1	1	1	0	0	0	0	0	0	0	0
	White	1	1	1	1	1	1	1	1	1	1	1	1	1	1	1	1	1	1	1	1	1	1	1	1
Red	Black	0	0	0	0	0	0	0	0	0	0	0	0	0	0	0	0	0	0	0	0	0	0	0	
	Red(1)	0	0	0	0	0	0	0	1	0	0	0	0	0	0	0	0	0	0	0	0	0	0	0	
	Red(2)	0	0	0	0	0	0	1	0	0	0	0	0	0	0	0	0	0	0	0	0	0	0	0	
	:	:	:	:	:	:	:	:	:	:	:	:	:	:	:	:	:	:	:	:	:	:	:	:	
	Red(127)	0	1	1	1	1	1	1	1	0	0	0	0	0	0	0	0	0	0	0	0	0	0	0	
	:	:	:	:	:	:	:	:	:	:	:	:	:	:	:	:	:	:	:	:	:	:	:	:	
	Red(254)	1	1	1	1	1	1	1	0	0	0	0	0	0	0	0	0	0	0	0	0	0	0	0	
	Red(255)	1	1	1	1	1	1	1	1	0	0	0	0	0	0	0	0	0	0	0	0	0	0	0	
Green	Black	0	0	0	0	0	0	0	0	0	0	0	0	0	0	0	0	0	0	0	0	0	0	0	
	Green(1)	0	0	0	0	0	0	0	0	0	0	0	0	0	0	0	1	0	0	0	0	0	0	0	
	Green(2)	0	0	0	0	0	0	0	0	0	0	0	0	0	0	1	0	0	0	0	0	0	0	0	
	:	:	:	:	:	:	:	:	:	:	:	:	:	:	:	:	:	:	:	:	:	:	:	:	
	Green(127)	0	0	0	0	0	0	0	0	0	1	1	1	1	1	1	1	0	0	0	0	0	0	0	
	:	:	:	:	:	:	:	:	:	:	:	:	:	:	:	:	:	:	:	:	:	:	:	:	
	Green(254)	0	0	0	0	0	0	0	0	1	1	1	1	1	1	1	0	0	0	0	0	0	0	0	
	Green(255)	0	0	0	0	0	0	0	0	1	1	1	1	1	1	1	1	0	0	0	0	0	0	0	
Blue	Black	0	0	0	0	0	0	0	0	0	0	0	0	0	0	0	0	0	0	0	0	0	0	0	
	Blue(1)	0	0	0	0	0	0	0	0	0	0	0	0	0	0	0	0	0	0	0	0	0	0	1	
	Blue(2)	0	0	0	0	0	0	0	0	0	0	0	0	0	0	0	0	0	0	0	0	0	0	1	
	:	:	:	:	:	:	:	:	:	:	:	:	:	:	:	:	:	:	:	:	:	:	:	:	
	Blue(127)	0	0	0	0	0	0	0	0	0	0	0	0	0	0	0	0	0	1	1	1	1	1	1	
	:	:	:	:	:	:	:	:	:	:	:	:	:	:	:	:	:	:	:	:	:	:	:	:	
	Blue(254)	0	0	0	0	0	0	0	0	0	0	0	0	0	0	0	0	1	1	1	1	1	1	0	
	Blue(255)	0	0	0	0	0	0	0	0	0	0	0	0	0	0	0	0	1	1	1	1	1	1	1	

0 : Low level voltage, 1 :High level voltage

Each basic color can be displayed in 256 gray scales from 8 bit data signals. With the combination of total 24 bit data signals, the 16.7M-color display can be achieved on the screen.

7. Reliability Condition

No change on display and in operation under the following test condition.

Condition: Unless otherwise specified, tests will be conducted under the following condition.

Temperature: 20°C ± 5°C.

Humidity: 65% ± 5%RH.

Tests will be not conducted under functioning state.

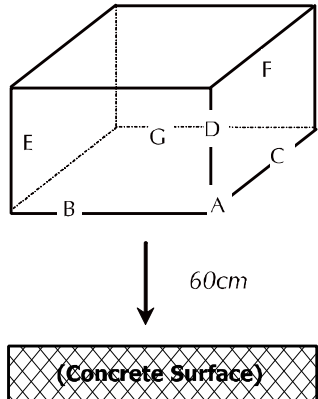
No.	Parameter	Condition	Notes
1	High Temperature Operating	70°C ± 2°C, 240hrs	
2	Low Temperature Operating	-20°C ± 2°C, 240hrs	1
3	High Temperature Storage	80°C ± 2°C, 240hrs.	2
4	Low Temperature Storage	-30°C ± 2°C, 240hrs.	1,2
5	High Temperature and High Humidity Operation Test	60°C ± 2°C, 90%, 240hrs.	1,2
6	Vibration Test	Total fixed amplitude: 1.5mm. Vibration Frequency: 10~55Hz. One cycle 60 seconds to 3 direction of X, Y, Z each 15 minutes.	3
7.	Drop Test	To be measured after dropping from 60cm high on the concrete surface in packing state.  <p><i>Dropping method corner dropping:</i> <i>A corner: Once edge dropping.</i> <i>B, C, D edge: Once face dropping.</i> <i>E, F, G face: Once.</i></p>	

- Notes:
1. No dew condensation to be observed.
 2. The function test shall be conducted after 4 hours storage at the normal temperature and humidity after removed from the test chamber.
 3. Vibration test will be conducted to the product itself without putting I in a container.

8. Dimensional Outlines

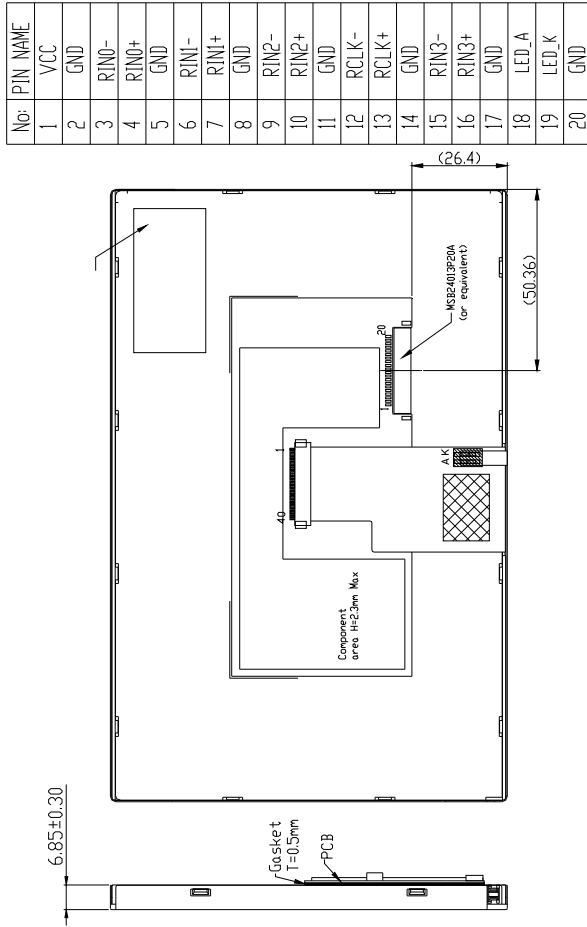
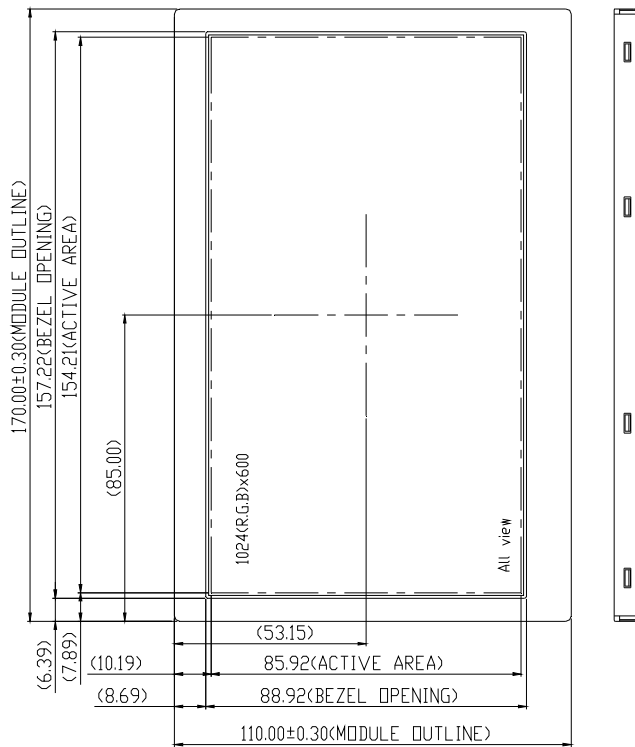

No.	PIN NAME
1	VCC
2	GND
3	RIN0-
4	RIN0+
5	GND
6	RIN1-
7	RIN1+
8	GND
9	RIN2-
10	RIN2+
11	GND
12	RCLK-
13	RCLK+
14	GND
15	RIN3-
16	RIN3+
17	GND
18	LED_A
19	LED_K
20	GND

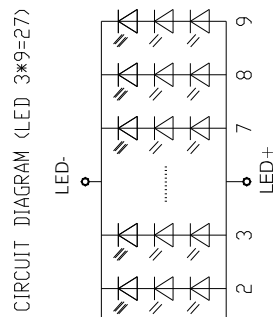

Display type	7" TFT-IPS
Resolution	1024xRGBx600
Driver IC	Source IC:ST5651CB Gate IC:ST5021
Display mode	Normally Black
Viewing Direction	All view
Viewing Angle(U/D/L/R)	85/85/85/85
Brightness(Center point)	1000cd/m ² Typ.
Color Chromaticity	x=0.31±0.05, y=0.34±0.05
Backlight	LED 27pcs, 3S9P
Operating Temperature	-20~+70°C
Storage Temperature	-30~+80°C
Interface	LVDS

9. Incoming Inspection Standards

9.1 Inspection and Environment Conditions

9.1.1 Inspection Conditions:

- (1) Inspection Distance: 35 cm±5cm
- (2) View Angle : Light-on Inspection Angle : ±5°
Cosmetic Inspection Angle : ±45°

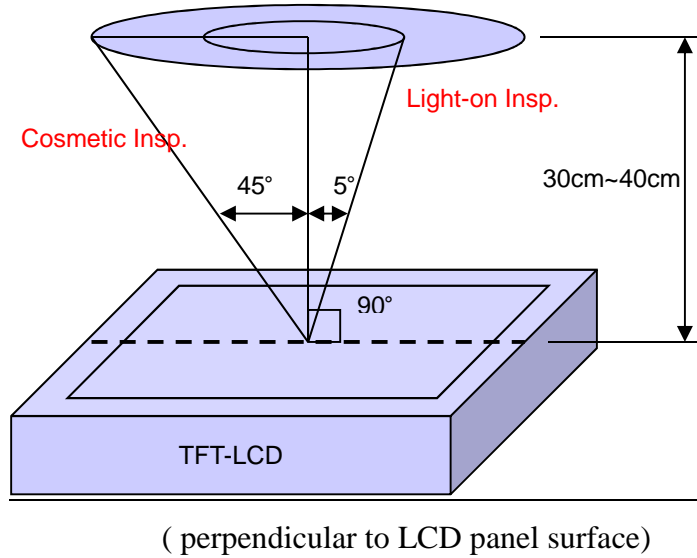

9.1.2 Environment Conditions:

Ambient Temperature		23°C ± 5°C
Ambient Humidity		55% ± 10%RH
Ambient Illumination	Cosmetic Inspection	more than 600 Lux
	Functional Inspection	300~500 Lux

9.1.3 Sampling Conditions:

- (1) Lot Size: Quantity of shipment lot per model
- (2) Sampling Method:

Sampling Plan		MIL-STD-105E
		Normal Inspection, Single Sampling
		Level II
AQL	Major Defect	1.0%
	Minor Defect	1.5%

- (3) The classification of Major(MA) and Minor(MI) defects is shown as 3. Inspection Criteria.

9.1.4 Inspection Criteria

9.1.4.1 Cosmetic Inspection(Panel):

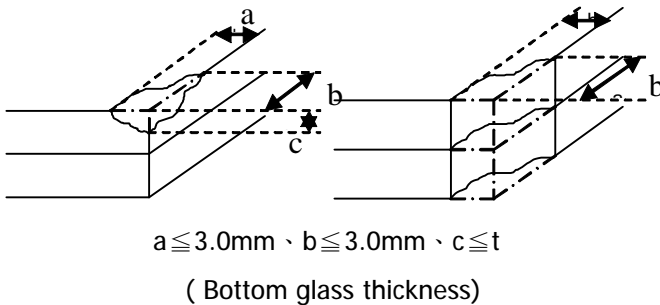
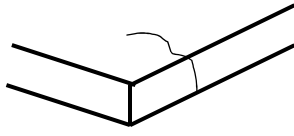
Item	Judgment Criteria	Classification
Chipping on Panel	 <p>$a \leq 3.0\text{mm}$、$b \leq 3.0\text{mm}$、$c \leq t$ (Bottom glass thickness)</p>	MA
Scratch on Panel *Note-2	$W \leq 0.05\text{mm}$ or $L < 5\text{mm}$: Ignored $0.05\text{mm} < W \leq 0.1\text{mm}$ and $L \leq 5\text{mm}$: $N \leq 5$ $W > 0.1\text{mm}$ or $L > 5\text{mm}$: Not allowed	MI
Bubble or Dent on Panel *Note-3	$D \leq 0.2\text{mm}$: Ignored $0.2\text{mm} < D \leq 0.3\text{mm}$: $N \leq 5$ $D > 0.3\text{mm}$: Not allowed	MI
Panel Crack	 <p>Not Allowed crack</p>	MA
Bezel Deformation	Obvious deformation is not allowed.	MI
Bezel Oxidation	Not allowed if it rusts continuously over 1 cm (It is out of warranty with rusted tin plate)	MI
Bezel Scratch	$L \leq 20\text{mm}$, $W \leq 0.2$, $N \leq 3$	MI
Metal Squash Dent /Flange(Front Side)	$D(W) \leq 1$, $L \leq 3$, $N \leq 3$;	MI
B/L High Voltage Wire Denudation	Not allowed	MA
Polarizer flaw or leak out resin	Defect is defined as the active area.	MI
Outline Dimension	Must in Spec, refer to related product spec.	MI

9.1.4.2 Functional Inspection:

Item	Judgment Criteria			Classification	
	Area(Note1)	I	O		
Point Defect	Bright dot	Random	2		MI
		2 dots adjacent	0	0	
		3 dots adjacent or more	0	0	
	Dark dot	Random	3		
		2 dots adjacent	1		
		3 dots adjacent or more	0	0	
	Total Dot Defect		5		
	Distance	Distance between Bright and Bright dot	$L \geq 5\text{mm}$		
		Distance between Bright and Dark dot	$L \geq 5\text{mm}$		
		Distance between Dark dot	$L \geq 5\text{mm}$		
(1) It is defined as Point Defect if defect area $> 0.5\text{dot}$ (2) It is ignored if defect area $\leq 0.5\text{dot}$ (3) Weak point defect will be defined as Bright Dot if it can be observed through ND filter 5% (Full Screen Black Inspection)					
Line Defect	Obvious vertical or horizontal line defect is not allowed.			MA	
Mura	Not allowed if it can be observed through ND Filter 5 %			MI	
Foreign Material in spot shape *Note-3	$D \leq 0.2\text{mm}$: Ignored $0.2\text{mm} < D \leq 0.5\text{mm}$: $N \leq 8$ $D > 0.5\text{mm}$: Not allowed			MI	
Foreign Material in line or spiral shape *Note-4	$W \leq 0.05\text{mm}$ or $L \leq 5\text{mm}$: Ignored $0.05\text{mm} < W \leq 0.2\text{mm}$ and $L 1.0\text{mm} \leq 5\text{mm}$: $N \leq 8$ $W > 0.2\text{mm}$ or $L > 5\text{mm}$: Not allowed			MI	
Display Function Abnormal	No Malfunction can be allowed			MA	

Note-1 : I/O Area Definition

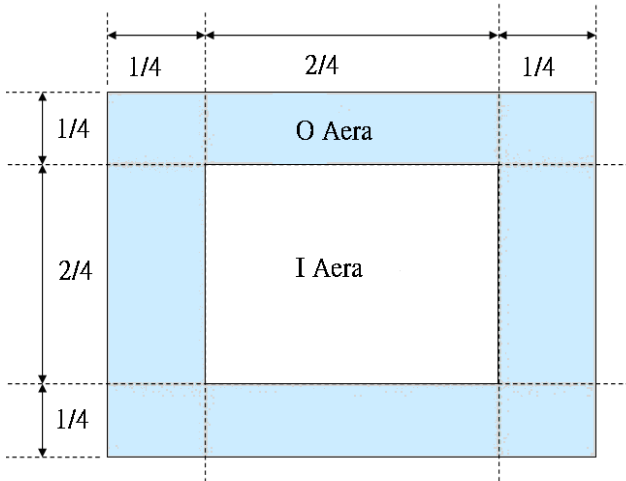

Note-2 : Polarizer Scratch

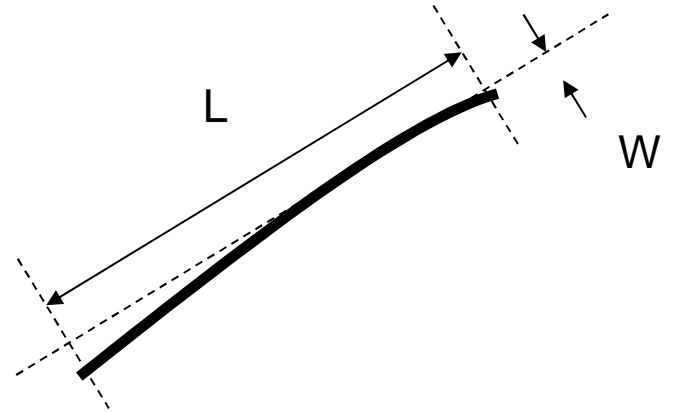

Note-3 : Spot Foreign Material
($W \geq L / 4$)

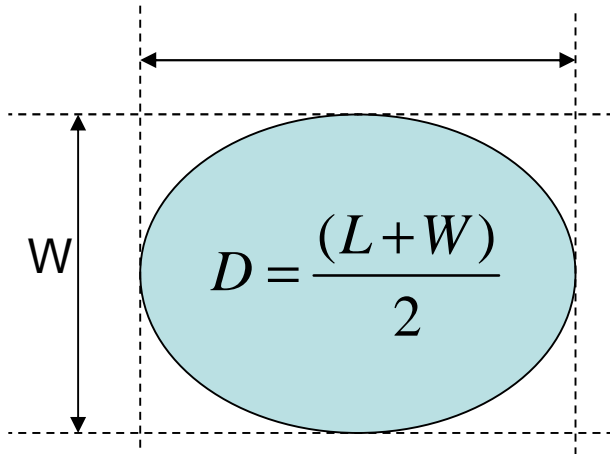

Note-4 : Line or Spiral Foreign Material
($W < L / 4$)

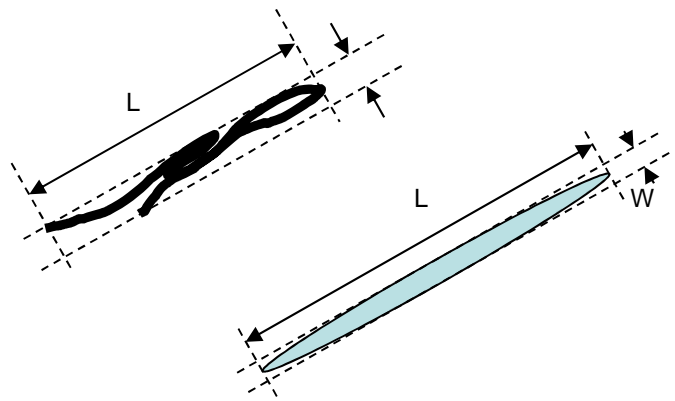

X-ON Electronics

Largest Supplier of Electrical and Electronic Components

Click to view similar products for [TFT Displays & Accessories](#) category:

Click to view products by [Display Elektronik](#) manufacturer:

Other Similar products are found below :

[OAI-80038AA-2013-A](#) [HDA430T-3G1H](#) [EA CARREDIPTFT02](#) [NL6448BC20-21D](#) [NB7W-KBA04](#) [NB-ATT01](#) [NB5Q-ATT01](#) [NB5Q-KBA04](#) [NB-CN001](#) [NL12880BC20-05](#) [NL8060BC26-35C](#) [NL8060BC26-35F](#) [TCG104SVLQAPNN-AN20](#) [OAI-80038AA-2008-A](#) [315-U004B15300](#) [UMSH-8596MD-34T \(REV D\)](#) [98-0003-3490-8](#) [1044278](#) [1029309](#) [1060549](#) [DE 127-TU-30/7,5](#) [DE 128-TU-20/7,5](#) [EP-LK007TFTPCAP](#) [FR7.0A00](#) [RC2002A-TIG-CSX](#) [NL6448BC2021C](#) [TX17D01VM2EAB](#) [TX14D23VM5BAA](#)
[TCG121WXLRXVNNANX35](#) [EIC-LCD-1080P](#) [T272480C07VR01](#) [1060632](#) [TCG070WVLPAANN-AN50](#) [TCG035QVLPDANN-GN50](#)
[1060630](#) [RFE430V-AIW-DNG](#) [T-55619GD065J-LW-ABN](#) [NHD-1.8-128160EF-SSXN-FT](#) [TCG104SVLPEANN-AN30](#) [NL6448BC33-70](#)
[NL192108BC18-06F](#) [NLB150XG02L-01](#) [NL6448BC20-30D](#) [NL10276BC16-06](#) [NL192108AC10-01D](#) [NL6448AC18-08F](#) [NL6448BC20-30F](#)
[NL12880BC20-05BD](#) [NL12880BC20-05D](#) [NL8060BC26-35BA](#)