

DISPLAY Elektronik GmbH

DATA SHEET

LCD MODULE

**DEM 1024600M2 VMH-PW-N
(A-TOUCH)**

Product Specification

Version: 1

13.05.2020

CONTENTS

1. GENERAL SPECIFICATIONS..... 2

2. EXTERNAL DIMENSIONS 4

3. BLOCK DIAGRAM 6

4. PIN ASSIGNMENT 7

5. OPTICAL CHARACTERISTICS 10

6. ABSOLUTE MAXIMUM RATINGS 13

7. ELECTRICAL CHARACTERISTICS 13

8. RELIABILITY TEST 17

9. LCD MODULES HANDLING PRECAUTIONS..... 18

10. OTHERS 18

1. GENERAL SPECIFICATIONS

ITEM	STANDARD VALUE	UNIT
LCD TYPE	TFT/IPS/ NORMALLY BLACK/TRANSMISSIVE	
MODULE SIZE	164.80 x 99.80 x 7.00	mm
ACTIVE AREA	154.21 x 85.92	mm
PIXEL PITCH (W*H)	0.1506 x 0.1432	
NUMBER OF PIXELS	1024 x 3(RGB) x 600	
DIVER IC	EK73215 + EK79001H	
INTERFACE TYPE	LVDS	
RECOMMEND VIEWING DIRECTION	ALL	O'CLOCK
GRAY SCALE INVERSION DIRECTION	-	O'CLOCK
COLORS	16.7 MILLION	
BACKLIGHT TYPE	30-DIES WHITE LED	
TOUCH PANEL TYPE	RTP	

Touch Panel Features:

Type:	4-Wire Analogy Resistive Touch Panel
Input Mode:	Stylus or Finger
ITO Film:	0.2 mm (T)
ITO Glass:	1.1 mm (T)
Connector:	FPC

Touch Panel Mechanical Characteristics

Surface Hardness: 3H or more (according to JIS-K5400).

Touch Panel Optical Characteristics

Transmittance: 80% Typical.

Touch Panel Rating

1. Maximum Voltage
Less than DC 7 volts.
2. Operating Temperature Range
- 20°C to 70°C (Humidity: 20% RH to 70% RH, No condensation of dew).
3. Storage Temperature Range
- 30°C to 80°C (Humidity: 20% RH to 80% RH, No condensation of dew).

Electrical Characteristics

1. Resistance between Terminals
Direction "X": 440~980Ω
Direction "Y": 140~310Ω
2. Linearity
X axis: $\leq \pm 1.5\%$
Y axis: $\leq \pm 1.5\%$
3. Insulation Resistance: 20MΩ or more at DC 25 V.
4. Chattering Time: 10 msec or less at 100kΩ Pull-up.

2. EXTERNAL DIMENSIONS

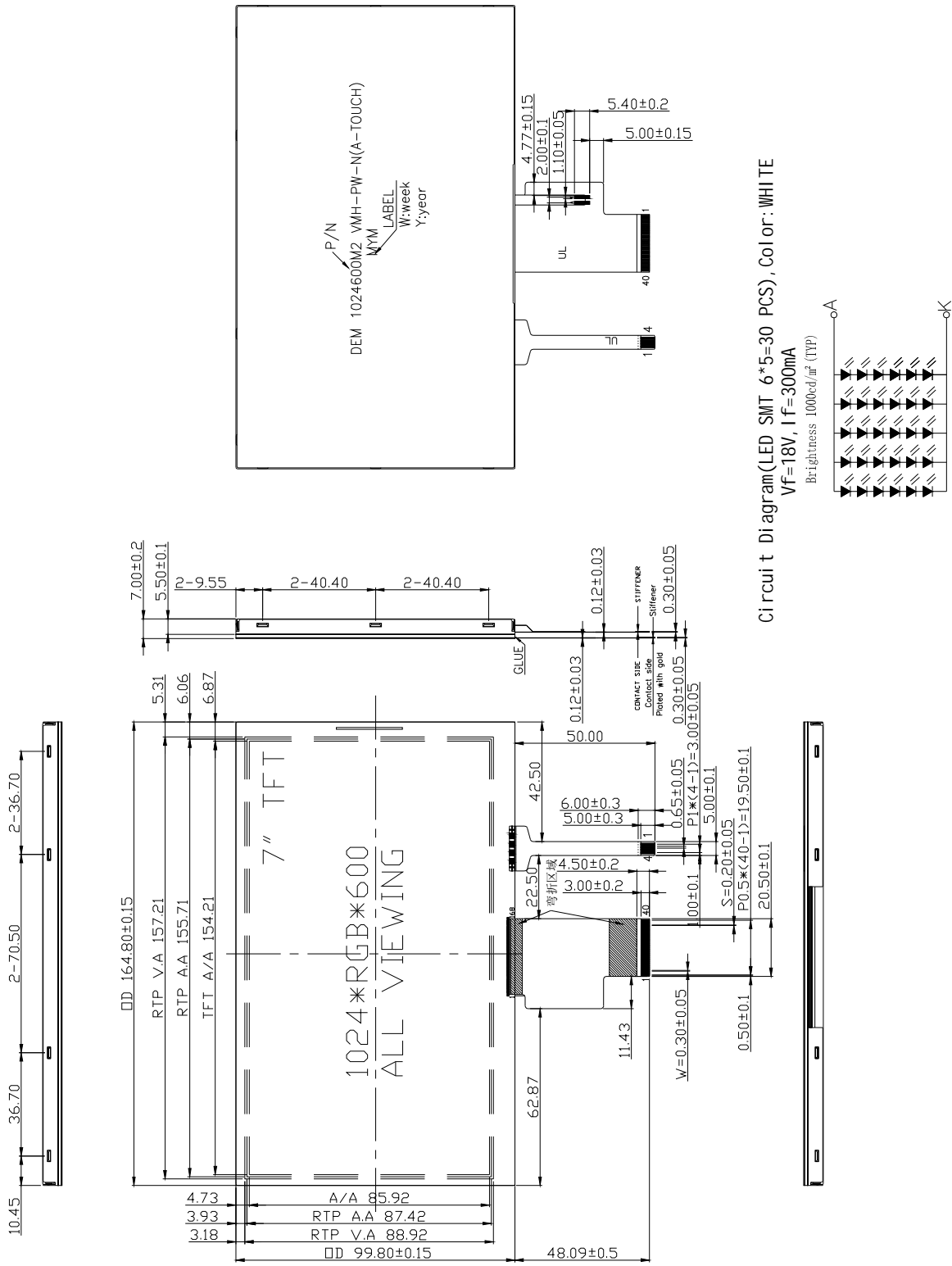

Circuit Diagram(LED SMT 6*5=30 PCS), Color: WHITE
 Vf=18V, If=300ma
 Brightness 1000cd/m² (TIP)

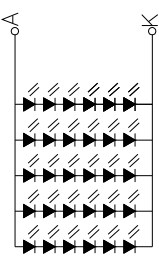

Remark:

- 1.Unmarked tolerance is ±0.3
- 2.All materials comply with RoHS

Touch Panel:

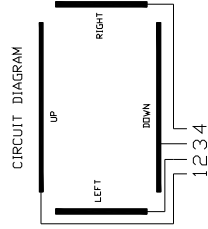
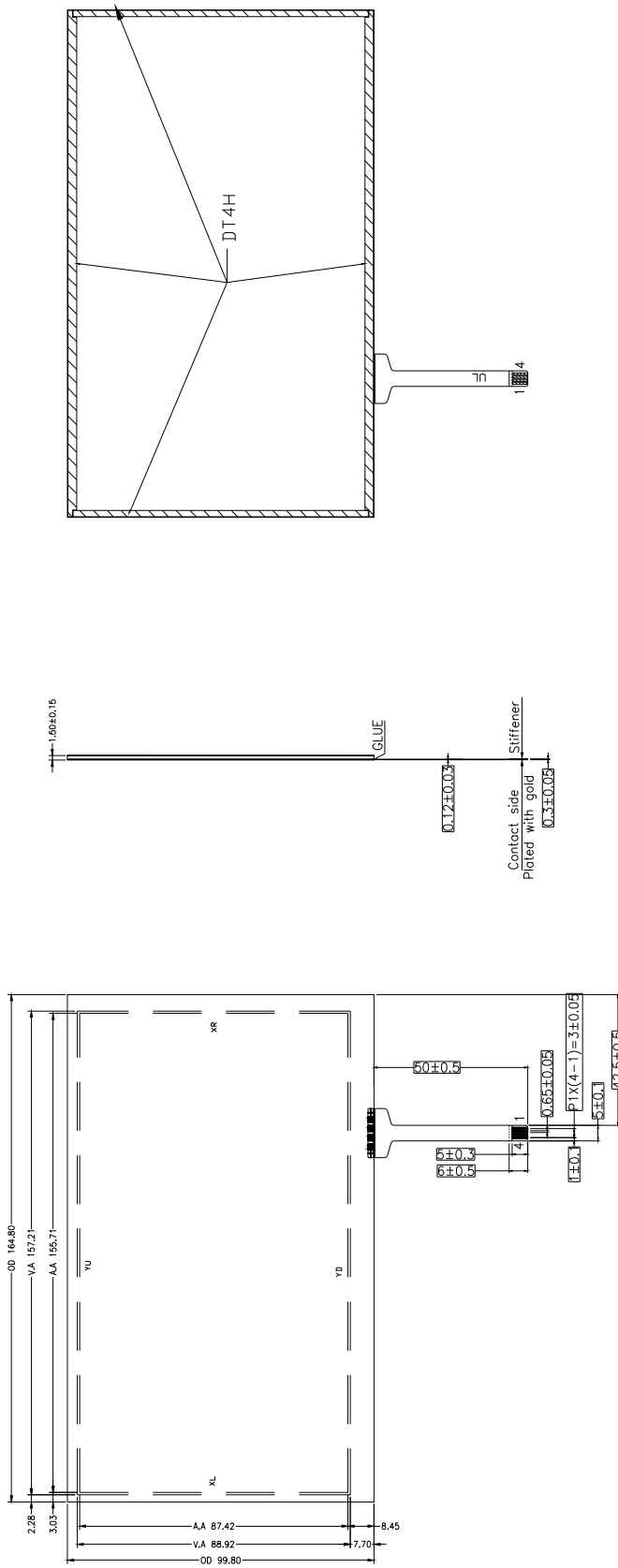

SIGNAL ASSIGNMENT	
PIN	SYMBOL NAME
1	YU UP
2	XL LEFT
3	YD DOWN
4	XR RIGHT

- REMARK:
1. Glass THK:1.1mm
 2. Total THK:1.5±0.15mm
 3. Linearity:±1.5% or less
 4. Transmittance:80% Typical
 5. Resistance
440<X<980 ohm
140<Y<310 ohm
 6. Connector:FPC
 7. For prevention of detach of FPC from Glass,add taping and gluing(Like LCD module)
 8. Operating Force:20~100g
Silicon Rubber Measuring Head Contact Area: $\varnothing 0.3\text{mm} \sim \varnothing 0.8\text{mm}$
 9. General Tolerance:±0.3mm.
 10. All materials comply with RoHS
 11. ...critical dimension.

RTP07013

3. BLOCK DIAGRAM

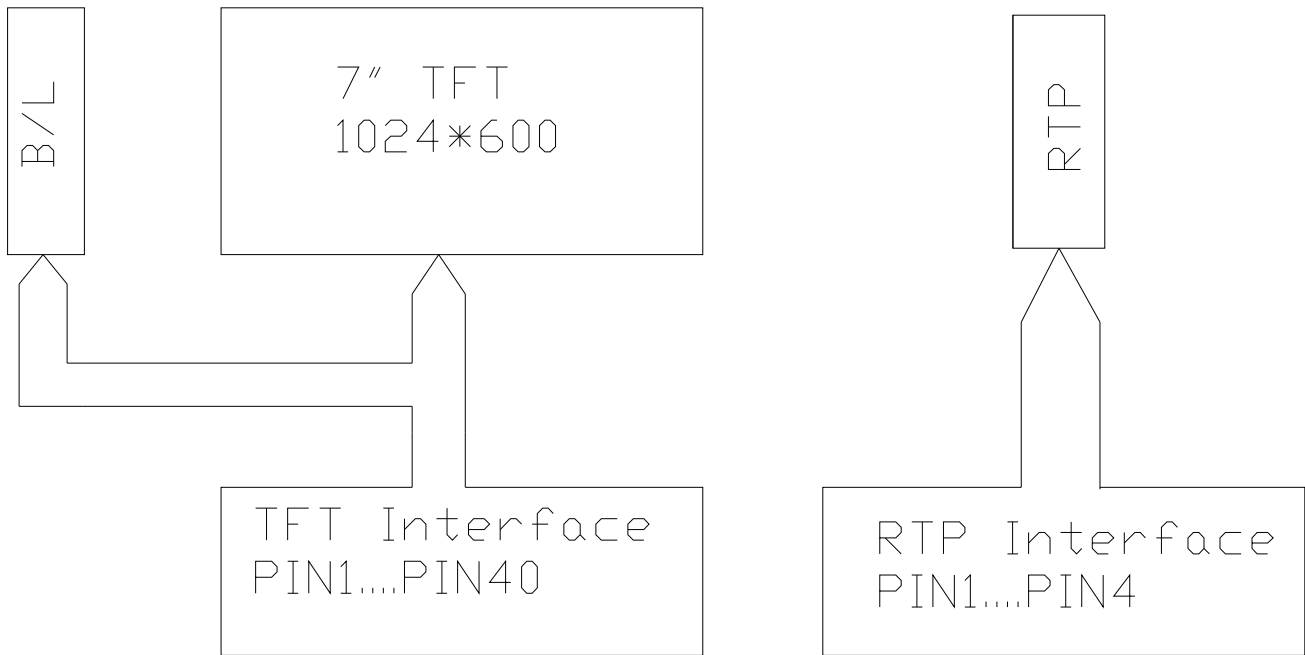

4. PIN ASSIGNMENT

PIN NO.	SYMBOL	DESCRIPTION
1	VCOM	Common Voltage
2	VDD	Power Supply
3	VDD	Power Supply
4	NC	Not Connection
5	RESET	Reset Pin
6	STBYB	Standby mode, normally pulled high. STBYB = "1", normal operation STBYB = "0", timing controller, source driver will turn off, all output are High-Z
7	GND	Power Ground
8	RXIN0-	Data Lane0 Input
9	RXIN0+	Data Lane0 Input
10	GND	Power Ground
11	RXIN1-	Data Lane1 Input
12	RXIN1+	Data Lane1 Input
13	GND	Power Ground
14	RXIN2-	Data Lane2 Input
15	RXIN2+	Data Lane2 Input
16	GND	Power Ground
17	RXCLKIN-	CLK Input
18	RXCLKIN+	CLK Input
19	GND	Power Ground
20	RXIN3-	Data Lane3 Input
21	RXIN3+	Data Lane3 Input
22	GND	Power Ground
23	NC	Not Connection
24	NC	Not Connection
25	GND	Power Ground
26	NC	Not Connection
27	NC	Not Connection
28	SELB	In LVDS interface connected HSD to FPC for Pin Setting SELB="L":8 bit SELB="H":6 bit
29	AVDD	Power for Analog Circuit
30	GND	Power Ground
31	LED-	LED Cathode

32	LED-	LED Cathode
33	L/R	Source Right or Left sequence control. Normally pull high. L/R = "L", shift left: last data = S1←S2←S3.....←S1200 = first data. L/R = "H", shift right: first data = S1→S2→S3.....→S1200 = last data
34	U/D	Gate Up or Down scan control. Normally pull low. UPDN = "L", STV2 output vertical start pulse and UD pin output logical "0" to Gate driver.(Default) UPDN = "H", STV1 output vertical start pulse and UD pin output logical "1" to Gate driver.
35	VGL	Gate OFF Voltage
36	NC	Not Connection
37	NC	Not Connection
38	VGH	Gate ON Voltage
39	LED+	LED Anode
40	LED+	LED Anode

SELECTION OF SCANNING MODE

SETTING OF SCAN CONTROL INPUT		SCANNING DIRECTION
U/D	L/R	
GND	DVDD	UP TO DOWN, RIGHT TO LEFT
DVDD	GND	DOWN TO UP, LEFT TO RIGHT
GND	GND	UP TO DOWN, LEFT TO RIGHT
DVDD	DVDD	DOWN TO UP, RIGHT TO LEFT

DEFINITION OF SCANNING DIRECTION REFER TO THE FIGURE AS BELOW:

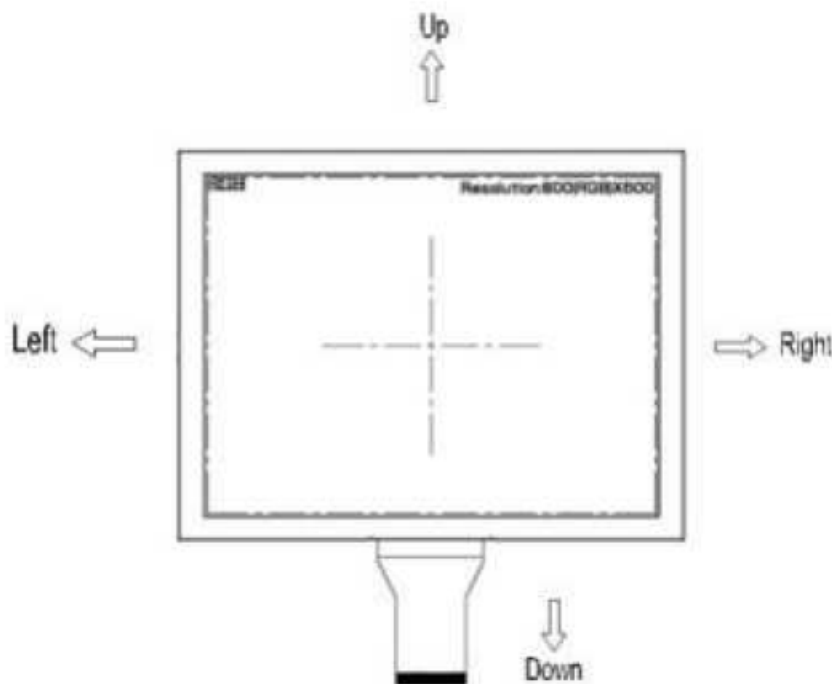

Touch Panel:

PIN NO.	SYMBOL	DESCRIPTION
1	YU	Touch Panel Pin UP
2	XL	Touch Panel Pin LEFT
3	YD	Touch Panel Pin DOWN
4	XR	Touch Panel Pin RIGHT

5. OPTICAL CHARACTERISTICS

ITEM	SYMBOL	CONDITIONS	SPECIFICATIONS			UNIT	NOTE
			MIN	TYP.	MAX		
Luminance	L		640	800	-	Cd/m ²	
Contrast Ratio	CR	$\theta = 0^\circ$	640	800			
Response Time	Rising	T _R	25°C	4	8	ms	
	Falling	T _F		12	24		
CIE COLOUR COORDINATE	RED	XR	VIEWING NORMAL ANGLE				
		YR					
	GREEN	XG					
		YG					
	BLUE	XB					
		YB					
	WHITE	XW					
		YW					
VIEWING ANGLE	Hor.	θ_{x+}	CR ≥ 10	80	85	Degree	
		θ_{x-}		80	85		
	Ver.	θ_{y+}		80	85		
		θ_{y-}		80	85		

Note 1 : Definition of Viewing Angle θ_x and θ_y :

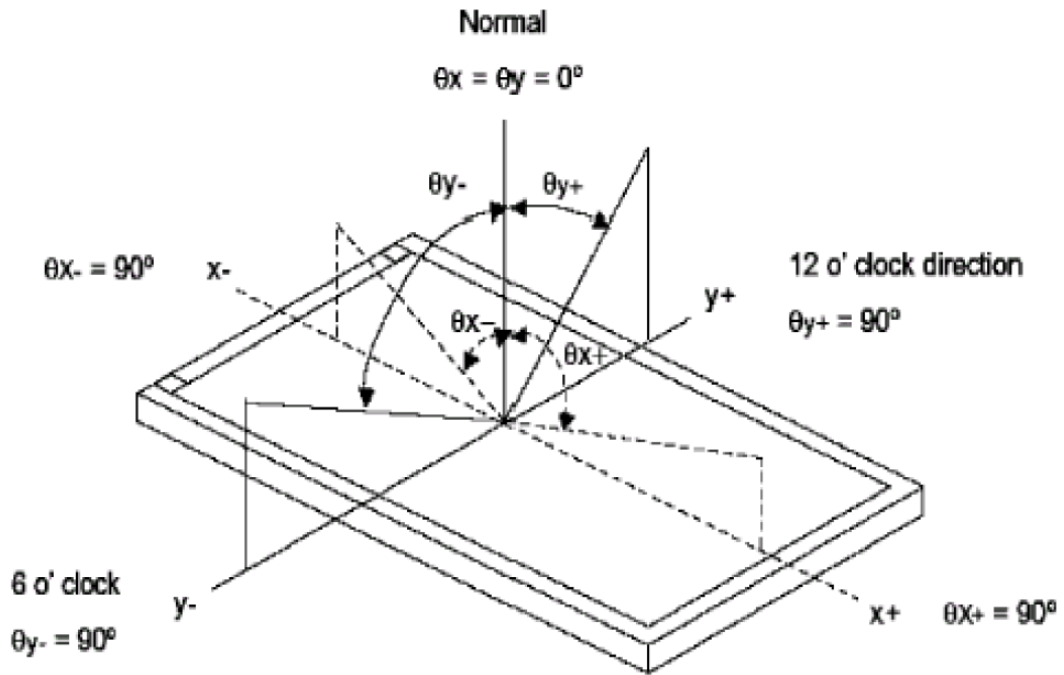

Note 2: Definition of contrast ratio CR:

$$CR = \frac{\text{Brightness of non-selected dots (white)}}{\text{Brightness of selected dots (black)}}$$

Note 3: Definition of response time (T_R , T_F)

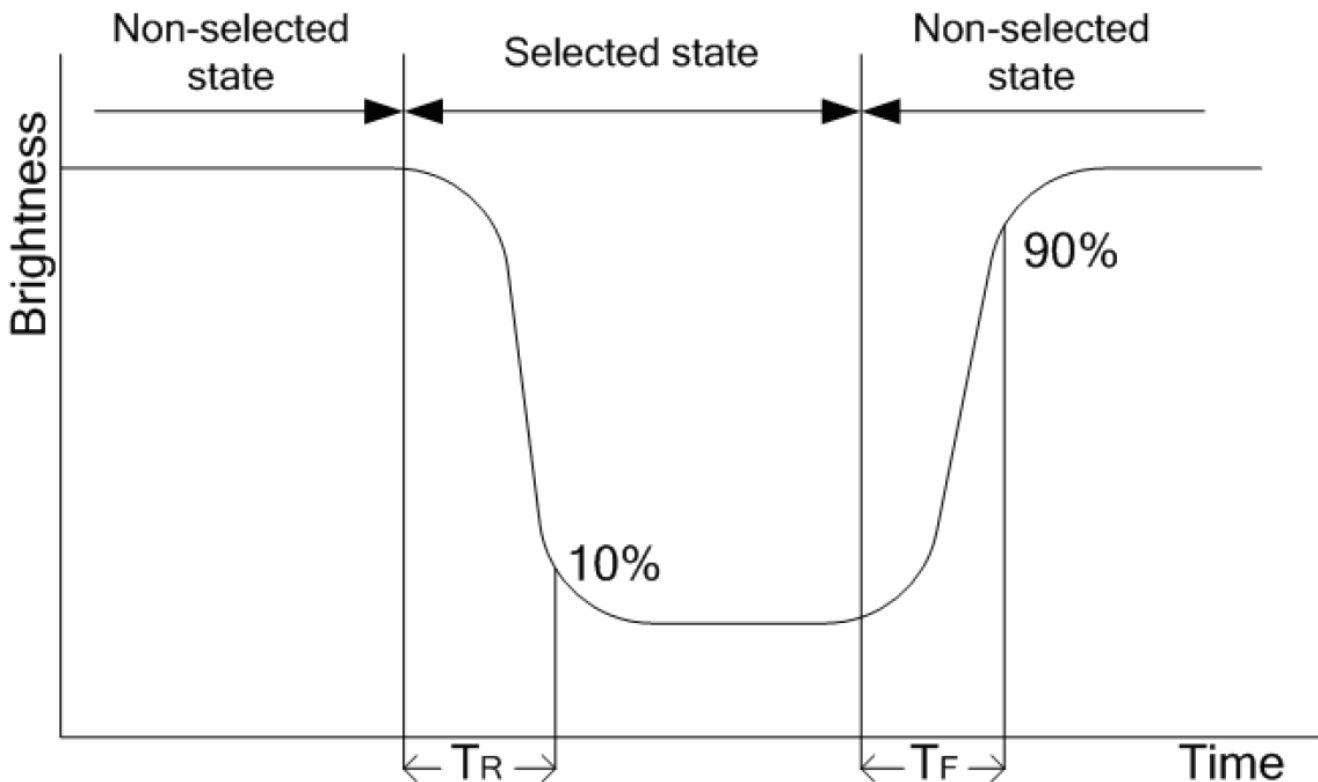

Note 4: Definition of Luminance

①The Brightness Test Equipment Setup

Field=2° (As measuring “black” image, field=2° is the best testing condition)

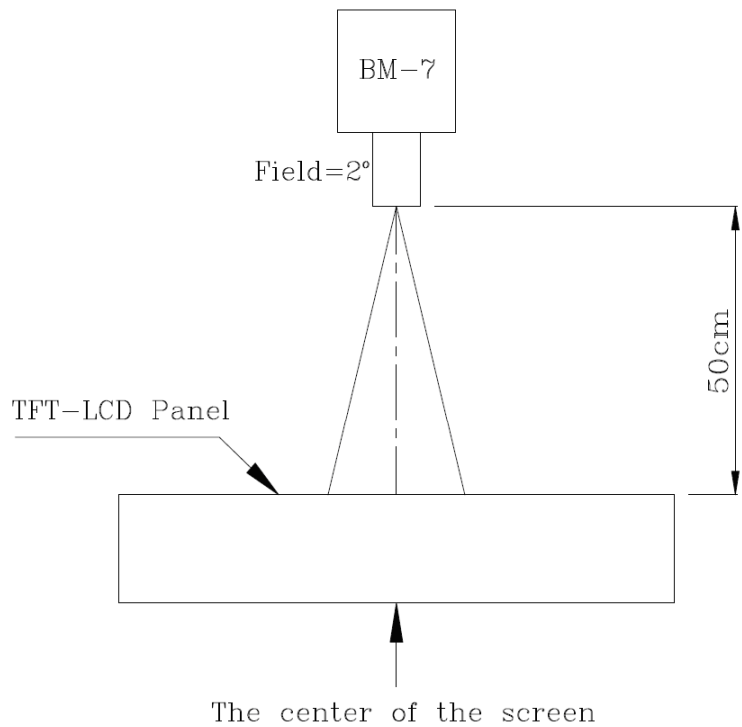

②The Brightness Test Point Setup

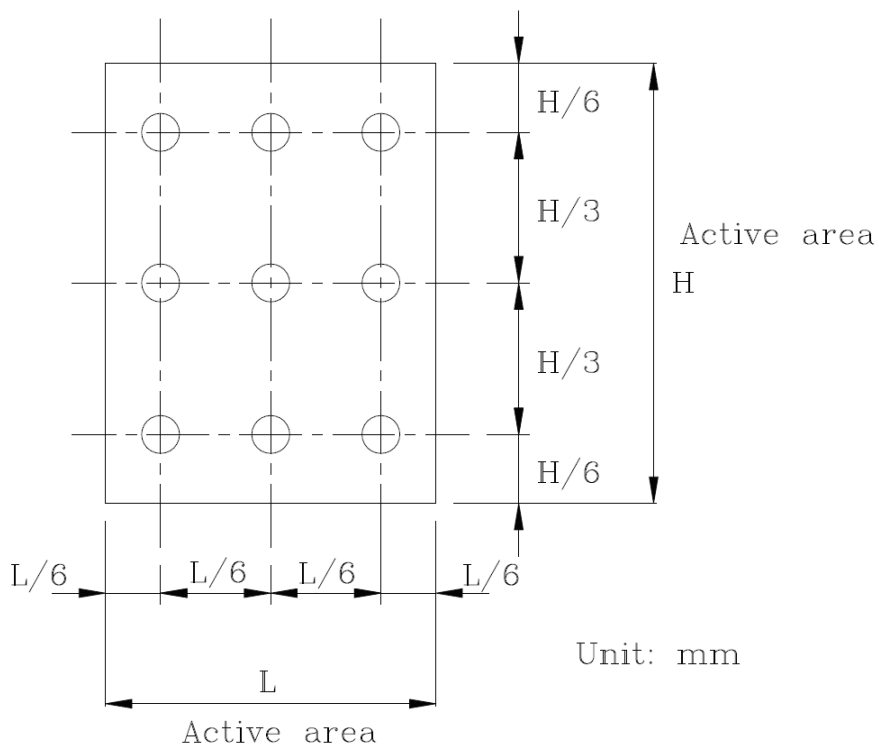

6. ABSOLUTE MAXIMUM RATINGS

PARAMETER	SYMBOL	MIN	MAX	UNIT
Power Supply Voltage	VDD	-0.5	5.0	V
Operating Temperature	Top	-20	+70	°C
Storage Temperature	Tst	-30	+80	°C

7. ELECTRICAL CHARACTERISTICS**7.1 BACKLIGHT DRIVING CONDITIONS**

ITEM	SYMBOL	SPECIFICATIONS			UNIT	REMARK
		MIN	TYP.	MAX		
Supply Voltage	Vf		18		V	
Supply Current	IL		300		mA	
Power Consumption	P		5.4		W	
LED Lifetime			50,000		H _r	

7.2 ELECTRICAL CHARACTERISTICS

ITEM	SYMBOL	MIN	TYP.	MAX	UNIT
Power Supply	VDD	3.0	3.3	3.6	V
	AVDD	8.9	9.0	9.1	V
	VGH	17	18	19	V
	VGL	-6.5	-6.0	-5.5	V
	VCOM	3.0	3.15	3.3	V
Input Voltage	Vil	GND	-	0.3VDD	V
	Vih	0.7VDD	-	VDD	V

7.3 TIMING CHARACTERISTICS

7.3.1 Vertical input timing

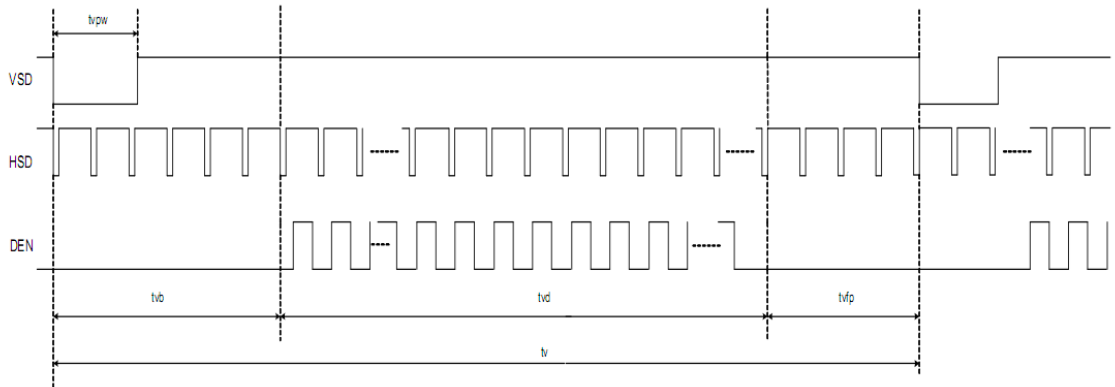

7.3.2 Horizontal input timing

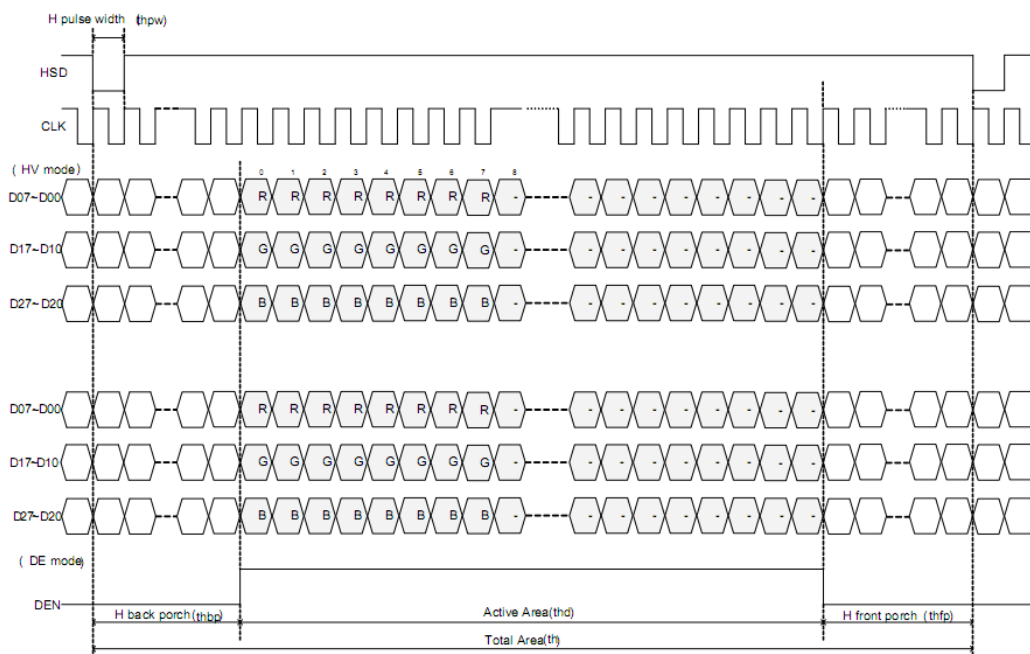

DE mode

DE mode					
Parameter	Symbol	Value			Unit
		Min.	Typ.	Max.	
DCLK frequency @Frame rate=60hz	fclk	40.8	51.2	67.2	Mhz
Horizontal display area	thd	1024			DCLK
HSYNC period time	th	1114	1344	1400	DCLK
HSYNC blanking	thb+thfp	90	320	376	DCLK
Vertical display area	tvd	600			H
VSYNC period time	tv	610	635	800	H
VSYNC blanking	tvb+tvfp	10	35	200	H

HV mode(1)

HV mode					
Horizontal input timing					
Parameter	Symbol	Value			Unit
Horizontal display area	thd	1024			DCLK
DCLK frequency@ Frame rate=60hz	fclk	Min.	Typ.	Max.	Mhz
		44.9	51.2	63	
1 Horizontal Line	th	1200	1344	1400	DCLK
HSYNC pulse width	thpw	Min.	1		
		Typ.	-		
		Max.	140		
HSYNC back porch	thbp	160	160	160	
HSYNC front porch	thfp	16	160	216	

HV mode(2)

Vertical input timing					
Parameter	Symbol	Value			Unit
		Min.	Typ.	Max.	
Vertical display area	tvd	600			H
VSYNC period time	tv	624	635	750	H
VSYNC pulse width	tpw	1	-	20	H
VSYNC back porch	tvb	23	23	23	H
VSYNC front porch	tvfp	1	12	127	H

DATE INPUT FORMAT

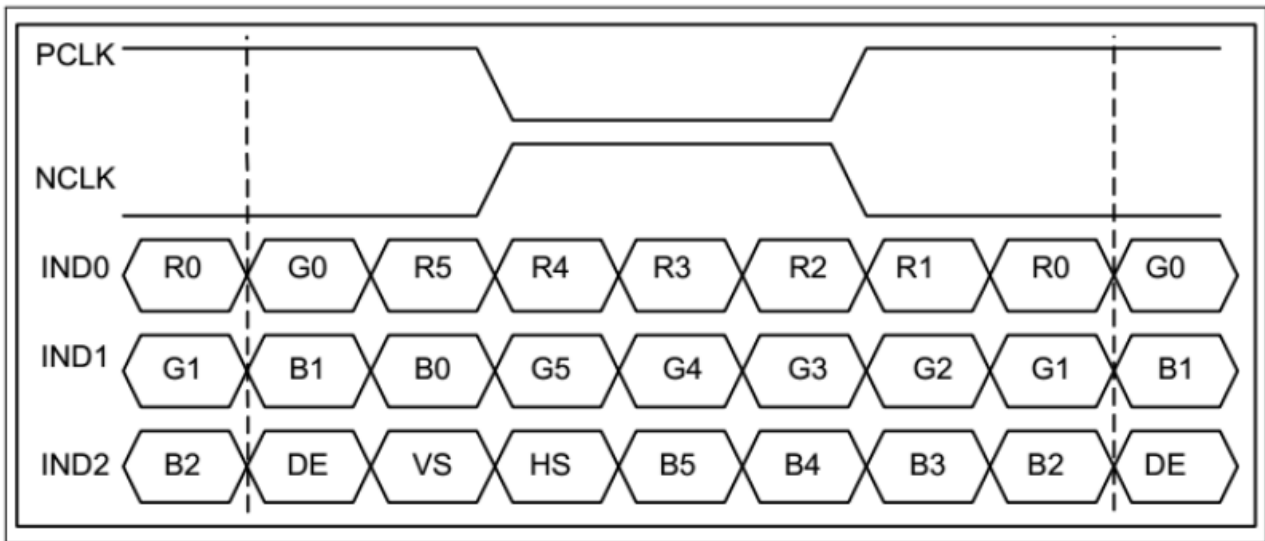

6-bit LVDS Input Timing chart

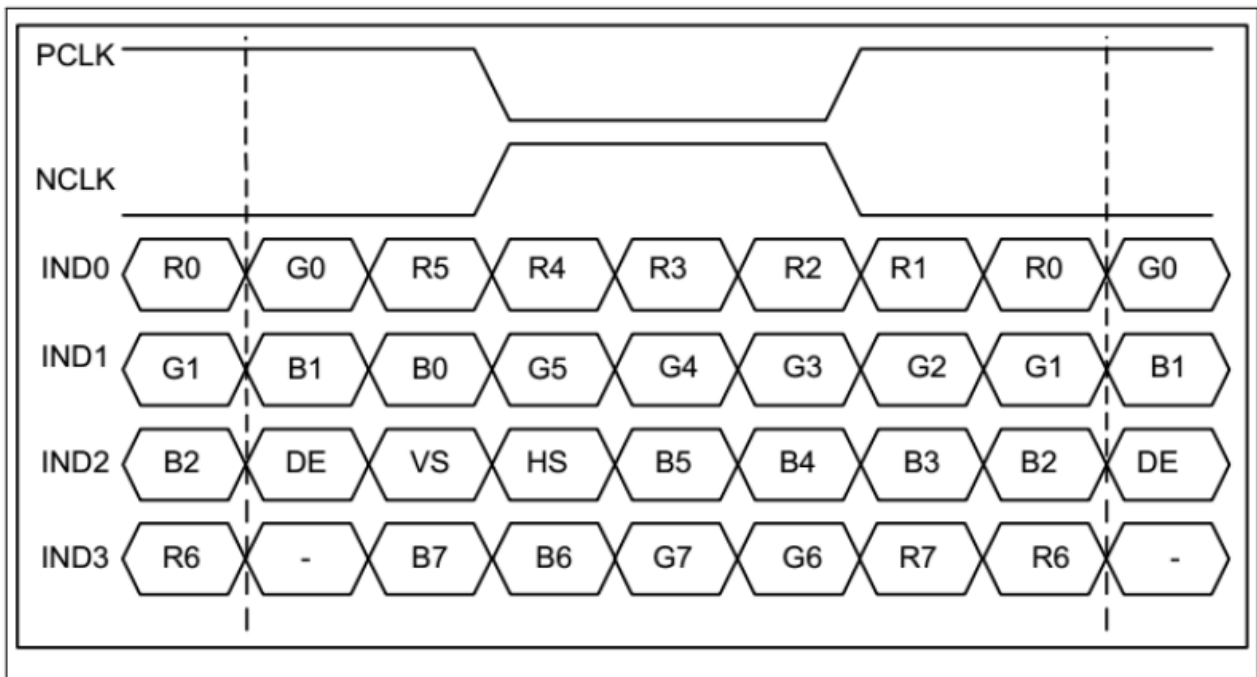

8-bit LVDS Input Timing chart

8. RELIABILITY TEST

NO.	TEST ITEM	CONDITIONS	
1	HIGH TEMPERATURE STORAGE	TA=80°C	96H
2	LOW TEMPERATURE STORAGE	TA=-30°C	96H
3	HIGH TEMPERATURE OPERATION	TA=70°C	96H
4	LOW TEMPERATURE OPERATION	TA=-20°C	96H
5	HIGH TEMPERATURE AND HIGH HUMIDITY OPERATION	+60°C, 90%RH	96H
6	THERMAL SHOCK	-30°C → +80°C,	0.5H: 5CYCLES

9. LCD MODULES HANDLING PRECAUTIONS

- n** The display panel is made of glass. Do not subject it to a mechanical shock by dropping it from a high place, etc.
- n** If the display panel is damaged and the liquid crystal substance inside it leaks out, do not get any in your mouth. If the substance come into contact with your skin or clothes promptly wash it off using soap and water.
- n** Do not apply excessive force to the display surface or the adjoining areas since this may cause the color tone to vary.
- n** The polarizer covering the display surface of the LCD module is soft and easily scratched. Handle this polarize carefully.
- n** To prevent destruction of the elements by static electricity, be careful to maintain an optimum work environment.
 - Be sure to ground the body when handling the LCD module.
 - Tools required for assembly, such as soldering irons, must be properly grounded.
 - To reduce the amount of static electricity generated, do not conduct assembly and other work under dry conditions.
 - The LCD module is coated with a film to protect the display surface. Exercise care when peeling off this protective film since static electricity may be generated.
- n** Storage precautions
When storing the LCD modules, avoid exposure to direct sunlight or to the light of fluorescent lamps. Keep the modules in bags designed to prevent static electricity charging under low temperature / normal humidity conditions (avoid high temperature / high humidity and low temperatures below 0°C).Whenever possible, the LCD modules should be stored in the same conditions in which they were shipped from our company.

10. OTHERS

- n** Liquid crystals solidify at low temperature (below the storage temperature range) leading to defective orientation of liquid crystal or the generation of air bubbles (black or white). Air bubbles may also be generated if the module is subjected to a strong shock at a low temperature.
- n** If the LCD modules have been operating for a long time showing the same display patterns may remain on the screen as ghost images and a slight contrast irregularity may also appear. Abnormal operating status can be resumed to be normal condition by suspending use for some time. It should be noted that this phenomena does not adversely affect performance reliability.
- n** To minimize the performance degradation of the LCD modules resulting from caused by static electricity, etc. exercise care to avoid holding the following sections when handling the modules:
 - Exposed area of the printed circuit board
 - Terminal electrode sections.

X-ON Electronics

Largest Supplier of Electrical and Electronic Components

Click to view similar products for [TFT Displays & Accessories](#) category:

Click to view products by [Display Elektronik](#) manufacturer:

Other Similar products are found below :

[OAI-80038AA-2013-A](#) [HDA430T-3G1H](#) [NB-ATT01](#) [TCG104SVLQAPNN-AN20](#) [OAI-80038AA-2008-A](#) [315-U004B15300](#) [EIC-LCD-1080P](#) [NL10276BC20-18C](#) [DEM 128160D](#) [TMH-PW-N](#) [RFE43BU-AIW-DNG](#) [EA WF050-40S](#) [EA WF050-40ST](#) [RFC350X-AWW-DNG](#) [RFS390E-AWW-DNN](#) [DEM 480272G2](#) [VMX-PW-N \(A-TOUCH\)](#) [PH800480T013-ICA](#) [DEM 1024600N](#) [VMX-PW-N \(C-TOUCH\)](#) [DEM 1024600P](#) [VMH-PW-N \(C-TOUCH\)](#) [SM-RVT50HQHNWCA0](#) [DEM 240280A](#) [VMH-PW-N](#) [DEM 170320A](#) [VMH-PW-N](#) [PH240320T068-LAB08](#) [DEM 800480T1](#) [TMH-PW-N](#) [PH128128T041-LAA07](#) [PH480272T005-IAC02](#) [DEM 1024600P](#) [VMH-PW-N \(A-TOUCH\)](#) [DEM 800480T1](#) [TMH-PW-N \(C-TOUCH\)](#) [DEM 800480Q4](#) [VMX-PW-N](#) [DEM 800480T1](#) [TMH-PW-N \(A-TOUCH\)](#) [PH320240T-023-I02Q](#) [PH128800T004-ZZA01](#) [RFE430W-1YW-DBS](#) [DEM 1024600N](#) [VMX-PW-N \(A-TOUCH\)](#) [PH240320T074-ZAA01](#) [DEM 480480D](#) [VMX-PW-N \(C-TOUCH\)](#) [SM-RVT50HQSNWN00](#) [SM-RVT50HQHNWC00](#) [PH800480T033-ICB01](#) [RFE430W-AWW-DNN](#) [DEM 096096A](#) [VMH-PW-N](#) [RL0F00050000FGAAASA01](#) [SM-RVT50HQSNWCA0](#) [SM-RVT50HQSNWC00-B](#) [PH320240T028-ZEA01](#) [RFE430W-1YW-DBN](#) [SM-RVT50HQHNWC00-B](#) [DEM 120240A](#) [VMH-PW-N](#) [DEM 268800A](#) [VMH-PW-N](#) [RFF700B4-AIW-DNS](#) [DEM 800480O1](#) [VMH-PW-N](#)