

Display Elektronik GmbH

DATA SHEET

LCD MODULE

**DEM 320240T VMX-PW-N
(C-TOUCH)**

Product Specification

Version: 1

10.03.2020

GENERAL SPECIFICATION

MODULE NO. :

DEM 320240T VMX-PW-N(C-TOUCH)

CUSTOMER

VERSION NO.	CHANGE DESCRIPTION	DATE
0	ORIGINAL VERSION	06.03.2020
1	ADD LCD TYPE AND "UL NUMBER"	10.03.2020

PREPARED BY: YK

DATE: 10.03.2020

APPROVEDBY: MHI

DATE: 10.03.2020

CONTENTS

1. GENERAL SPECIFICATIONS 4

2. EXTERNAL DIMENSIONS..... 6

3. BLOCK DIAGRAM 8

4. PIN ASSIGNMENT 9

5. OPTICAL CHARACTERISTICS..... 10

6. ABSOLUTE MAXIMUM RATINGS 13

7. ELECTRICAL CHARACTERISTICS 13

8. RELIABILITY TEXT 18

9. LCD MODULES HANDLING PRECAUTIONS..... 19

10. OTHERS..... 19

1. GENERAL SPECIFICATIONS

ITEM	STANDARD VALUE	UNIT
LCD SIZE	3.5	INCH
LCD TYPE	TFT/IPS/NORMALLY BLACK/TRANSMISSIVE	-
MODULE SIZE	76.90 x 63.90 x 4.65	mm
ACTIVE AREA	70.08 x 52.56	mm
PIXEL PITCH	0.219 x 0.219	mm
NUMBER OF PIXELS	320 x 240	-
DRIVER IC	ST7272A	-
INTERFACE TYPE	24 BIT-RGB + SPI	-
TOP POLARIZER TYPE	Anti-glare	-
VIEWING DIRECTION	ALL	O'CLOCK
GRAY SCALE INVERSION DIRECTION	-	O'CLOCK
BACKLIGHT TYPE	6-DIES WHITE LED	-
TOUCH PANEL	CTP	-

TOUCH PANEL FEATURES

ITEM	CONTENS
Type	Capacitive Multi-touch
Module Size	76.90mm x 63.90mm x 4.65mm
View Area	71.08mm x 53.56mm
Interface	I2C
Operation Voltage	2.8V~3.3V
ITO Glass Thickness	0.4mm
Operation Humidity	20~90%RH
Storage Humidity	20~90%RH
Driver IC	FT5426
Resolution	320 x 240
Input Force	≤10g
Input Method	Finger or Exclusive Pen
Transparency	80%
Surface Hardness	>6H
Hitting Life	>35,000,000 times

2. EXTERNAL DIMENSIONS

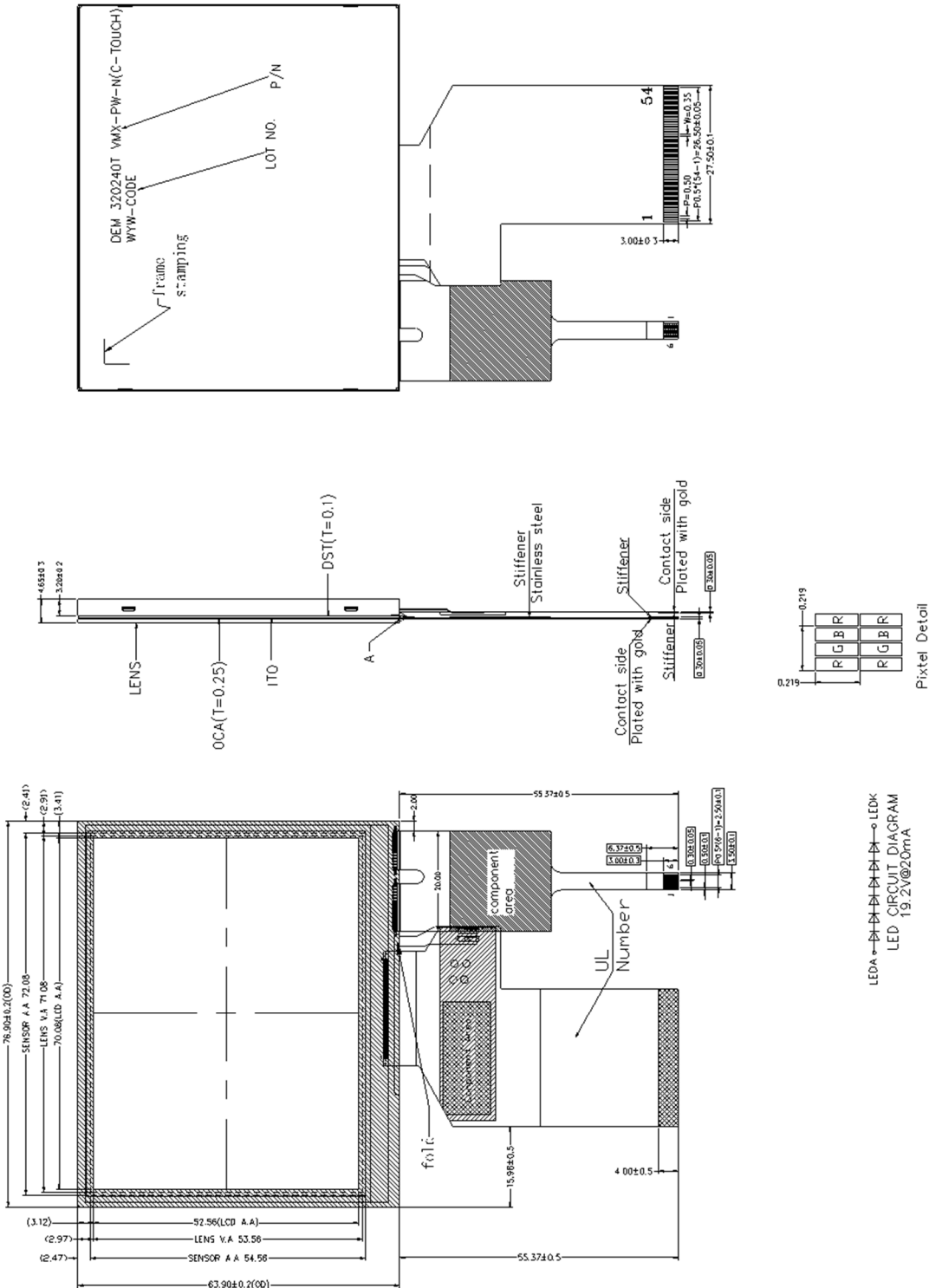

Remark:

- 1.Unmarked tolerance is ±0.3
- 2.All materials comply with RoHS

TOUCH PANEL DRAWING

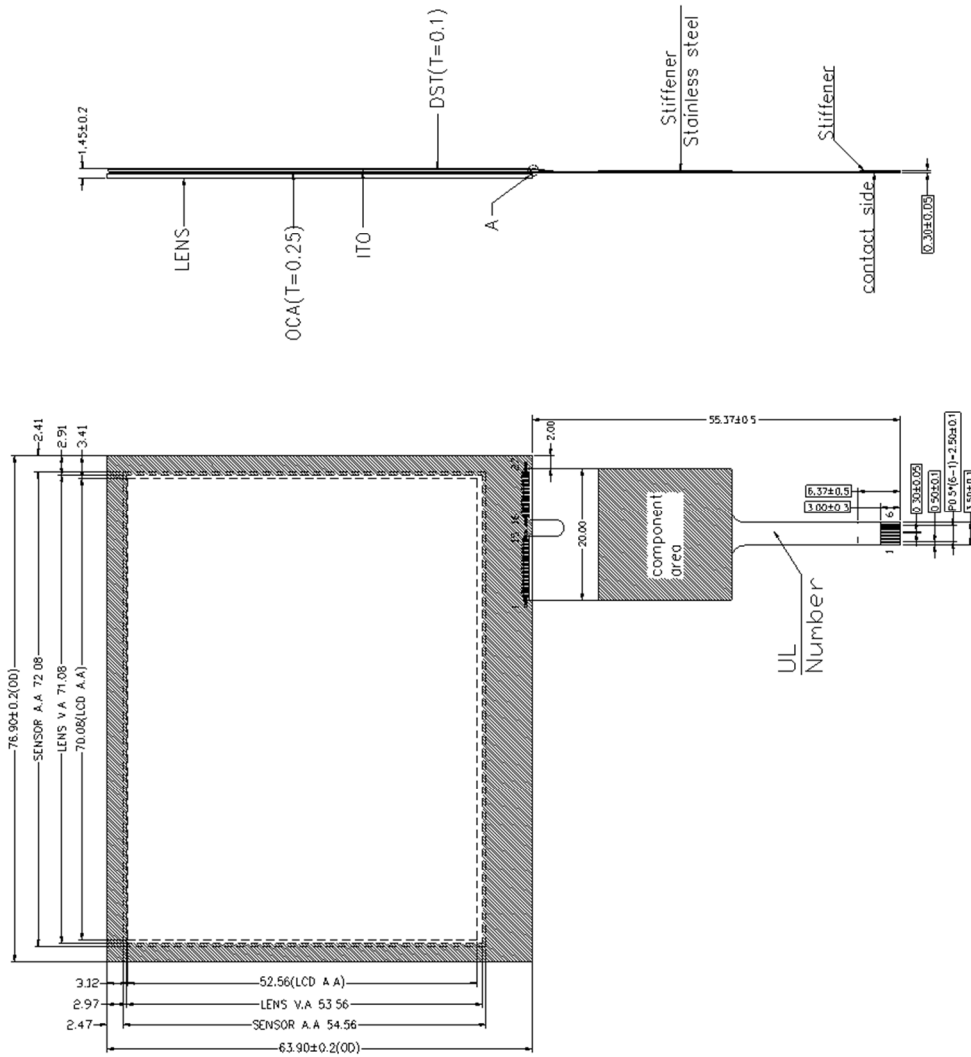

Remark:
 1. Unmarked tolerance is ±0.3
 2. All materials comply with RoHS
 3. □ ...: critical dimension.

3. BLOCK DIAGRAM

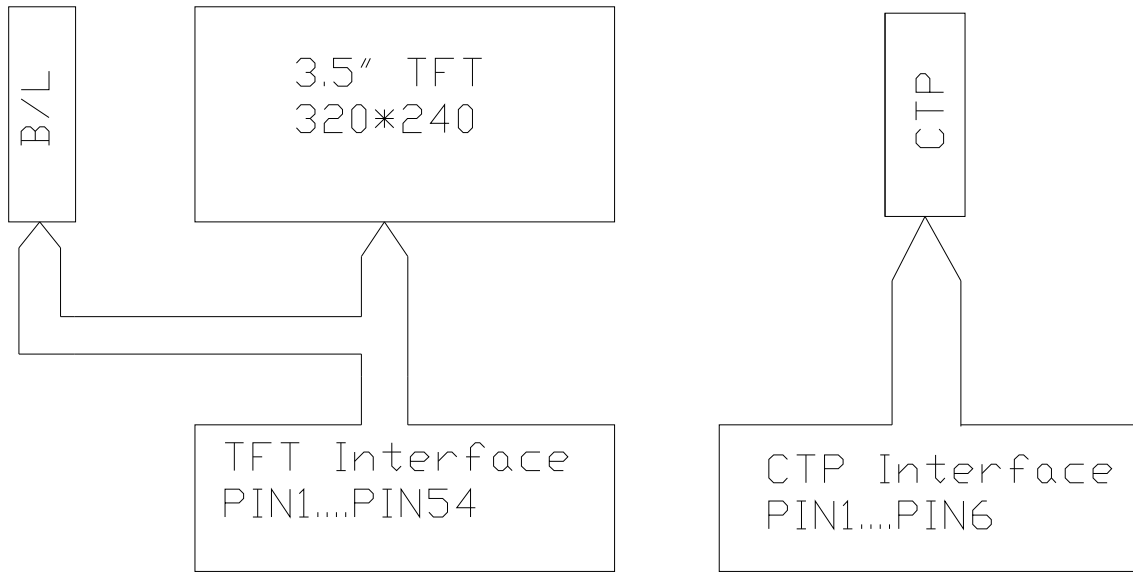

4. PIN ASSIGNMENT

Pin No.	Symbol	Description
1	LEDK	Cathode of LED
2	LEDK	Cathode of LED
3	LEDA	Anode of LED
4	LEDA	Anode of LED
5~7	NC	No Connect
8	RESET	Reset Pin
8	SPENA	Chip Select of Serial Interface
10	SPCLk	Clock Pin of Serial Interface
11	SPDAT	Data Input Pin of Serial Interface
12~19	B0~B7	Blue Data Bus
20~27	G0~G7	Green Data Bus
28~35	R0~R7	Red Data Bus
36	HSYNC	Horizontal Sync Signal, Negative Polarity
37	VSYNC	Vertical Sync Signal, Negative Polarity
38	DCLK	Clock Signal ,Latching Data at the Falling Edge
39	NC	No Connect
40	NC	No Connect
41	VDD	Power Supply
42	VDD	Power Supply
43~51	NC	No Connect
52	DEN	Display Enable Pin from Controller
53	GND	Power Ground
54	GND	Power Ground

Touch panel:

PIN NO.	SYMBOL	DESCRIPTION
1	INT	External Interrupt
2	GND	Negative Supply
3	/RST	Global Reset Input, Low Active
4	I2C_SDA	I2C Serial Data Input/Output
5	I2C_SCL	I2C Serial Clock Input/Output
6	AVDD	Positive Power Supply

5. OPTICAL CHARACTERISTICS

ITEM	SYMBOL	CONDITIONS	SPECIFICATIONS			UNIT	NOT
			MIN	TYP.	MAX		
Luminance	L	$I_L=20\text{mA}$	352	440	528	Cd/m ²	
Contrast Ratio	CR	$\theta =0^\circ$	640	800			
Response Time	T _{ON}	25°C		30	40	ms	
	T _{OFF}			30	40		
CIE COLOUR COORDINATE	RED	RX	VIEWING NORMAL ANGLE	0.60	0.62	0.64	
		RY		0.34	0.36	0.38	
	GREEN	GX		0.35	0.37	0.39	
		GY		0.57	0.59	0.61	
	BLUE	BX		0.12	0.14	0.16	
		BY		0.08	0.10	0.12	
	WHITE	WX		0.31	0.33	0.35	
		WY		0.35	0.37	0.39	
VIEWING ANGLE	Hor.	θ_{x+}	CR \geq 10	70	80	Degree	
		θ_{x-}		70	80		
	Ver.	θ_{y+}		70	80		
		θ_{y-}		70	80		
Uniformity	Un		80			%	

Note 1: Definition of Viewing Angle θ_x and θ_y :

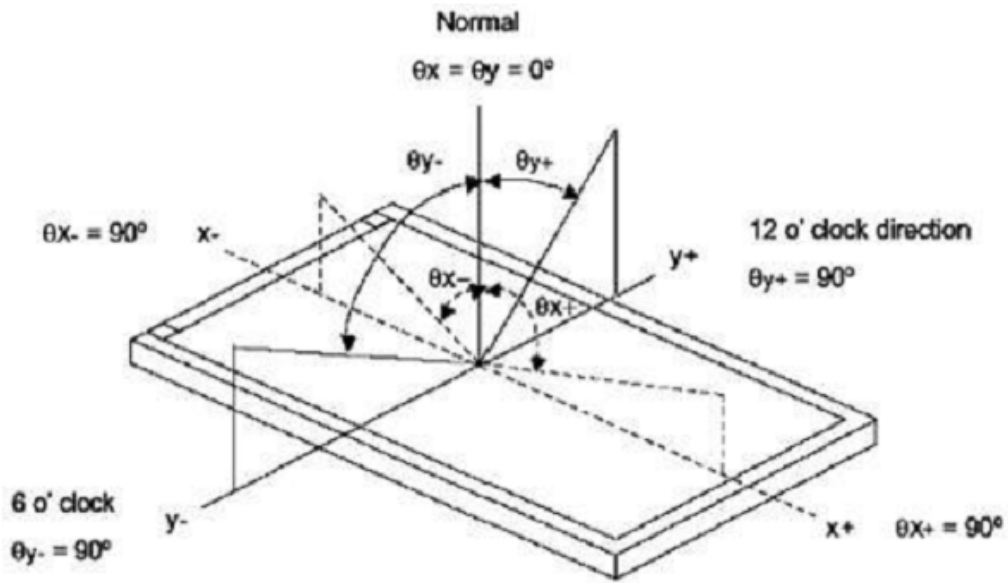

Note 2: Definition of contrast ratio CR:

$$CR = \frac{\text{Luminance of white state}}{\text{Luminance of black state}}$$

Note 3: Definition of Response Time (T_r, T_f)

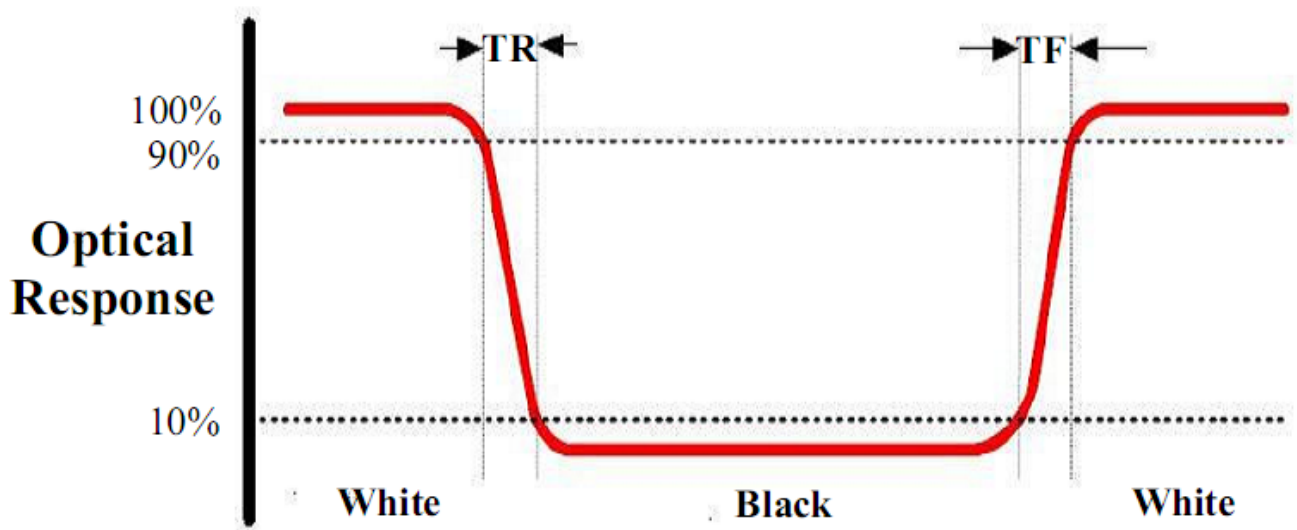

Note 4: Definition of Luminance

① The Brightness Test Equipment Setup

Field=2° (As measuring “black” image, field=2° is the best testing condition)

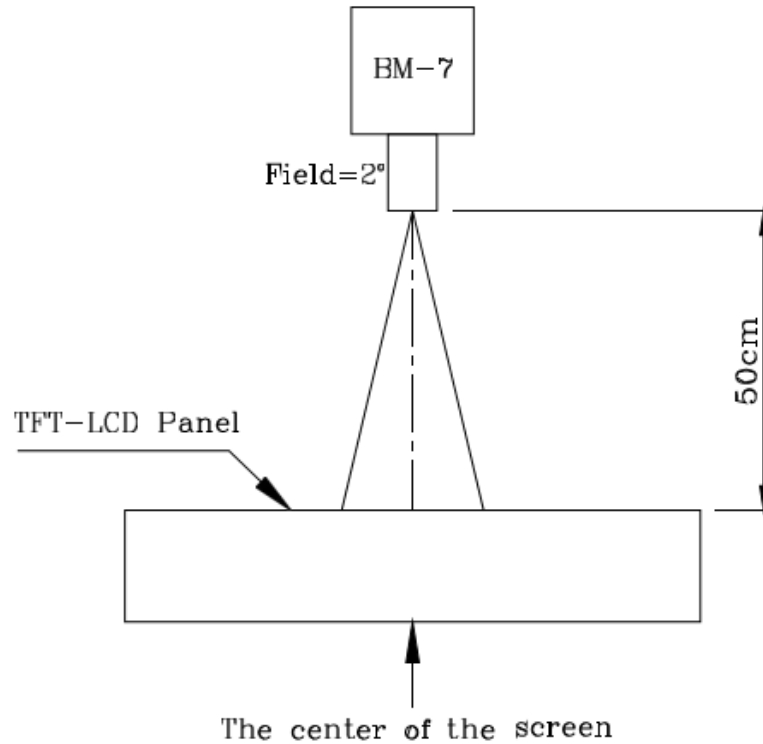

② The Brightness Test Point Setup

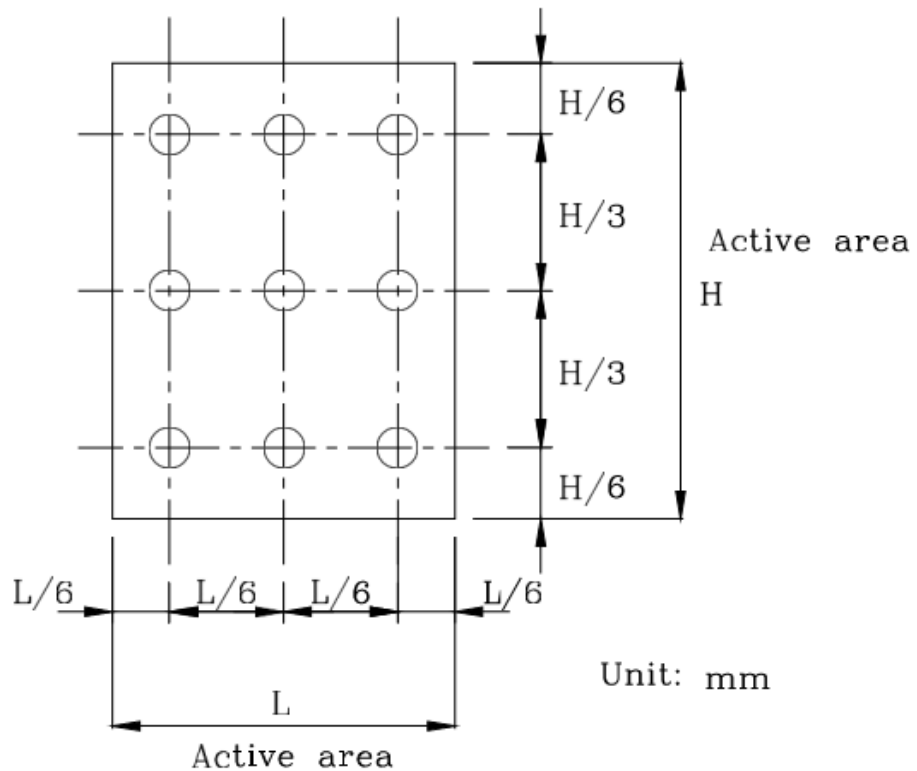

6. ABSOLUTE MAXIMUM RATINGS

PARAMETER	SYMBOL	MIN	MAX	UNIT
Power Supply Voltage	VDD	-0.3	4.5	V
Supply voltage for Logic	VDD	-0.3	4.5	V
Supply Current (One LED)	I _{LED}		30	mA
Operating Temperature	Top	-30	+85	°C
Storage Temperature	Tst	-30	+85	°C

7. ELECTRICAL CHARACTERISTICS

7.1 Input power

ITEM	SYMBOL	Min	TYP	MAX	UNIT
Supply Voltage for Analog	VDD	3.0	3.3	3.6	V
Supply Voltage for Logic	VDD	3.0	3.3	3.6	V
Input Voltage	V _{IL}	GND	-	0.3VDD	
	V _{IH}	0.7VDD	-	VDD	
Input Leakage Current	I _{LKG}	-1		1	μA

7.2 Backlight Driving Conditions

ITEM	SYMBOL	SPECIFICATIONS			UNIT	Remark
		MIN	TYP.	MAX		
Voltage for LED Backlight	V _f	16.8	18.6	20.4	V	IL=20mA
Current for LED Backlight	I _L		20		mA	
Power Consumption	P		0.375		W	
LED Lifetime		30000	50000		H _r	

7.3 TIMING CHARACTERISTICS

7.3.1 SYNC MODE

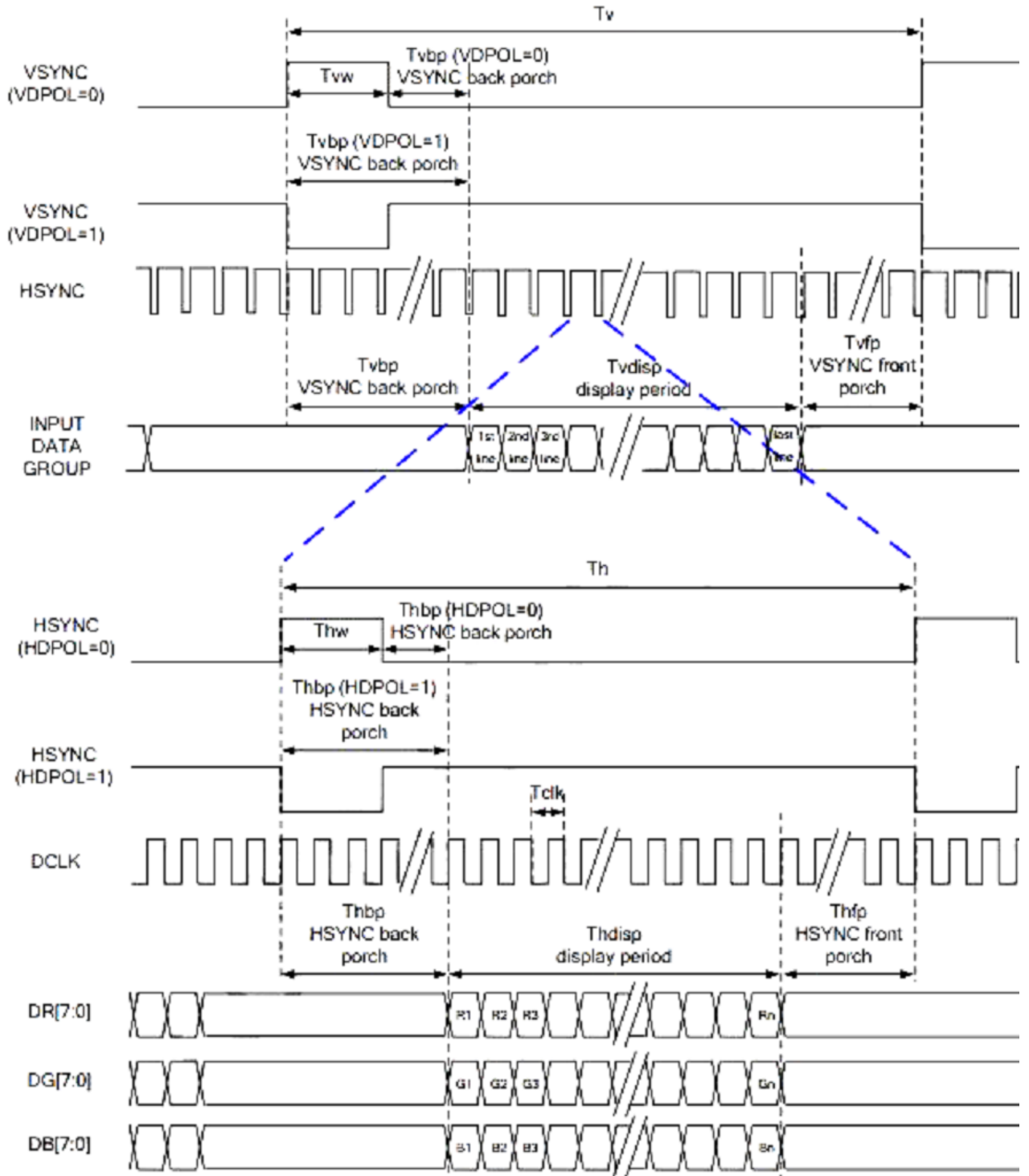

7.3.2 SYNC DE-MODE

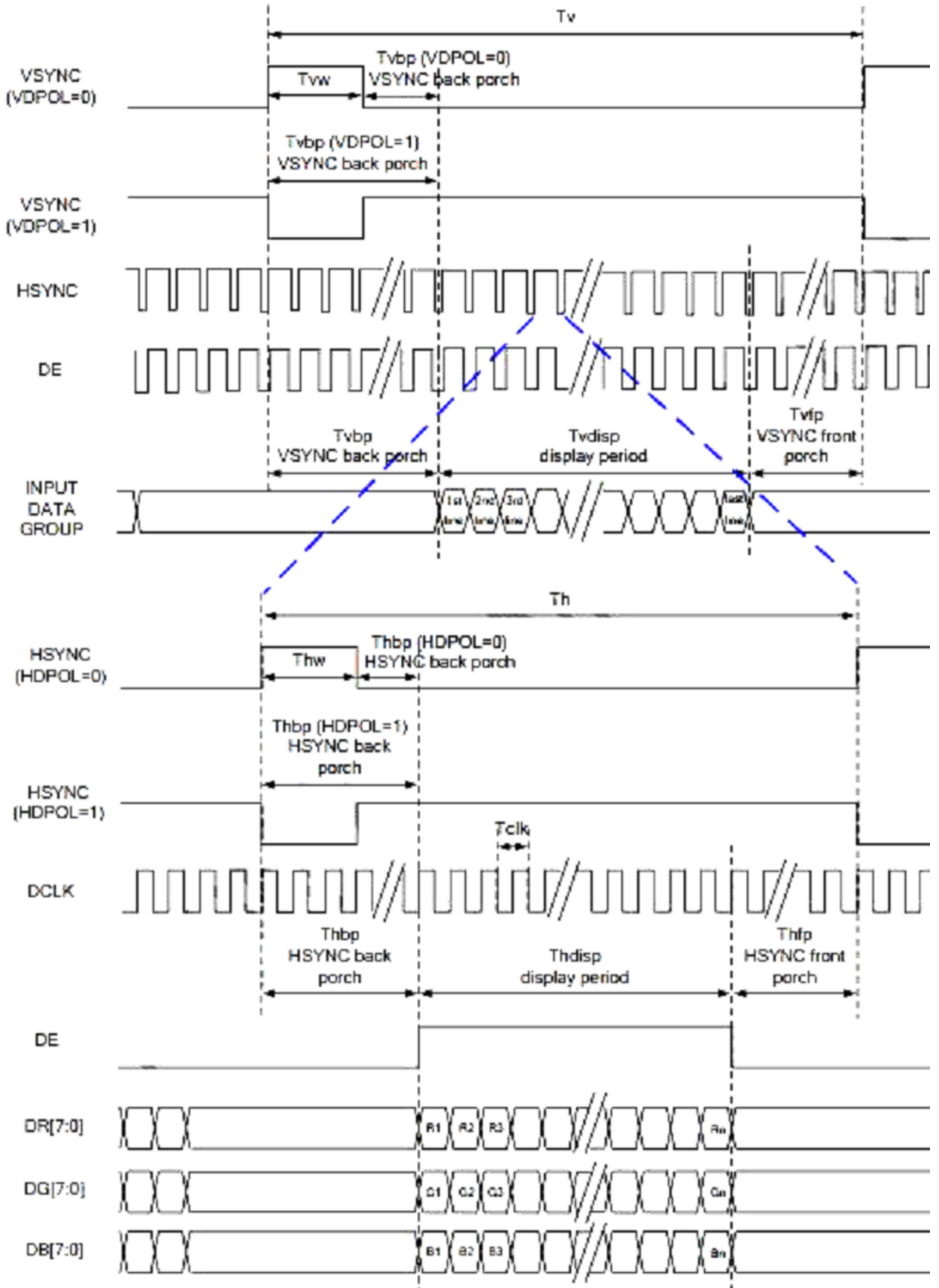

7.3.3 DE MODE

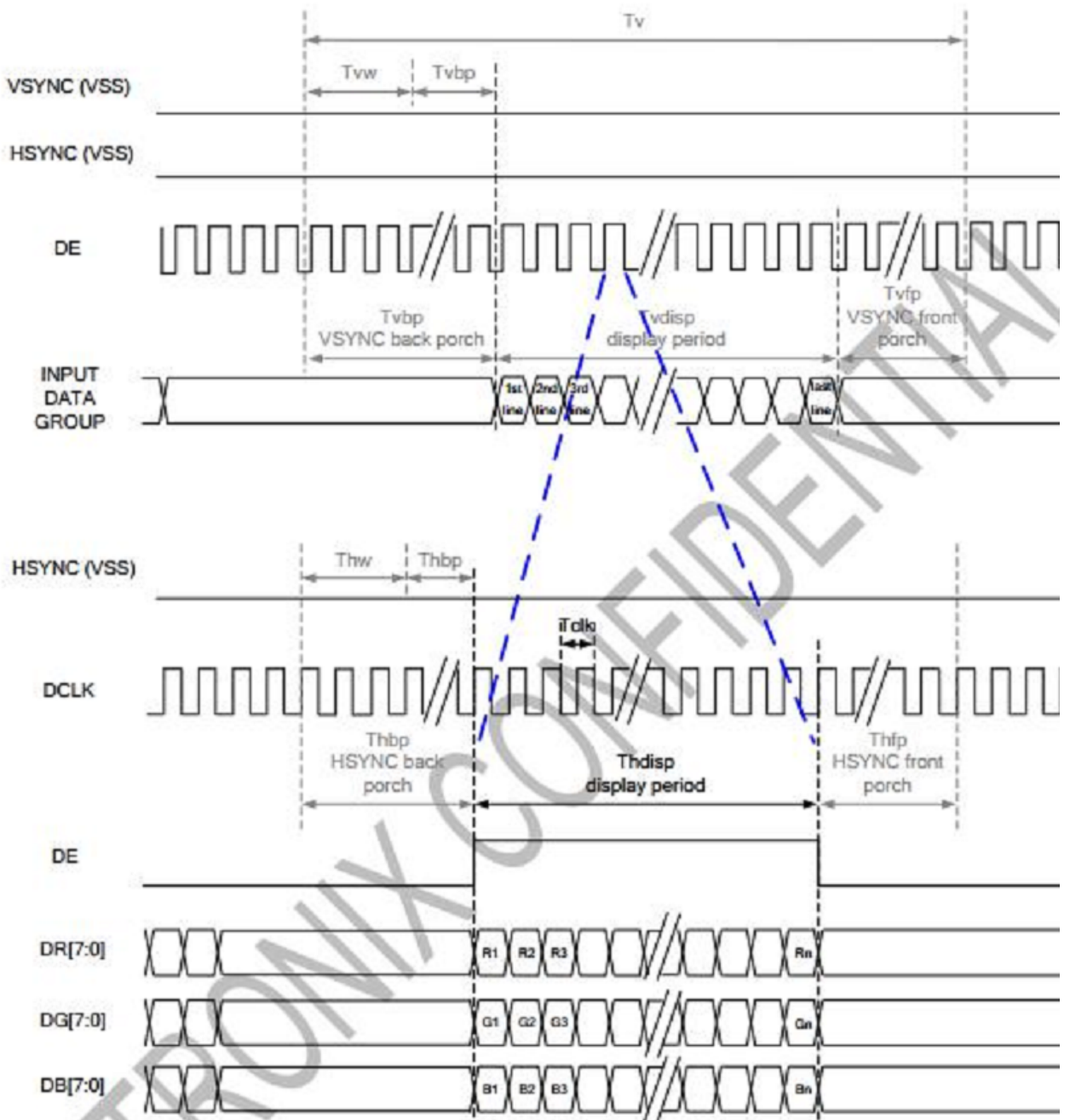

RGB Mode Selection Table	DCLK	HSYNC	VSYNC	DE
SYNC - DE Mode	Input	Input	Input	Inp
SYNC Mode	Input	Input	Input	GN
DE Mode	Input	GND	GND	Inp

Note: "Input" means these signals are driven by host side.

7.3.4 Parallel 24 bit RGB Timing Table

Parallel 24-bit RGB Input Timing (PVDD=VDD=VDDI= 3.3V, AGND= 0V, TA=25°C)

Parallel 24-bit RGB Input Timing Table							
Item	Symbol	Min.	Typ.	Max.	Unit	Remark	
DCLK Frequency	Fclk	5	6	8	MHz		
DCLK Period	Tclk	125	167	200	ns		
HSYNC	Period Time	Th	325	371	438	DCLK	
	Display Period	Thdisp		320		DCLK	
	Back Porch	Thbp	3	43	43	DCLK	By H_BLANKING setting
	Front Porch	Thfp	2	8	75	DCLK	
	Pulse Width	Thw	2	4	43	DCLK	
VSYNC	Period Time	Tv	244	260	289	HSYNC	
	Display Period	Tvdisp		240		HSYNC	
	Back Porch	Tvbp	2	12	12	HSYNC	By V_BLANKING setting
	Front Porch	Tvfp	2	8	37	HSYNC	
	Pulse Width	Tvw	2	4	12	HSYNC	

Note: It is necessary to keep Tvbp =12 and Thbp =43 in sync mode. DE mode is unnecessary to keep it.

8. RELIABILITY TEXT**8.1 Standard Specification for Reliability of LCD Module**

NO.	TEST ITEM	CONDITIONS
1	HIGH TEMPERATURE STORAGE	TA=+85°C 240Hr
2	LOW TEMPERATURE STORAGE	TA=-30°C 240Hr
3	HIGH TEMPERATURE OPERATION	TA=+85°C 240Hr
4	LOW TEMPERATURE OPERATION	TA=-30°C 240Hr
5	MOISTURE STORAGE	+60°C, 90%RH, MAX OF 240H
6	THERMAL SHOCK STORAGE	-30°C for 30 minutes → normal temperature for 5 minutes → +85°C for 30 minutes → normal temperature for 5 minutes.as one cycle
7	PACKING VIBRATION	Frequency range:10Hz ~55Hz Amplitude of vibration: 1.5mm Sweep time: 12,min,X,Y,Z 2hours for each direction
8	ESD	Air:±8kV 150Pf/300Ω 5 times
		Contact:±4kV 150Pf/300Ω 5 times

9. LCD MODULES HANDLING PRECAUTIONS

- n** The display panel is made of glass. Do not subject it to a mechanical shock by dropping it from a high place, etc.
- n** If the display panel is damaged and the liquid crystal substance inside it leaks out, do not get any in your mouth. If
- n** The substance come into contact with your skin or clothes promptly wash it off using soap and water.
- n** Do not apply excessive force to the display surface or the adjoining areas since this may cause the color tone to vary.
- n** The polarizer covering the display surface of the LCD module is soft and easily scratched. Handle this polarize carefully.
- n** To prevent destruction of the elements by static electricity, be careful to maintain an optimum work environment.
 - Be sure to ground the body when handling the LCD module.
 - Tools required for assembly, such as soldering irons, must be properly grounded.
 - To reduce the amount of static electricity generated, do not conduct assembly and other work under dry conditions.
 - The LCD module is coated with a film to protect the display surface. Exercise care when peeling off this protective film since static electricity may be generated.
- n** Storage precautions
When storing the LCD modules, avoid exposure to direct sunlight or to the light of fluorescent lamps. Keep the modules in bags designed to prevent static electricity charging under low temperature / normal humidity conditions (avoid high temperature / high humidity and low temperatures below 0 °C). Whenever possible, the LCD modules should be stored in the same conditions in which they were shipped from our company.

10. OTHERS

- n** Liquid crystals solidify at low temperature (below the storage temperature range) leading to defective orientation of liquid crystal or the generation of air bubbles (black or white). Air bubbles may also be generated if the module is subjected to a strong shock at a low temperature.
- n** If the LCD modules have been operating for a long time showing the same display patterns may remain on the screen as ghost images and a slight contrast irregularity may also appear. Abnormal operating status can be resumed to be normal condition by suspending use for some time. It should be noted that this phenomena does not adversely affect performance reliability.
- n** To minimize the performance degradation of the LCD modules resulting from caused by static electricity, etc. exercise care to avoid holding the following sections when handling the modules:
 - Exposed area of the printed circuit board
 - Terminal electrode sections.

X-ON Electronics

Largest Supplier of Electrical and Electronic Components

Click to view similar products for [TFT Displays & Accessories](#) category:

Click to view products by [Display Elektronik](#) manufacturer:

Other Similar products are found below :

[OAI-80038AA-2013-A](#) [HDA430T-3G1H](#) [NB-ATT01](#) [TCG104SVLQAPNN-AN20](#) [OAI-80038AA-2008-A](#) [315-U004B15300](#) [EIC-LCD-1080P](#) [NL10276BC20-18C](#) [DEM 128160D](#) [TMH-PW-N](#) [RFE43BU-AIW-DNG](#) [EA WF050-40S](#) [EA WF050-40ST](#) [RFC350X-AWW-DNG](#) [RFS390E-AWW-DNN](#) [DEM 480272G2](#) [VMX-PW-N \(A-TOUCH\)](#) [PH800480T013-ICA](#) [DEM 1024600N](#) [VMX-PW-N \(C-TOUCH\)](#) [DEM 1024600P](#) [VMH-PW-N \(C-TOUCH\)](#) [SM-RVT50HQHNWCA0](#) [DEM 240280A](#) [VMH-PW-N](#) [DEM 170320A](#) [VMH-PW-N](#) [PH240320T068-LAB08](#) [DEM 800480T1](#) [TMH-PW-N](#) [PH128128T041-LAA07](#) [PH480272T005-IAC02](#) [DEM 1024600P](#) [VMH-PW-N \(A-TOUCH\)](#) [DEM 800480T1](#) [TMH-PW-N \(C-TOUCH\)](#) [DEM 800480Q4](#) [VMX-PW-N](#) [DEM 800480T1](#) [TMH-PW-N \(A-TOUCH\)](#) [PH320240T-023-I02Q](#) [PH128800T004-ZZA01](#) [RFE430W-1YW-DBS](#) [DEM 1024600N](#) [VMX-PW-N \(A-TOUCH\)](#) [PH240320T074-ZAA01](#) [DEM 480480D](#) [VMX-PW-N \(C-TOUCH\)](#) [SM-RVT50HQSNWN00](#) [SM-RVT50HQHNWC00](#) [PH800480T033-ICB01](#) [RFE430W-AWW-DNN](#) [DEM 096096A](#) [VMH-PW-N](#) [RL0F00050000FGAAASA01](#) [SM-RVT50HQSNWCA0](#) [SM-RVT50HQSNWC00-B](#) [PH320240T028-ZEA01](#) [RFE430W-1YW-DBN](#) [SM-RVT50HQHNWC00-B](#) [DEM 120240A](#) [VMH-PW-N](#) [DEM 268800A](#) [VMH-PW-N](#) [RFF700B4-AIW-DNS](#) [DEM 800480O1](#) [VMH-PW-N](#)