



# **TFT LCD Module**

## **Product Specification**

### **DT070CTFT-PTS1**

**7.0" (800(RGB) x 480 DOTS) TFT Module  
with Capacitive Touch Panel**

February 8, 2018

**Remark:**

Contents in this document are subject to change without notice. No part of this document may be reproduced or transmitted in any form or by any means, electronic or mechanical, for any purpose, without the express written permission of Displaytech Ltd.

**Displaytech Ltd.**

Tel: (852) 2311 2080 ; Fax: (852) 2722 6998 ; Email: [sales@displaytech.com.hk](mailto:sales@displaytech.com.hk)

Address: 31E Billion Plaza 2, No. 10 Cheung Yue Street, Cheung Sha Wan, Kowloon,  
Hong Kong.

Website: <http://www.displaytech.com.hk>

**Revision Record**

<b>REV</b>	<b>CHANGES</b>	<b>DATE</b>
1.0 (Ref. 1.0 20180202)	First release	Feb 8, 2018

## Table of Content

<b>Revision Record .....</b>	<b>1</b>
<b>1. Scope .....</b>	<b>3</b>
<b>2. Application .....</b>	<b>3</b>
<b>3. General Information.....</b>	<b>3</b>
<b>4. Outline Drawing .....</b>	<b>4</b>
<b>5. Interface Signals .....</b>	<b>5</b>
5.1 Interface Signal for display .....	5
5.2 Touch Screen Interface Signals .....	6
<b>6. Absolute Maximum Ratings.....</b>	<b>6</b>
6.1 Electrical absolute maximum ratings .....	6
6.2 Environment conditions.....	7
<b>7. Electrical Specifications .....</b>	<b>7</b>
7.1 Electrical characteristics .....	7
7.2 Current consumption .....	7
7.3 LED backlight.....	7
<b>8. Command / AC Timing .....</b>	<b>8</b>
8.1 AC Electrical Characteristics.....	8
8.2 Input Clock and Data Timing Diagram.....	8
8.3 Timing .....	8
8.4 Data Input Format.....	9
8.5 Power ON/OFF Sequence .....	9
<b>9. Optical Specification .....</b>	<b>10</b>
<b>10. Environmental / Reliability Tests.....</b>	<b>12</b>
<b>11. Precautions for Use of LCD Modules.....</b>	<b>13</b>
11.1 Safety .....	13
11.2 Handling .....	13
11.3 Static electricity .....	13
11.4 Storage .....	13
11.5 Cleaning.....	13
11.6 Cautions for installing and assembling.....	13

## 1. Scope

This data sheet is to introduce the specification of DT070CTFT-PTS1, active matrix TFT module. It is composed of a color TFT-LCD panel, driver ICs, FPC, capacitive touch panel and backlight unit. The 7.0" display area contains 800(RGB) x 480 pixels.

## 2. Application

Digital equipment which need color display, mobile navigator/video systems.

## 3. General Information

Item	Contents	Unit
Size	7.0	inch
Resolution	800(RGB) x 480	/
Interface	RGB 24-bit	/
Technology Type	a-Si TFT	/
Pixel Pitch	0.1926 x 0.1790	mm
Pixel Configuration	R.G.B. Stripe	
Outline Dimension (W x H x D)	165.0 x 100.0 x 7.45	mm
Active Area	154.08 x 85.92	mm
Display Mode	Transmissive, Normally White	/
Viewing Direction	12	O'clock
Backlight Type	LED	/
TFT Controller/ Driver IC	HX8264E & HX8664B	/
Capacitive Touch Panel Driver IC	FT5426	/

### 4. Outline Drawing

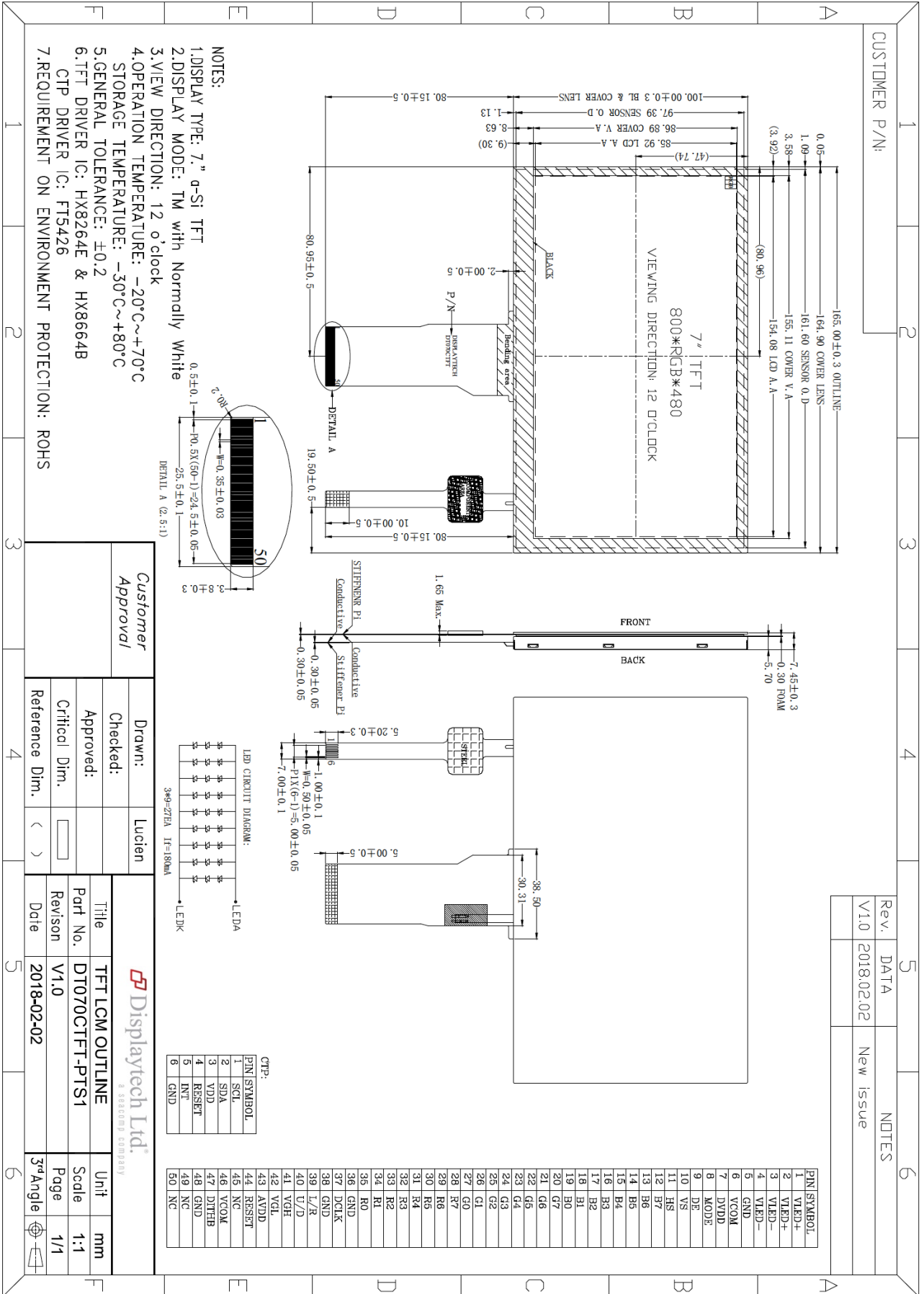

## 5. Interface Signals

### 5.1 Interface Signal for display

No	Symbol	Description	Remark
1	VLED+	Power for LED backlight (Anode)	
2	VLED+	Power for LED backlight (Anode)	
3	VLED-	Power for LED backlight (Cathode)	
4	VLED-	Power for LED backlight (Cathode)	
5	GND	Power Ground	
6	VCOM	Common voltage	
7	DVDD	Power for digital circuit	
8	MODE	DE/SYNC mode select	Note 1
9	DE	Data input enable	
10	VS	Vertical sync input	
11	HS	Horizontal sync input	
12	B7	Blue data (MSB)	Note 2
13	B6	Blue data	
14	B5	Blue data	
15	B4	Blue data	
16	B3	Blue data	
17	B2	Blue data	
18	B1	Blue data	
19	B0	Blue data (LSB)	Note 2
20	G7	Green data (MSB)	Note 2
21	G6	Green data	
22	G5	Green data	
23	G4	Green data	
24	G3	Green data	
25	G2	Green data	
26	G1	Green data	
27	G0	Green data (LSB)	Note 2
28	R7	Red data (MSB)	Note 2
29	R6	Red data	
30	R5	Red data	
31	R4	Red data	
32	R3	Red data	
33	R2	Red data	
34	R1	Red data	
35	B0	Red data (LSB)	Note 2
36	GND	Power Ground	
37	DCLK	Sample clock	Note 3
38	GND	Power Ground	
39	L/R	Left / Right selection	Note 4, 5
40	U/D	Up / Down selection	Note 4, 5
41	VGH	Gate ON Voltage	
42	VGL	Gate OFF Voltage	
43	AVDD	Power for analog circuits	
44	RESET	Global reset pin	Note 6
45	NC	No connection	
46	VCOM	Common voltage	
47	DITHB	Dithering function	Note 7
48	GND	Power Ground	
49	NC	No connection	
50	NC	No connection	

The recommended connector: Hirose FH19SC-50S-0.5SH, FH12S-50S-0.5SH; or Molex 0512965093, 0512965094; or equivalent

Note 1: DE/SYNC mode select. Normally pull high.

When select DE mode, MODE="1", VS and HS must pull high.

When select SYNC mode, MODE="0", DE must be grounded.

Note 2: When input 18 bits RGB data, the two low bits of R, G and B data must be grounded.

Note 3: Data shall be latched at the falling edge of DCLK.

Note 4: Selection of scanning mode

Setting of scan control input		Scanning direction
U/P	L/R	
GND	DVDD	Up to down, left to right
DVDD	GND	Down to up, right to left
GND	GND	Up to down, right to left
DVDD	DVDD	Down to up, left to right

Note 5: Definition of scanning direction.

Refer to the figure as below:

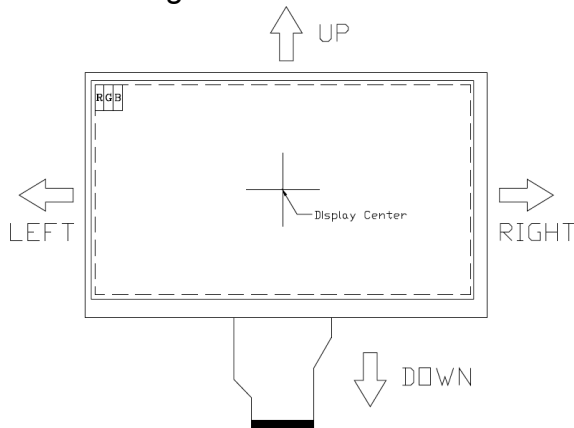

Note 6: Global reset pin. Active low to enter reset state. Suggest to connect with an RC reset circuit for stability. Normally pull high.

Note 7: Dithering function enable control, normally pull high.

When DITHB="1", Disable internal dithering function,

When DITHB="0", Enable internal dithering function,

### 5.2 Touch Screen Interface Signals

No	Symbol	Description
1	SCL	I <sup>2</sup> C clock signal
2	SDA	I <sup>2</sup> C data signal
3	VDD	Power supply
4	RESET	Reset pin
5	INT	Interrupt output pin
6	GND	Power ground

## 6. Absolute Maximum Ratings

### 6.1 Electrical absolute maximum ratings

Parameter	Symbol	MIN	MAX	Unit	Remark
Power Voltage	VCC	-0.5	+5.0	V	
	AVDD	-0.5	13.5	V	
	VGH	-0.3	+42	V	
	VGL	VGH-42	+0.3	V	

## 6.2 Environment conditions

Parameter	Symbol	MIN	MAX	Unit	Remark
Operating Temperature	TOPR	-20	+70	°C	
Storage Temperature	TSTG	-30	+80	°C	

Notes:

- When temperature is below 0°C, the response time of liquid crystal (LC) will be slower and the color of panel will be darker.
- If module driving condition exceeds the absolute maximum ratings, permanent damaged may be resulted. If module is driven within the absolute maximum ratings but exceeded the DC characteristics, mal-function may be resulted.
- VDD/VCC > VSS.

## 7. Electrical Specifications

### 7.1 Electrical characteristics

GND=0V, Ta=25°C

Item	Symbol	MIN	TYP	MAX	Unit	
Digital supply voltage	VCC	-	3.3	-	V	
Analog supply voltage	AVDD	-	10.4	-	V	
Gate ON voltage	VGH	-	16	-	V	
Gate OFF voltage	VGL	-	-7	-	V	
Common electrode driving signal	VCOM	3.5	-	4.5	V	
Logic supply voltage	DVDD	2.8	3.3	3.6	V	
Input signal voltage	Low level	VIL	0	-	0.3xDVDD	V
	High level	VIH	0.7xDVDD	-	DVDD	V
Output signal voltage	Low level	VOL	-	-	GND+0.4	V
	High level	VOH	DVDD-0.4	-	-	V

### 7.2 Current consumption

Item	Symbol	MIN	TYP	MAX	Unit	Remark
Digital supply current	IDVDD	-	3.22	8.70	mA	DVDD=3.3V
Analog supply current	IAVDD	-	15.69	23.01	mA	AVDD=10.4V
Gate ON current	IVGH	-	0.20	0.22	mA	VGH=16.0V
Gate OFF current	IVGL	-	0.20	0.22	mA	VGL=-7.0V
Power consumption	Panel & Gamma	-	177.67	254.65	mW	-
	Backlight	-	1.152	1.267	W	-
	Total	-	1.330	1.522	W	-

### 7.3 LED backlight

Ta=25°C

Item	Symbol	MIN	TYP	MAX	Unit	Remark
Forward current	IL	-	180	-	mA	
Forward voltage	VL	-	9.6	-	V	



## 8. Command / AC Timing

### 8.1 AC Electrical Characteristics

Item	Symbol	Rating			Unit	Remark
		MIN	TYP	MAX		
HS setup time	Thst	8	-	-	ns	
HS hold time	Thhd	8	-	-	ns	
VS setup time	Tvst	8	-	-	ns	
VS hold time	Tvhd	8	-	-	ns	
Data setup time	Tdsu	8	-	-	ns	
Data hold time	Tdhd	8	-	-	ns	
DE setup time	Tesu	8	-	-	ns	
DE hold time	Tehd	8	-	-	ns	
DVDD power on slew rate	TPOR	-	-	20	ms	From 0 to 90% DVDD
RESET pulse width	TRst	1	-	-	ms	
DCLK cycle time	Tcoh	20	-	-	ns	
DCLK pulse duty	Tcwh	40	50	60	%	

### 8.2 Input Clock and Data Timing Diagram

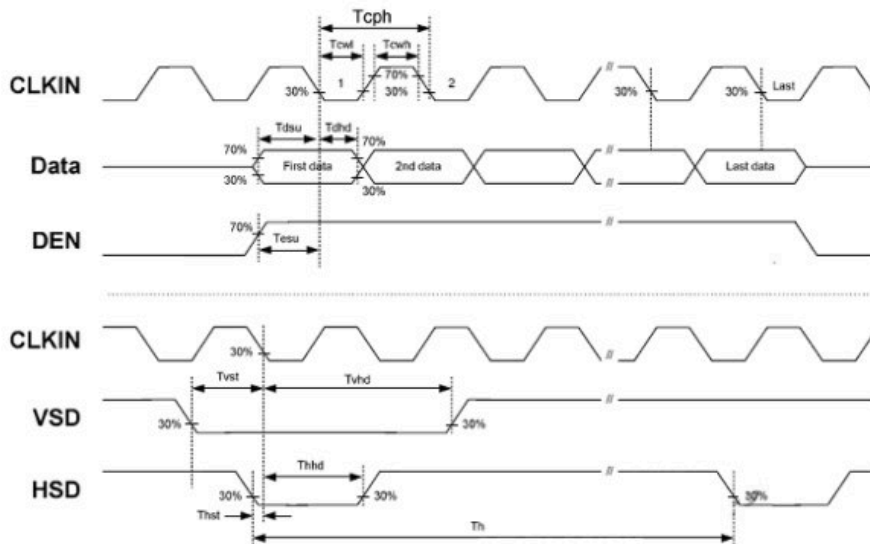

### 8.3 Timing

Item	Symbol	Rating			Unit	Remark
		MIN	TYP	MAX		
Horizontal display area	Thd	-	800	-	DCLK	
DCLK frequency	Fclk	26.4	33.3	46.8	MHz	
One horizontal line	Th	862	1056	1200	DCLK	
HS pulse width	Thpw	1	-	40	DCLK	
HS blanking	thb	46	46	46	DCLK	
HS front porch	thfp	16	210	354	DCLK	

Item	Symbol	Rating			Unit	Remark
		MIN	TYP	MAX		
Vertical display area	Tvd	-	480	-	TH	
VS period time	Tv	510	525	650	TH	
VS pulse width	Tvpw	1	-	20	TH	
VS blanking	tvb	23	23	23	TH	
VS front porch	tvfp	7	22	14	TH	

### 8.4 Data Input Format

#### 8.4.1 Horizontal input timing diagram



#### 8.4.2 Vertical input timing diagram

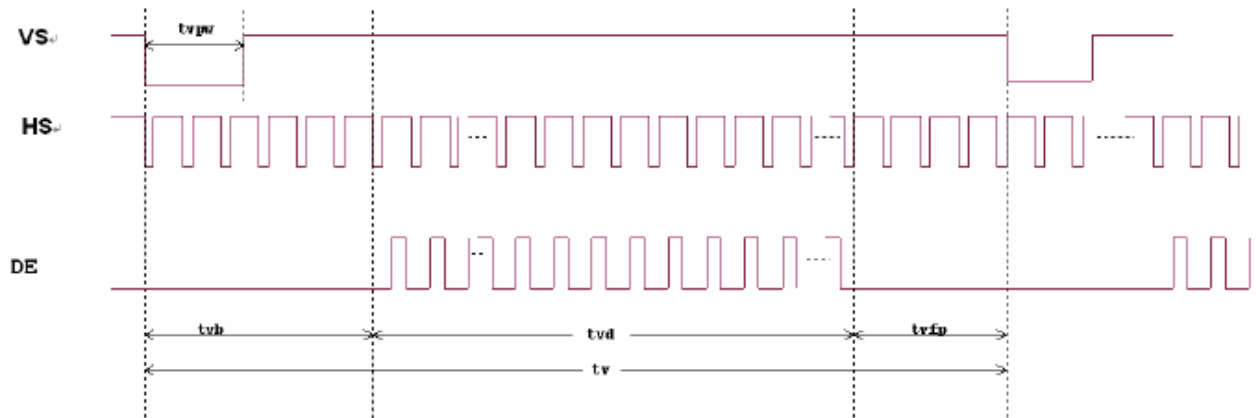

### 8.5 Power ON/OFF Sequence

#### a. Power on

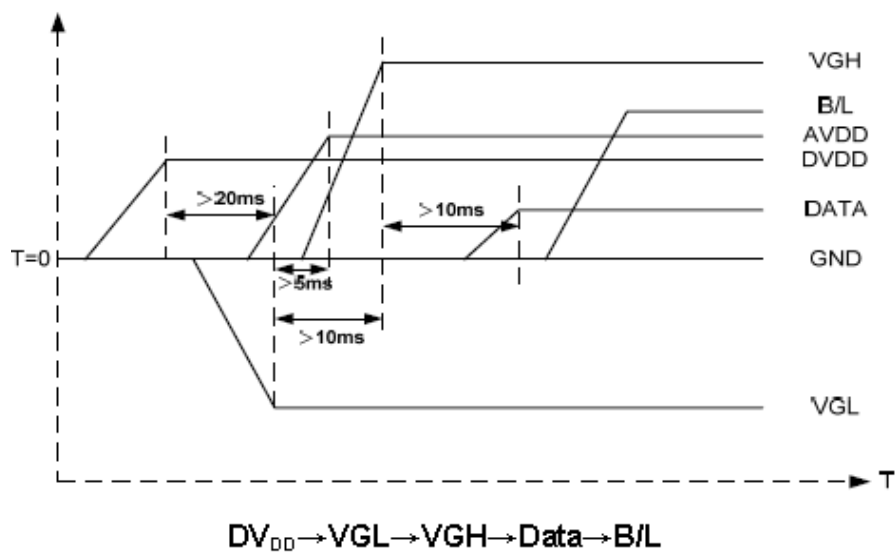

b. Power off

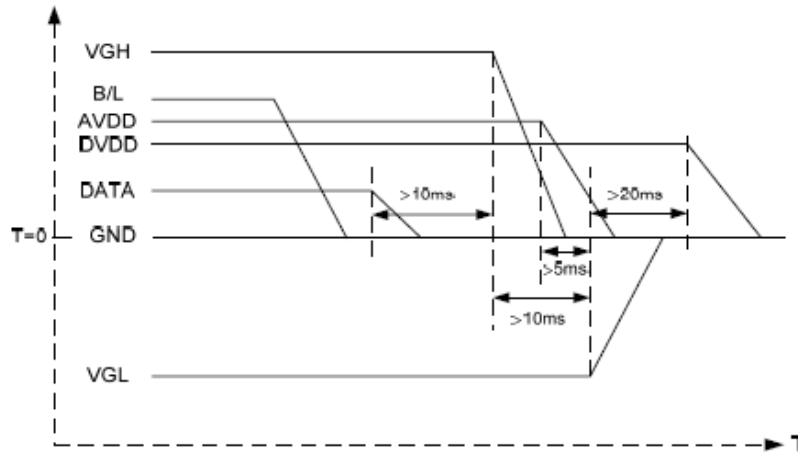

B/L → Data → VGH → VGL → DV<sub>DD</sub>

Note: Data include R0~R7, B0~B7, G0~G7, U/D, L/R, DCLK, HS, VS, DE.

### 9. Optical Specification

Ta=25°C

Item	Symbol	Condition	MIN	TYP	MAX	Unit	Remark
Contrast ratio	CR	$\theta=0^\circ$	400	500	-		Note 1, 2
Response time	Ton	25°C	-	10	20	ms	Note 1, 3
	Toff		-	15	30		
View angles	$\theta T$	CR $\geq 10$	60	70	-	Degree	Note 4
	$\theta B$		50	60	-		
	$\theta L$		60	70	-		
	$\theta R$		60	70	-		
Chromaticity	White	x	0.267	0.317	0.367		Note 1, 5
		y	0.284	0.334	0.384		
	Red	x	0.567	0.617	0.667		
		y	0.305	0.355	0.405		
	Green	x	0.289	0.339	0.389		
		y	0.483	0.533	0.583		
	Blue	x	0.092	0.142	0.192		
		y	0.049	0.099	0.149		
Luminance	L		-	420	-	cd/m <sup>2</sup>	Note 1, 6
NTSC Ratio	S		-	50	-	%	
Uniformity	U		-	75	-	%	Note 1, 7

Test condition: DVDD=3.3V, the ambient temperature is 25°C

Note 1: Definition of optical measurement system.

Temperature = 25°C(±3°C)

LED back-light: ON, Environment brightness < 150 lx

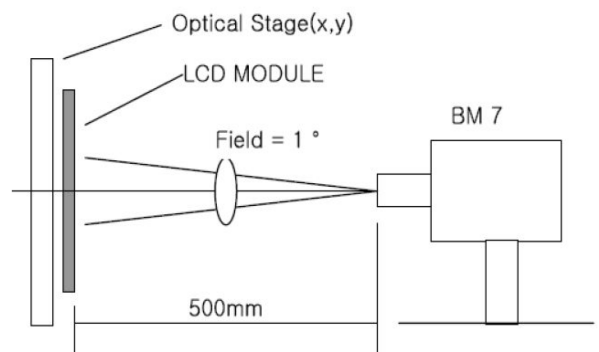

Note 2: Contrast ratio is defined as follow:

$$\text{Contrast Ratio} = \frac{\text{Surface Luminance with all white pixels}}{\text{Surface Luminance with all black pixels}}$$

Note 3: Response time is defined as follow:

Response time is the time required for the display to transition from black to white (Rise time,  $T_r$ ) and from white to black (Decay Time,  $T_f$ ).

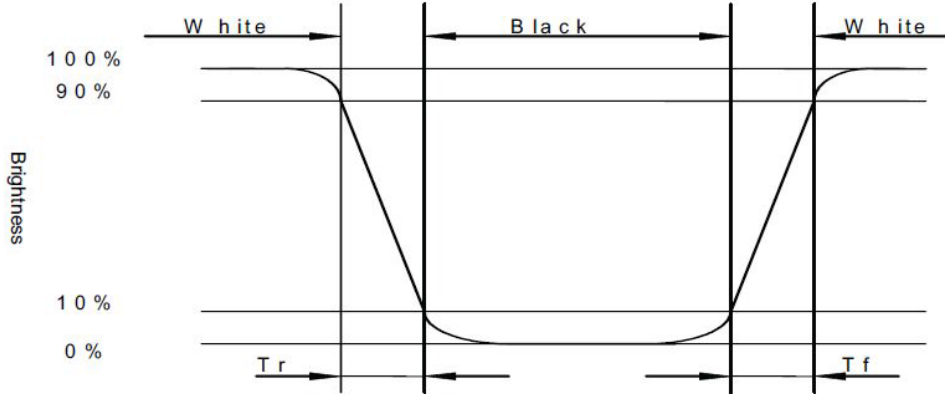

Note 4: Viewing angle range is defined as follow:

Viewing angle is measured at the center point of the LCD.

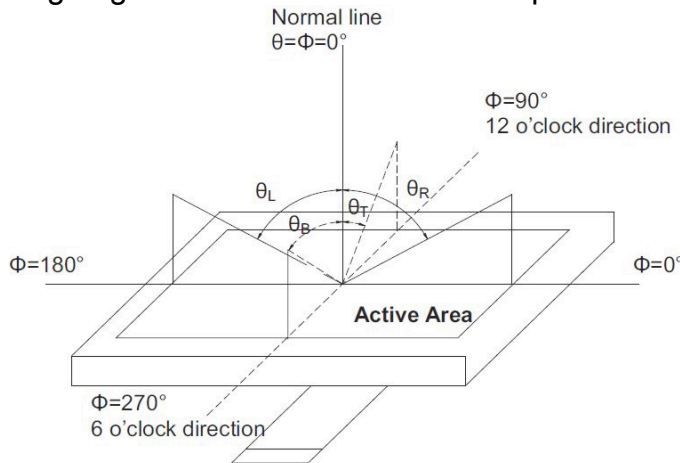

Note 5: Color chromaticity is defined as follow (CIE1931)

Color coordinates measured at center point of LCD.

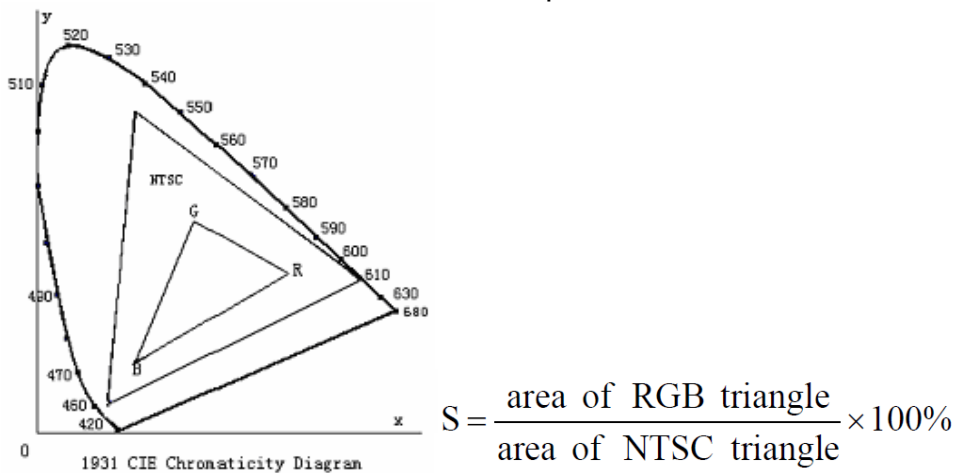

Note 6: Luminance is defined as follow:

Luminance is defined as the brightness of all pixels “White” at the center of display area on optimum contrast.

Note 7: Luminance Uniformity is defined as follow:

Active area is divided into 9 measuring areas (Refer Fig.2). Every measuring point is placed at the center of each measuring area.

$$\text{Uniformity (U)} = \frac{\text{Minimum Luminance( brightness ) in 9 points}}{\text{Maximum Luminance( brightness ) in 9 points}}$$

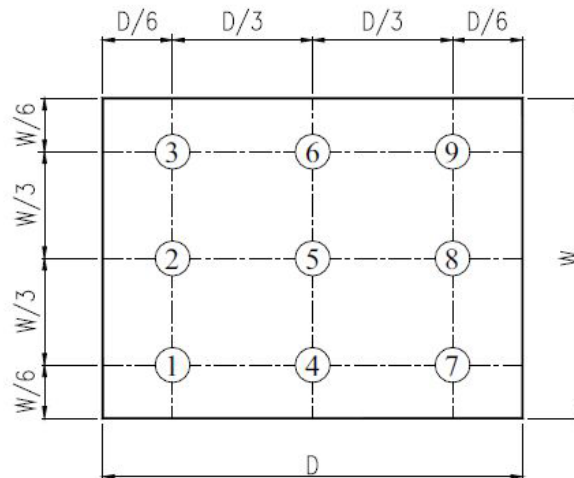

Fig. 2 Definition of uniformity

### 10. Environmental / Reliability Tests

No	Test Item	Condition	Judgment Criteria
1	High Temp Operation	Ta=+70°C, 120hrs	Per table below
2	Low Temp Operation	Ta=-20°C, 120hrs	Per table below
3	High Temp Storage	Ta=+80°C, 120hrs	Per table below
4	Low Temp Storage	Ta=-30°C, 120hrs	Per table below
5	High Temp & High Humidity Storage	Ta=+60°C, 90% RH, 120hrs	Per table below (polarizer discoloration is excluded)
6	Thermal Shock (Non-operation)	-30°C 30 min ~ +80°C 30 min, Change time: 5 min, 10 cycles	Per table below
7	ESD (Operation)	C=150pF, R=330Ω, 5points/panel Air: ±8KV, 5times; Contact: ±4KV, 5 times;	Per table below
8	Vibration (Non-operation)	Frequency range: 10~55Hz, Stroke: 1.5mm Sweep: 10Hz~55Hz~10Hz 2 hours for each direction of X.Y.Z.	Per table below
9	Shock (Non-operation)	60G 6ms, ±X,±Y,±Z 3times, for each direction	Per table below
10	Package Drop Test	Height: 80cm, 1 corner, 3 edges, 6 surfaces	Per table below

Inspection	Criterion (after test)
Appearance	No crack on the FPC, on the LCD panel
Alignment of LCD panel	No bubbles in the LCD panel No other defects of alignment in active area
Electrical current	Within device specifications
Function / Display	No broken circuit, no short circuit or no black line No other defects of display

## 11. Precautions for Use of LCD Modules

### 11.1 Safety

The liquid crystal in the LCD is poisonous. Do not put it in your mouth. If the liquid crystal touches your skin or clothes, wash it off immediately using soap and water.

### 11.2 Handling

- a. The LCD and touch panel is made of plate glass. Do not subject the panel to mechanical shock or to excessive force on its surface.
- b. Do not handle the product by holding the flexible pattern portion in order to assure the reliability.
- c. Transparency is an important factor for the touch panel. Please wear clear finger sacks, gloves and mask to protect the touch panel from finger print or stain and also hold the portion outside the view area when handling the touch panel.
- d. Provide a space so that the panel does not come into contact with other components.
- e. To protect the product from external force, put a covering lens (acrylic board or similar board) and keep an appropriate gap between them.
- f. Transparent electrodes may be disconnected if the panel is used under environmental conditions where dew condensation occurs.
- g. Property of semiconductor devices may be affected when they are exposed to light, possibly resulting in IC malfunctions.
- h. To prevent such IC malfunctions, your design and mounting layout shall be done in the way that the IC is not exposed to light in actual use.

### 11.3 Static electricity

- a. Ground soldering iron tips, tools and testers when they are in operation.
- b. Ground your body when handling the products.
- c. Power on the LCD module before applying the voltage to the input terminals.
- d. Do not apply voltage which exceeds the absolute maximum rating.
- e. Store the products in an anti-electrostatic bag or container.

### 11.4 Storage

- a. Store the products in a dark place at  $+25^{\circ}\text{C}\pm 10^{\circ}\text{C}$  with low humidity (40% RH to 60% RH). Don't expose to sunlight or fluorescent light.
- b. Storage in a clean environment, free from dust, active gas, and solvent.

### 11.5 Cleaning

- a. Do not wipe the touch panel with dry cloth, as it may cause scratch.
- b. Wipe off the stain on the product by using soft cloth moistened with ethanol. Do not allow ethanol to get in between the upper film and the bottom glass. It may cause peeling issue or defective operation. Do not use any organic solvent or detergent other than ethanol.

### 11.6 Cautions for installing and assembling

- a. Bezel edge must be positioned in the area between the Active area and View area. The bezel may press the touch screen and cause activation if the edge touches the active area. A gap of approximately 0.5mm is needed between the bezel and the top electrode. It may cause unexpected activation if the gap is too narrow. There is a tolerance of 0.2 to 0.3mm for the outside dimensions of the touch panel and tail. A gap must be made to absorb the tolerance in the case and connector.
- b. In order to make the display assembly stable and firm, Displaytech recommends to design some supporting at the display backside, especially for the display with tape-attached touch panel, such supporting is important and essential, or else, the display may drop-off from front after some period of time.

- c. Do not display the fixed pattern for a long time because it may develop image sticking due to the LCD structure. If the screen is displayed with fixed pattern, use a screen saver.

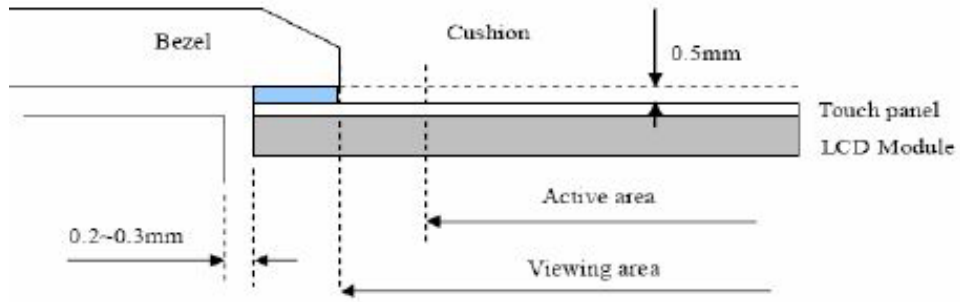

## X-ON Electronics

Largest Supplier of Electrical and Electronic Components

*Click to view similar products for [TFT Displays & Accessories category](#):*

*Click to view products by [Displaytech manufacturer](#):*

Other Similar products are found below :

[F3ET2-005-150](#) [HDA430T-3G1H](#) [NL8048AC19-14F](#) [NL6448BC20-21D](#) [NB7W-KBA04](#) [NB-ATT01](#) [NB5Q-ATT01](#) [NB5Q-KBA04](#) [NB-CN001](#) [OAI-80038AA-2008-A](#) [315-U004B15300](#) [UMSH-8596MD-34T \(REV D\)](#) [TX14D23VM5BAA](#) [TCG121WXLRXVNNANX35](#) [EIC-LCD-1080P](#) [T-55619GD065J-LW-ABN](#) [TCG104SVLPEANN-AN30](#) [NL6448BC33-70](#) [NL6448BC20-30D](#) [NL10276BC16-06](#) [NL192108AC10-01D](#) [NL12880BC20-05BD](#) [NL8060BC26-35BA](#) [NL8060BC31-50F](#) [TM070DDHG03-40](#) [PTPW16-070WV1S02](#) [PTPW17-070WV1S02](#) [PTPW16-084SV1S02](#) [MTD0300ECP06DF-1](#) [DEM 640480E](#) [TMH-PW-N \(A-TOUCH\)](#) [RFA6400E-AWH-DNG](#) [RFA6400E-AWH-MNN](#) [RFE430V-AZW-DNS](#) [RFF70VA2-1IW-DHS](#) [RFH1010J-AYH-MNB](#) [RFH700A8-AYH-MNN](#) [RFK101VF-1YH-LHG](#) [RFS390C-AIW-DNN](#) [RFS390C-AIW-DNS](#) [RFS52VA-1ZH-DHN](#) [SM-RVT101HVHFWCA0](#) [SM-RVT101HVHFWN00](#) [SM-RVT101HVHNWC00](#) [SM-RVT101HVHNWC00-B](#) [SM-RVT101HVHNWCA0](#) [SM-RVT101HVHNWN00](#) [SM-RVT101HVLFWCA0](#) [SM-RVT101HVLNWCA0](#) [SM-RVT3.5A320240TFWN00](#) [SM-RVT35HHTFWCA0](#)