

A	工程变更通知单	版本	日期	说明	承认
	ECN(DCN) NO.	REV	DATE	DESCRIPTION	CHANGE APPRO.
B	—	A	20140918	NEW	—
C	KSECN16067	B	20160927	后盖增加逃料	万小龙
D				后盖增加逃料	王永辉

DSB4N D-15 L S1 Y N3 *

① PRODUCTION CODE (产品编码):

② CHARACTER (特征): DSB4N: D-SUB-15PIN(3.0) CONN

D: DIP TYPE

③ POSITION (位号): 15: 15PIN

④ COLOR OF HOUSING(本体颜色):

⑤ PLATING OF CONTACT(端子电镀):

⑥ PACKAGE(包装): Y: TRAY PACKAGE

⑦ PLATING OF SHELL(铁壳电镀):

⑧ TYPE:

0: 无镀层

1: 镀镍层

4: 附镀层

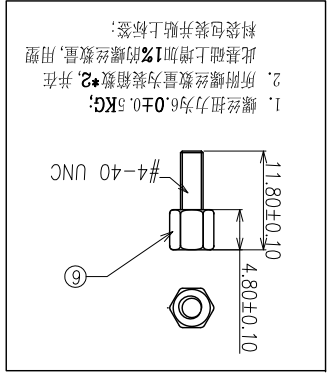

螺丝规格

⑧ TYPE:

⑦ PLATING OF SHELL(铁壳电镀):

Y: TRAY PACKAGE

⑥ PACKAGE(包装):

⑤ PLATING OF CONTACT(端子电镀):

④ COLOR OF HOUSING(本体颜色):

③ POSITION (位号):

15: 15PIN

② CHARACTER (特征):

DSB4N: D-SUB-15PIN(3.0) CONN

D: DIP TYPE

③ POSITION (位号):

15: 15PIN

④ COLOR OF HOUSING(本体颜色):

⑤ PLATING OF CONTACT(端子电镀):

⑥ PACKAGE(包装):

Y: TRAY PACKAGE

⑦ PLATING OF SHELL(铁壳电镀):

⑧ TYPE:

0: 无镀层

1: 镀镍层

4: 附镀层

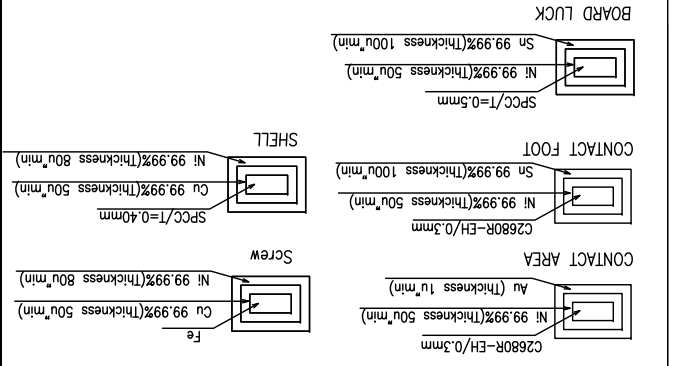
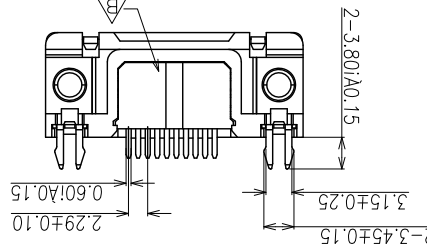
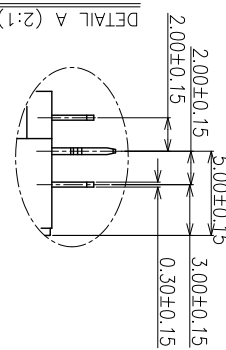
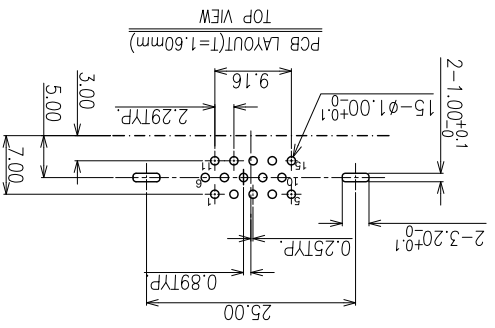
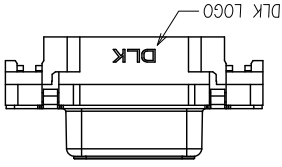
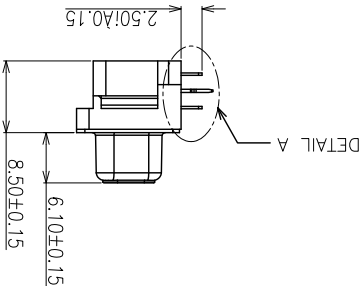
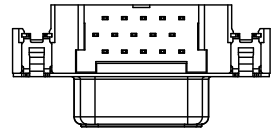
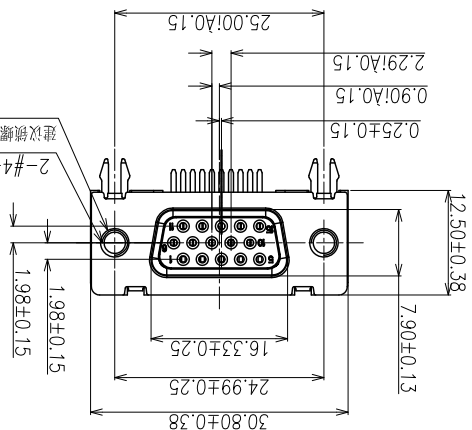

电镀规格:

NO.	ITEM	Q'TY	DESCRIPTION	FINISH	UNIT:	SCALE	SHEET: 1 of 1
1	Housing	1	PBT	UL94V-0,BLUE	.XXX ±0.10	mm	
2	Cover	1	PBT	UL94V-0,BLUE	.XX ±0.25	mm	
3	Shell	1	FERROALLOY	Ni PLATED	.X ±0.38	mm	
4	Contact	15	COPPER ALLOY	Au And Tin plated	X. ±0.50	mm	
5	BOARD LUCK	2	FERROALLOY	Tin PLATED	Angle ±5°	mm	
6	Screw	2	FERROALLOY	Nickel plated	UNLESS OTHERWISE NOTED	mm	

名称	D-SUB R/A 12.5H CONN
料号	C-DSB4N-00-00
零件号	DSB4ND-15L1YN3*
批准	王永辉
批准	王永辉
批准	王永辉

X-ON Electronics

Largest Supplier of Electrical and Electronic Components

Click to view similar products for [dlk manufacturer](#):

Other Similar products are found below :

[ACT3KD-03BT3Y032HPF](#) [HDM41A-19BM4RN17](#) [HDM2TA-19BM4YN18](#) [U3A20D-09LM5YN2FHF](#) [DSB4ND-15BM1YN30](#) [DSB46C-15LS1YN37](#) [DPT21C-20BM1YN11](#) [ACT5MD-03BL3B003](#) [DVI2DD-24WM1YN4A](#) [DVI28D-24HS1YN4G](#) [U3B22D-09BM5YN20HF](#) [HDM2CB-21BM4YN13](#) [HDM2TA-19BM4YN10](#) [HDM2TA-19BM4YN17](#) [DSB4ND-15LM1YN30HF](#) [HDM41A-19BM4YN15](#) [U3C61B-24BM1RN11](#) [U3C61B-24BM1RN12](#) [DPT22A-20BM4YN11](#) [DPT22A-20BM4YN10](#) [DPT28A-20BM4YN10](#) [U3A20D-09BM4YN2EHF](#) [U3A20D-09BM5YN2HHF](#) [DVI28D-24HS1YN40](#) [DVI2AD-24HS1YN43HF](#) [DVI2DD-24WM1YN40](#) [HDM41A-19BM1RN16](#) [HDM45A-19BM4RN10](#) [U3A20D-09LM5YN2D](#) [U3A20D-09YM5RN21](#) [U3B22D-09BM4YN22HF](#) [U3B22D-09LM1YN24HF](#) [U3B23C-09BM5YN22](#) [U3A27C-09LM5YN25](#) [U3B23C-09LM5YN22](#) [U3B22D-09LM5YN21HF](#) [DSB4WD-15LM1YN34](#) [DSB6RD-15LM1YN32HF](#) [DSB6AC-15LM1YN32](#) [DSB4YC-15LM1YN3AHF](#) [DSB4ND-15BM1YN30HF](#) [DSB4MD-15BM1YN30HF](#) [DSB4WD-15LM1YN34HF](#) [DSB6RD-15LM1YN32](#) [DSB6RD-15BM1YN30HF](#) [DSB46C-15LS1YN37HF](#) [DSB6RD-15LM1YN30](#) [DSB47C-15BS1YN3G](#) [ACT1MD-02BL4B016](#) [ACT1SD-02BL4B007HP](#)