

符合“DLK环境管理物质技术标准”

符合“IEC协会标准”

工程变更通知单	版本	日期	说明
ECN(DCN) NO.	REV	DATE	DESCRIPTION
KSECN16067	A	20140918	NEW
B		20160927	后盖增加速料 $\nabla$ *1
			万小龙 王永辉

DSB4N D-15 L S1 Y N3 \*  
 ① ② ③ ④ ⑤ ⑥ ⑦ ⑧

① PRODUCTION CODE (产品编码):  
 DSB4N: D-SUB-15PIN(3.0) CONN

② CHARACTER (特征):  
 D: DIP TYPE

③ POSITION (位号):  
 15: 15PIN

④ COLOR OF HOUSING(本体颜色):  
 L: BLUE COLOR

⑤ PLATING OF CONTACT(端子电镀):  
 S1: GOLD FLASH AND TIN PLATED (镀金锡)

⑥ PACKAGE(包装):  
 Y: TRAY PACKAGE

⑦ PLATING OF SHELL(铁壳电镀):  
 N3:NI PLATD

⑧ TYPE:  
 0: 无镀层  
 1: 镀镍层  
 4: 附镀层

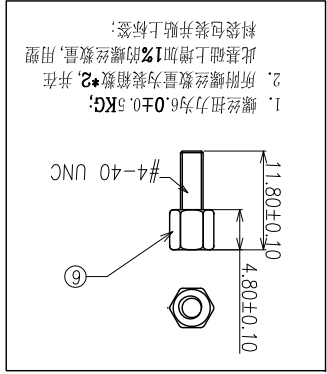

螺丝规格

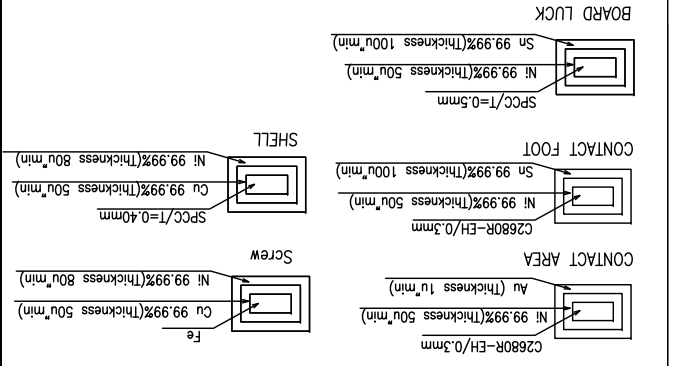
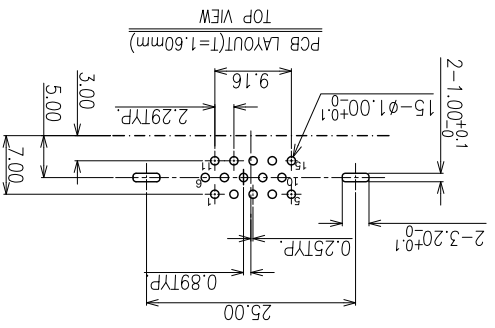
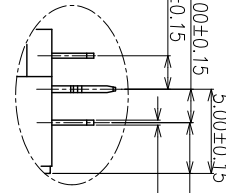
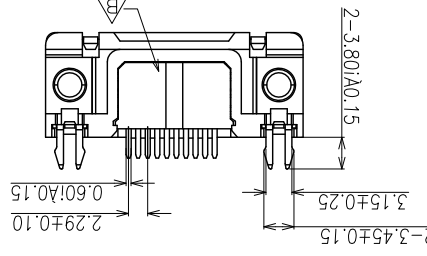
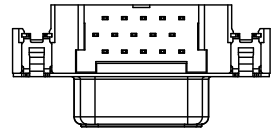
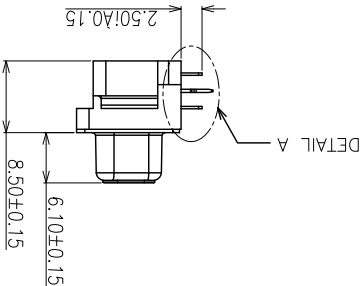
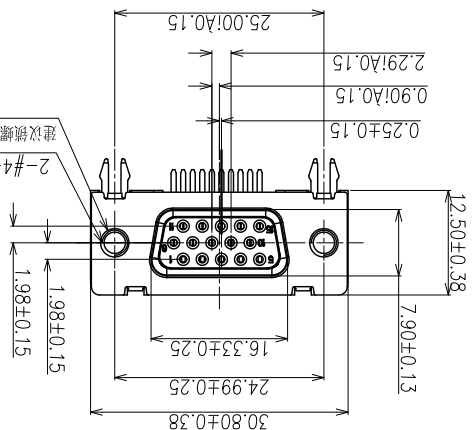
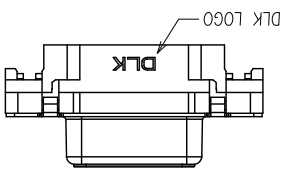
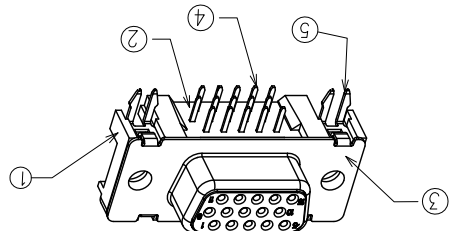

电镀规格:

NO.	ITEM	Q'TY	DESCRIPTION	FINISH	UNIT:	SCALE	SHEET: 1 of 1
1	Housing	1	PBT	UL94V-0,BLUE	.XXX	mm	
2	Cover	1	PBT	UL94V-0,BLUE	.XX	mm	
3	Shell	1	FERROALLOY	NI PLATED	.X	mm	
4	Contact	15	COPPER ALLOY	Au And Tin plated	±0.50	mm	
5	BOARD LUCK	2	FERROALLOY	Tin PLATED	Angle	mm	
6	Screw	2	FERROALLOY	Nickel plated	UNLESS OTHERWISE NOTED	mm	

德力康电子科技有限公司  
 DLK DELIKANG ELECTRONICS TECHNOLOGY CO.,LTD  
 D-SUB R/A 12.5H CONN  
 名称: D-SUB R/A 12.5H CONN  
 料号: C-DSB4N-00-00  
 零件号: DSB4ND-15L1YN3\*  
 批准: 王永辉  
 更改: 王永辉  
 承认: 王永辉

## X-ON Electronics

Largest Supplier of Electrical and Electronic Components

*Click to view similar products for [dlk manufacturer](#):*

Other Similar products are found below :

[ACT3KD-03BT3Y032HPF](#) [HDM41A-19BM4RN17](#) [HDM2TA-19BM4YN18](#) [U3A20D-09LM5YN2FHF](#) [DSB4ND-15BM1YN30](#) [DSB46C-15LS1YN37](#) [DPT21C-20BM1YN11](#) [ACT5MD-03BL3B003](#) [DVI2DD-24WM1YN4A](#) [DVI28D-24HS1YN4G](#) [U3B22D-09BM5YN20HF](#) [HDM2CB-21BM4YN13](#) [HDM2TA-19BM4YN10](#) [HDM2TA-19BM4YN17](#) [DSB4ND-15LM1YN30HF](#) [HDM41A-19BM4YN15](#) [U3C61B-24BM1RN11](#) [U3C61B-24BM1RN12](#) [DPT22A-20BM4YN11](#) [DPT22A-20BM4YN10](#) [DPT28A-20BM4YN10](#) [U3A20D-09BM4YN2EHF](#) [U3A20D-09BM5YN2HHF](#) [DVI28D-24HS1YN40](#) [DVI2AD-24HS1YN43HF](#) [DVI2DD-24WM1YN40](#) [HDM41A-19BM1RN16](#) [HDM45A-19BM4RN10](#) [U3A20D-09LM5YN2D](#) [U3A20D-09YM5RN21](#) [U3B22D-09BM4YN22HF](#) [U3B22D-09LM1YN24HF](#) [U3B23C-09BM5YN22](#) [U3A27C-09LM5YN25](#) [U3B23C-09LM5YN22](#) [U3B22D-09LM5YN21HF](#) [DSB4WD-15LM1YN34](#) [DSB6RD-15LM1YN32HF](#) [DSB6AC-15LM1YN32](#) [DSB4YC-15LM1YN3AHF](#) [DSB4ND-15BM1YN30HF](#) [DSB4MD-15BM1YN30HF](#) [DSB4WD-15LM1YN34HF](#) [DSB6RD-15LM1YN32](#) [DSB6RD-15BM1YN30HF](#) [DSB46C-15LS1YN37HF](#) [DSB6RD-15LM1YN30](#) [DSB47C-15BS1YN3G](#) [ACT1MD-02BL4B016](#) [ACT1SD-02BL4B007HP](#)