

技术特性/Specifications:

额定电压 Rated voltage: 250V AC, DC
额定电流 Rated current: 3A AC, DC
接触电阻 Contact resistance: 20mΩ max
绝缘电阻 Insulation resistance: 1000MΩ min
耐压 Withstand voltage: 1000V AC/minute
环境温度 Ambient temperature: -40℃~+105℃
适用线规 Wire range: AWG#28~#22

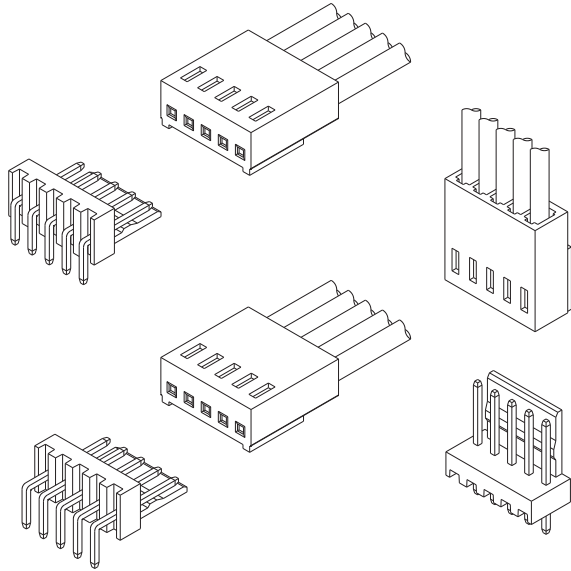

REV.	REVISION DESCRIPTION	DATE	APPD
A0	NEW RELEASE	2009.08.01	张仁川

NOTES

Available in 02 through 20 Circuits.

Mates with DL25401-Y Series Housing.

Material : Nylon UL94V-0(2).

0.64mm Square Pin.

Pin Material : Brass / Tin-Plated.

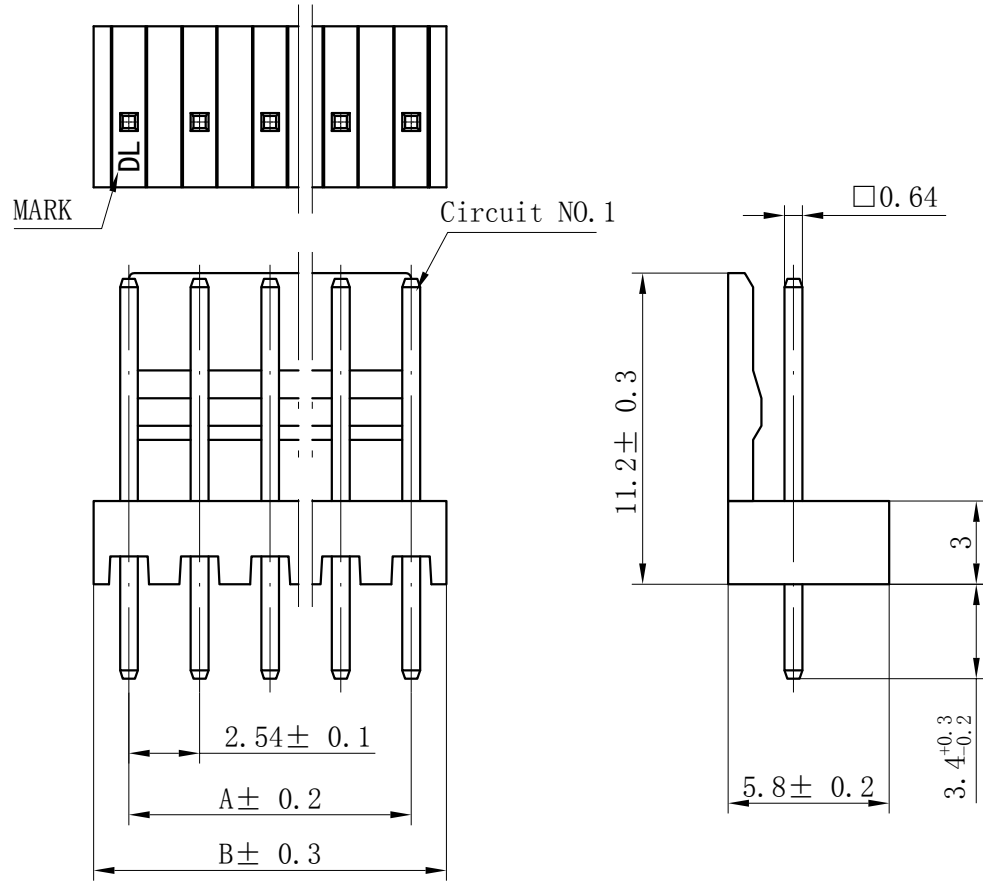

Circuits	Product name	Dimension mm		Circuits	Product name	Dimension mm	
		A	B			A	B
2	2510-2A	2.54	5.08	12	2510-12A	27.94	30.48
3	2510-3A	5.08	7.62	13	2510-13A	30.48	33.02
4	2510-4A	7.62	10.16	14	2510-14A	33.02	35.56
5	2510-5A	10.16	12.70	15	2510-15A	35.56	38.10
6	2510-6A	12.70	15.24	16	2510-16A	38.10	40.64
7	2510-7A	15.24	17.78	17	2510-17A	40.64	43.18
8	2510-8A	17.78	20.32	18	2510-18A	43.18	45.72
9	2510-9A	20.32	22.86	19	2510-19A	45.72	48.26
10	2510-10A	22.86	25.40	20	2510-20A	48.26	50.80
11	2510-11A	25.40	27.94				

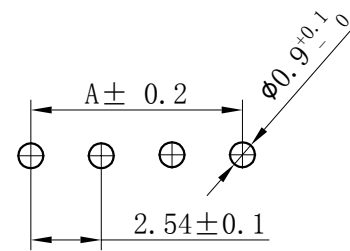

PCB LAYOUT

GENERAL TOLERANCES (UNLESS SPECIFIED)		ZHE JIANG DELI CONNECTORS CO., LTD	
.X: ± 0.25	.X°: ± 3.0°	PRODUCT NAME: DL25401 (2510)-A	TITLE: 2.54 mm Pitch Wire To Board Wafer
.XX: ± 0.15	.XX°: ± 2.0°	DR: Xian Qiang	DATE:09/08/01
.XXX: ± 0.01	.XXX°: ± 1.0°	CHRD: Liu Bing	DATE:09/08/01
DRAWING NO:		APPD:Ren An De	DATE:09/08/01
		SCALE: N/A	PAGE: 1/1
		UNITS: mm	REV.: A0

REV.	REVISION DESCRIPTION	DATE	APPD

NOTES

Available in 02 through 20 Circuits.
 Mates with DL25401-Y Series Housing.
 Material : Nylon UL94V-0(2).
 0.64mm Square Pin.
 Pin Material : Brass / Tin-Plated.

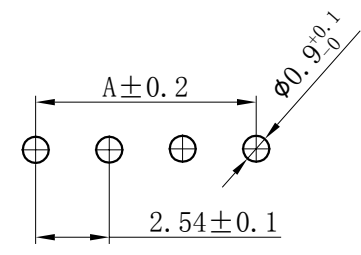

PCB LATOUT

Circuits	Product name	Dimension mm		Circuits	Product name	Dimension mm	
		A	B			A	B
2	2510-2AW	2.54	5.08	12	2510-12AW	27.94	30.48
3	2510-3AW	5.08	7.62	13	2510-13AW	30.48	33.02
4	2510-4AW	7.62	10.16	14	2510-14AW	33.02	35.56
5	2510-5AW	10.16	12.70	15	2510-15AW	35.56	38.10
6	2510-6AW	12.70	15.24	16	2510-16AW	38.10	40.64
7	2510-7AW	15.24	17.78	17	2510-17AW	40.64	43.18
8	2510-8AW	17.78	20.32	18	2510-18AW	43.18	45.72
9	2510-9AW	20.32	22.86	19	2510-19AW	45.72	48.26
10	2510-10AW	22.86	25.40	20	2510-20AW	48.26	50.80
11	2510-11AW	25.40	27.94				

GENERAL TOLERANCES (UNLESS SPECIFIED)		ZHE JIANG DELI CONNECTORS CO.,LTD			
.X: ± 0.25	.X°: ± 3.0°	PRODUCT NAME: DL25401(2510)-AW		TITLE: 2.54 mm Pitch Wire To Board Wafer	
.XX: ± 0.15	.X°: ± 2.0°	DR: Xian Qiang	DATE:09/08/01	PART NO:	
.XXX: ± 0.01	.XX°: ± 1.0°	CHKD: Liu Bing	DATE:09/08/01	SCALE: N/A	PAGE: 1/1
DRAWING NO:		APPD:Ren An De	DATE:09/08/01	UNITS: mm	REV.: A

REV.	REVISION DESCRIPTION	DATE	APPD

NOTES

Available in 02 through 20 Circuits.
 Mates with DL25401-Y Series Housing.
 Material : Nylon UL94V-0(2).
 0.64mm Square Pin.
 Pin Material : Brass / Tin-Plated.

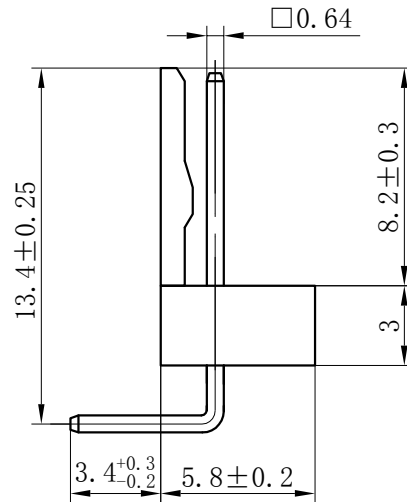
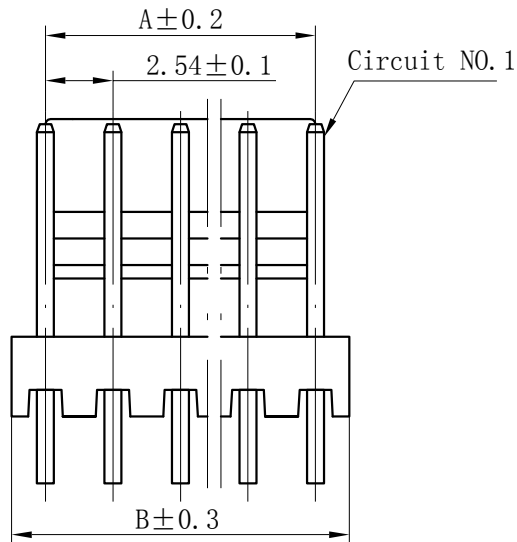
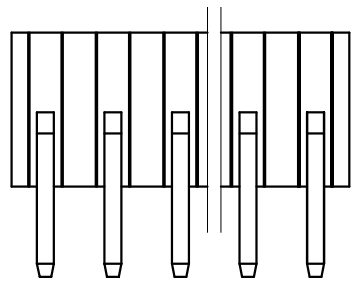

PCB LATOUT

Circuits	Product name	Dimension mm		Circuits	Product name	Dimension mm	
		A	B			A	B
2	2510-2AWT	2.54	5.08	12	2510-12AWT	27.94	30.48
3	2510-3AWT	5.08	7.62	13	2510-13AWT	30.48	33.02
4	2510-4AWT	7.62	10.16	14	2510-14AWT	33.02	35.56
5	2510-5AWT	10.16	12.70	15	2510-15AWT	35.56	38.10
6	2510-6AWT	12.70	15.24	16	2510-16AWT	38.10	40.64
7	2510-7AWT	15.24	17.78	17	2510-17AWT	40.64	43.18
8	2510-8AWT	17.78	20.32	18	2510-18AWT	43.18	45.72
9	2510-9AWT	20.32	22.86	19	2510-19AWT	45.72	48.26
10	2510-10AWT	22.86	25.40	20	2510-20AWT	48.26	50.80
11	2510-11AWT	25.40	27.94				

GENERAL TOLERANCES (UNLESS SPECIFIED)		ZHE JIANG DELI CONNECTORS CO., LTD			
.X: ± 0.25	X°: ± 3.0°	PRODUCT NAME: DL25401 (2510)-AWT		TITLE: 2.54 mm Pitch Wire To Board Wafer	
.XX: ± 0.15	.X°: ± 2.0°	DR: Xian Qiang	DATE: 09/08/01	PART NO:	
.XXX: ± 0.01	.XX°: ± 1.0°	CHKD: Liu Bing	DATE: 09/08/01	SCALE: N/A	PAGE: 1/1
DRAWING NO:		APPD: Ren An De	DATE: 09/08/01	UNITS: mm	REV.: A

REV.	REVISION DESCRIPTION	DATE	APPD

NOTES

Available in 02 through 20 Circuits.
 Mates with DL25401-A or DL25401-AW or DL25401-AWT Series WAFER.
 Material :Nylon UL94-V0(2).
 Accepts DL25401-T Crimp Terminal.

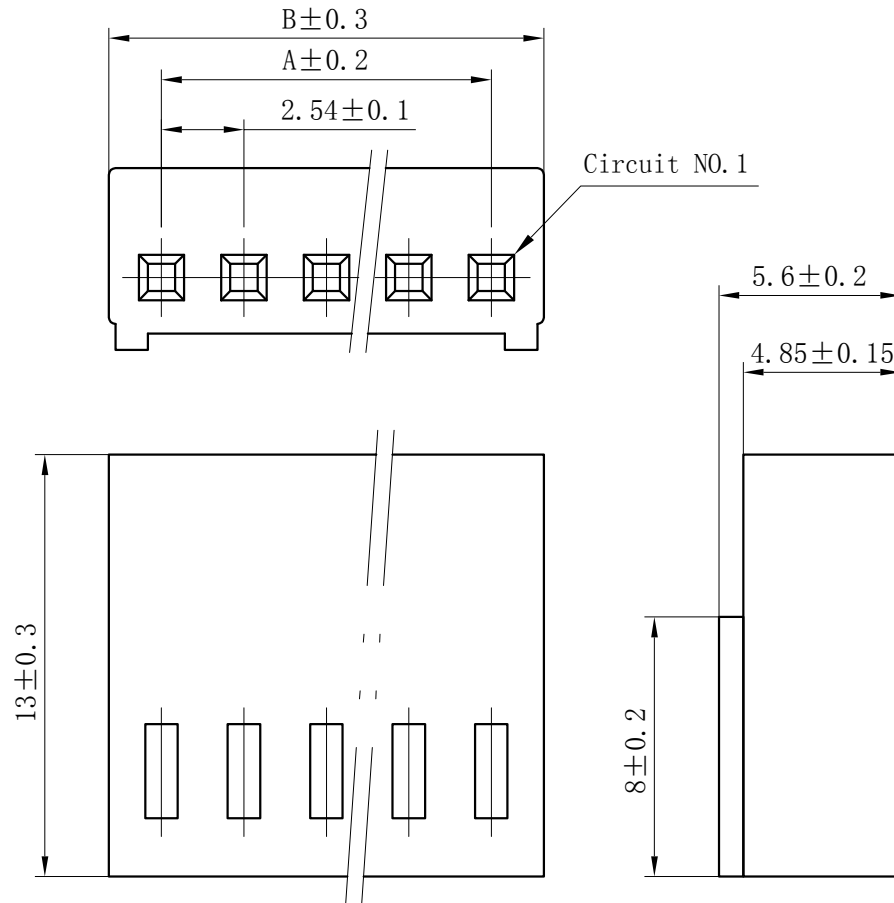
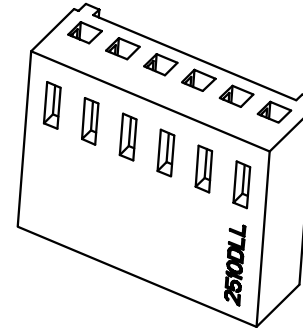

Circuits	Product name	Dimension mm		Circuits	Product name	Dimension mm	
		A	B			A	B
2	2510-2Y	2.54	5.84	10	2510-10Y	22.86	26.16
3	2510-3Y	5.08	8.38	11	2510-11Y	25.40	28.70
4	2510-4Y	7.62	10.92	12	2510-12Y	27.94	31.24
5	2510-5Y	10.16	13.46	13	2510-13Y	30.48	33.78
6	2510-6Y	12.70	16.00	14	2510-14Y	33.02	36.32
7	2510-7Y	15.24	18.54	15	2510-15Y	35.56	38.86
8	2510-8Y	17.78	21.08	~	~	~	~
9	2510-9Y	20.32	23.62	20	2510-20Y	48.26	51.56

GENERAL TOLERANCES (UNLESS SPECIFIED)		ZHE JIANG DELI CONNECTORS CO., LTD	
.X: ± 0.25	X°: ± 3.0°	PRODUCT NAME: DL25401 (2510)-Y	TITLE: 2.54 mm Pitch Wire To Board Housing
.XX: ± 0.15	.X°: ± 2.0°	DR: Xian Qiang	DATE:09/08/01
.XXX: ± 0.01	.XX°: ± 1.0°	CHKD: Liu Bing	DATE:09/08/01
FINISH:		APPD: Ren An De	DATE:09/08/01
DRAWING NO:		SCALE: N/A	PAGE: 1/1
		UNITS: mm	REV.: A0

REV.	REVISION DESCRIPTION	DATE	APPD

NOTES

Available in 02 through 20 Circuits.
 Mates with DL25401-A or DL25401-AW or DL25401-AWT Series WAFER.
 Material :Nylon UL94-V0(2).
 Accepts DL25401-T Crimp Terminal.

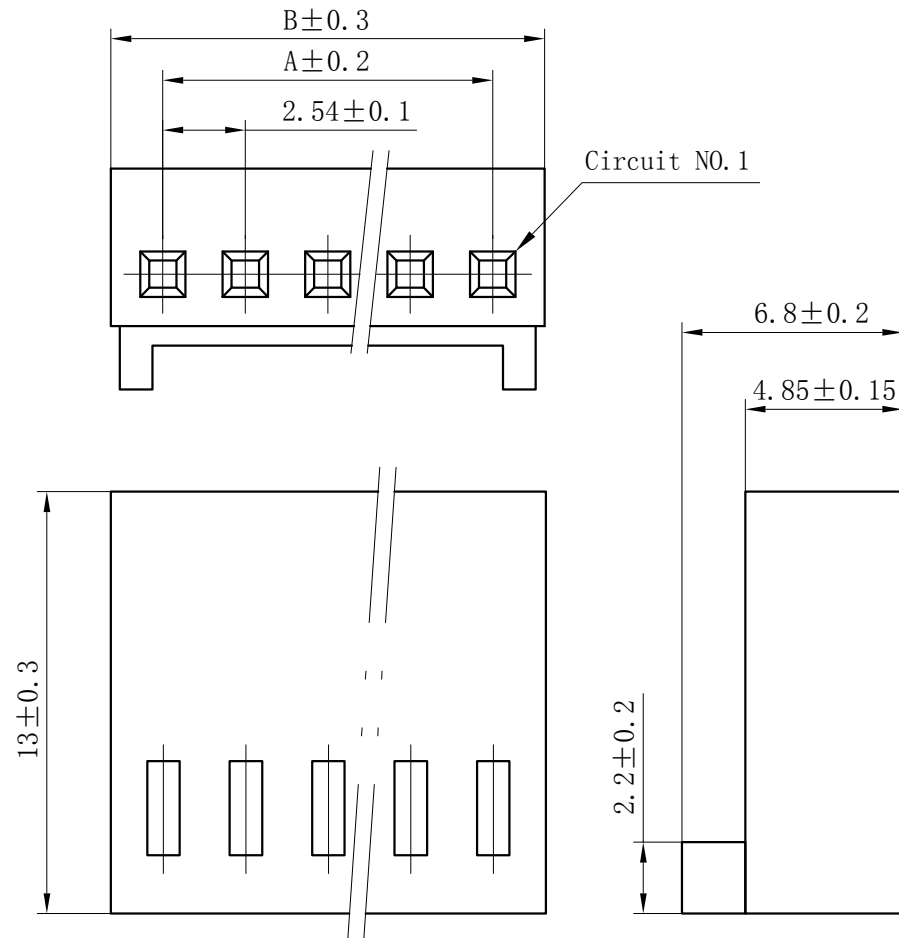
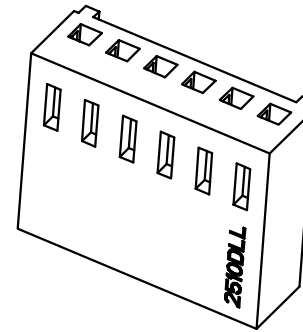

Circuits	Product name	Dimension mm		Circuits	Product name	Dimension mm	
		A	B			A	B
2	2510-2YB	2.54	5.84	10	2510-10YB	22.86	26.16
3	2510-3YB	5.08	8.38	11	2510-11YB	25.40	28.70
4	2510-4YB	7.62	10.92	12	2510-12YB	27.94	31.24
5	2510-5YB	10.16	13.46	13	2510-13YB	30.48	33.78
6	2510-6YB	12.70	16.00	14	2510-14YB	33.02	36.32
7	2510-7YB	15.24	18.54	15	2510-15YB	35.56	38.86
8	2510-8YB	17.78	21.08	~	~	~	~
9	2510-9YB	20.32	23.62	20	2510-20YB	48.26	51.56

GENERAL TOLERANCES (UNLESS SPECIFIED)		ZHE JIANG DELI CONNECTORS CO., LTD	
.X: ± 0.25	X°: ± 3.0°	PRODUCT NAME: DL25401 (2510)-YB	TITLE: 2.54 mm Pitch Wire To Board Housing
.XX: ± 0.15	.X°: ± 2.0°	DR: Xian Qiang	DATE:09/08/01
.XXX: ± 0.01	.XX°: ± 1.0°	CHKD: Liu Bing	DATE:09/08/01
FINISH:		APPD: Ren An De	DATE:09/08/01
DRAWING NO:		SCALE: N/A	PAGE: 1/1
		UNITS: mm	REV.: A0

REV.	REVISION DESCRIPTION	DATE	APPD

NOTES

Mates with 2510 Series Housing.
 Material : Nylon UL94V-0(2).
 Green Material RoHS Compliant.

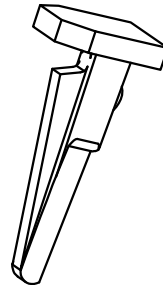
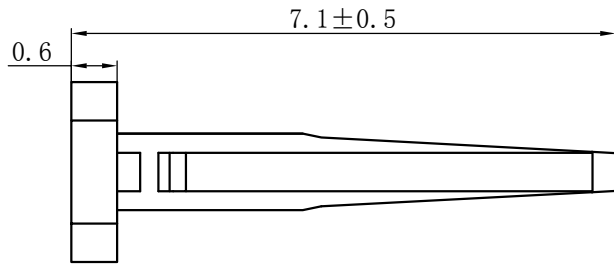
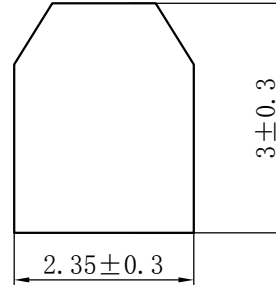
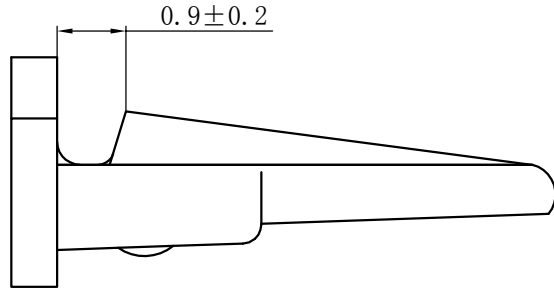

GENERAL TOLERANCES (UNLESS SPECIFIED)		ZHE JIANG DELI CONNECTORS CO., LTD	
.X: ± 0.30	X° : ± 3.0°	PRODUCT NAME: DL25401 (2510)-1E	TITLE: 2.54 mm Pitch WTW Receptacle Stopper
.XX: ± 0.15	.X° : ± 2.0°	DR:Chen Quan Long	DATE:24. 2. 22
.XXX: ± 0.01	.XX° : ± 1.0°	CHKD:Wu Hui	DATE:24. 2. 22
FINISH:		APPD:Ren An De	DATE:24. 2. 22
DRAWING NO:		UNITS: mm	SCALE: N/A
			PAGE: 1/1
			REV.: A

REV.	REVISION DESCRIPTION	DATE	APPD
A2	图面更新	2019/08/20	

NOTES

Used in DL25401-Y Series Housing.

Accepts AWG #28~22 Wire Range.

0.06~ 0.33 mm² .

Insulation O.D.=1.2~1.9 mm.

Material : Phosphor Bronze .

Finish: Tin plated.

Thickness: 0.2 mm.

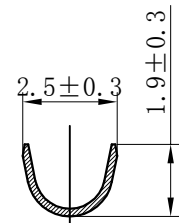
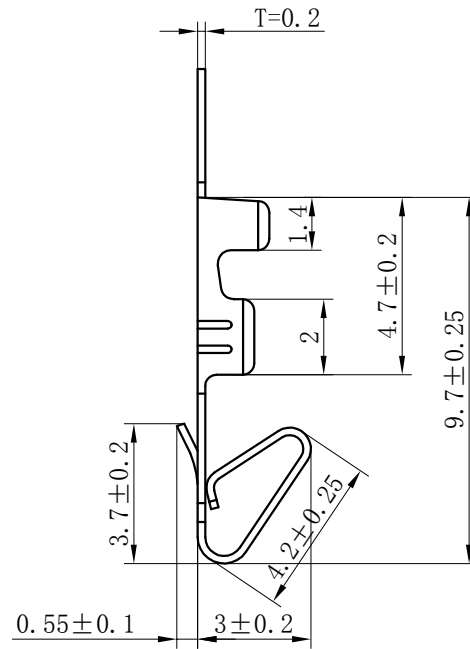
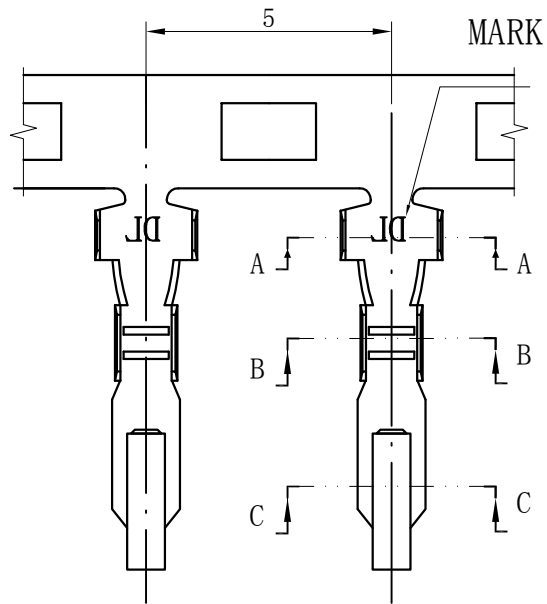

SECTION A-A



SECTION B-B



SECTION C-C

GENERAL TOLERANCES (UNLESS SPECIFIED)		ZHE JIANG DELI CONNECTORS CO., LTD	
.X: ± 0.25	X° : ± 3.0°	PRODUCT NAME:	TITLE:
.XX: ± 0.15	.X° : ± 2.0°	DL25401 (2510)-T	2.54 mm Pitch Wire To Board Crimp Terminal
.XXX: ± 0.01	.XX° : ± 1.0°	DR: Chen Quan Long	DATE: 20.12.4
FINISH:		CHKD: Wu Hui	DATE: 20.12.4
DRAWING NO:		APPD: Ren An De	DATE: 20.12.4
		SCALE: N/A	PAGE: 1/1
		UNITS: mm	REV.: A2

X-ON Electronics

Largest Supplier of Electrical and Electronic Components

Click to view similar products for [Headers & Wire Housings](#) category:

Click to view products by [DLL](#) manufacturer:

Other Similar products are found below :

[0015917161](#) [0022155065](#) [57102-F02-18ULF](#) [58102-G61-06LF](#) [582553-1](#) [01.001.5753.1](#) [0050291907](#) [02.125.8002.8](#) [609-3404](#) [61062-3](#)
[CSU011177004](#) [622-0430](#) [622-3653LF](#) [63453-116](#) [636-1030](#) [636-1427](#) [636-3427](#) [636-4007](#) [641938-9](#) [65495-038](#) [65692-001LF](#) [65781-018](#)
[65781-047](#) [65817-010LF](#) [65817-015LF](#) [67095-007LF](#) [67601157](#) [68631-112](#) [68645-018](#) [699319-000](#) [70.362.1628.0](#) [70-4210](#) [70-4226B](#) [70-](#)
[4853B](#) [71.350.2428.0](#) [733-134](#) [733-162](#) [MHR-64-VUAL](#) [80.063.4001.1](#) [800-90-001-10-001000](#) [801-43-002-10-013000](#) [801-43-006-10-](#)
[002000](#) [803-43-024-10-001000](#) [803-93-012-10-001000](#) [8-1437020-4](#) [819-22-004-30-001101](#) [820-22-006-30-001101](#) [820-22-008-30-001101](#)
[821-22-002-10-001101](#) [821-22-003-10-002101](#)