

技术特性/Specifications:

额定电压 Rated voltage: 300V AC, DC
额定电流 Rated current: 8A AC, DC
接触电阻 Contact resistance: 20mΩ max
绝缘电阻 Insulation resistance: 500MΩ min
耐压 Withstand voltage: 1500V AC/minute
环境温度 Ambient temperature: -40°C~+105°C
适用线规 Wire range: AWG#24~#14

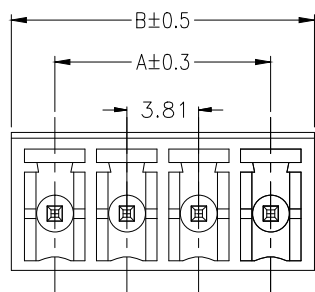

材料及电镀

- ① 塑件主体: PA66, UL94V-0
- ② 焊 针: 黄铜, 镀镍

电气性能

额定电压: 300V
 额定电流: 8A
 接触电阻: 20mΩ (Max)
 绝缘电阻: 500MΩ \DC1000V
 耐 电 压: AC1500V\1min

机械性能

温度范围: -40℃ ~ +105℃
 瞬时温度: +250℃ , 5秒

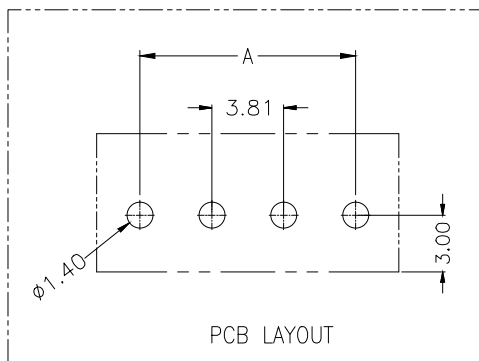
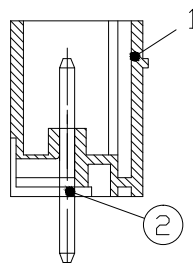
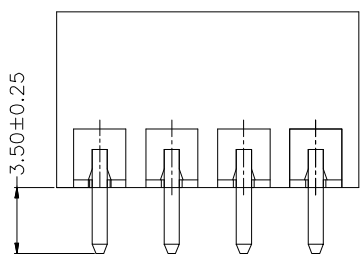
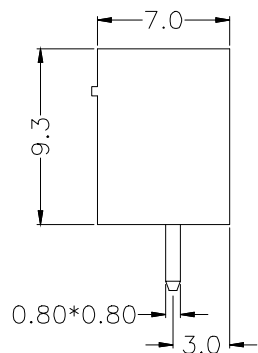

Circuits	Product name	Dimensino (mm)	
		A	B
2	2EDG-3.81-2A	3.81	8.42
3	2EDG-3.81-3A	7.62	12.23
4	2EDG-3.81-4A	11.43	16.04
5	2EDG-3.81-5A	15.24	19.85
6	2EDG-3.81-6A	19.05	23.66
7	2EDG-3.81-7A	22.86	27.47
8	2EDG-3.81-8A	26.67	31.28
9	2EDG-3.81-9A	30.48	35.09
10	2EDG-3.81-10A	34.29	38.90
11	2EDG-3.81-11A	38.10	42.71
12	2EDG-3.81-12A	41.91	46.52
13	2EDG-3.81-13A	45.72	50.33
14	2EDG-3.81-14A	49.53	54.14
15	2EDG-3.81-15A	53.34	57.95
~	~	~	~
24	2EDG-3.81-24A	87.63	92.24

			GENERAL TOLERANCE	制 图 DRAWING	ZHE JIANG DELI CONNECTORS CO., LTD			
			DIM TOL	审 核 CHECK			版 本 REV.	A
			X.X ±0.50	批 准 APPROVAL	产 品 名 称 TITLE	2EDG-3.81-A		
1	初版发行		X.XX ±0.30	比 例 SCALE	产 品 料 号 PART NO.		单 位 UNITS	mm
序号 No.	变 更 内 容 MODIFY CONTENT	日 期 MODIFY DATE	X.XXX ±0.10	投 影 Projection	材 料 MATERIAL		页 次 SHEET	1/1
			Angle ±3.0°					

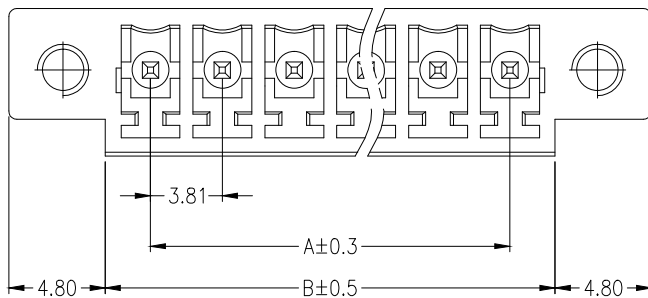

材料及电镀

- ① 塑件主体: PA66, UL94V-0
- ② 焊 针: 黄铜, 镀镍

电气性能

额定电压: 300V
 额定电流: 8A
 接触电阻: 20mΩ (Max)
 绝缘电阻: 500MΩ \DC1000V
 耐 电 压: AC1500V\1Min

机械性能

温度范围: -40℃ ~ +105℃
 瞬时温度: +250℃ , 5秒

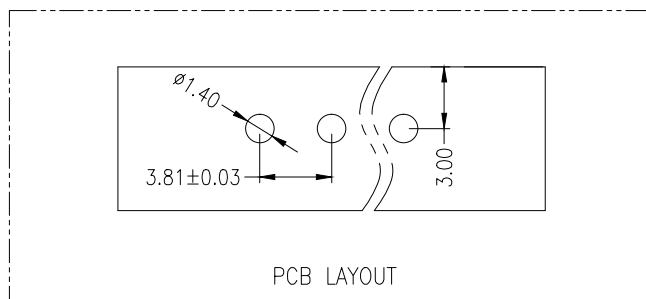
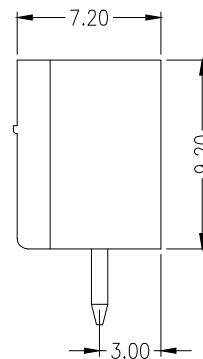
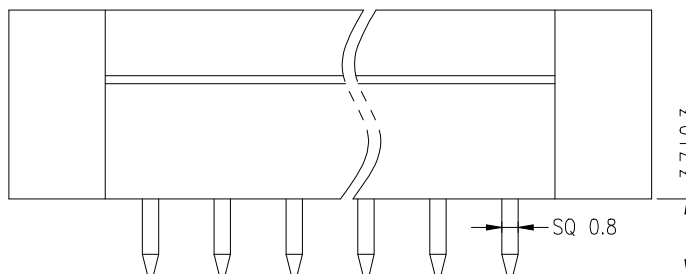

Circuits	Product name	Dimensino (mm)	
		A	B
2	2EDG-3.81-2ALS	3.81	8.62
3	2EDG-3.81-3ALS	7.62	12.43
4	2EDG-3.81-4ALS	11.43	16.24
5	2EDG-3.81-5ALS	15.24	20.05
6	2EDG-3.81-6ALS	19.05	23.86
7	2EDG-3.81-7ALS	22.86	27.67
8	2EDG-3.81-8ALS	26.67	31.48
9	2EDG-3.81-9ALS	30.48	35.29
10	2EDG-3.81-10ALS	34.29	39.10
11	2EDG-3.81-11ALS	38.10	42.91
12	2EDG-3.81-12ALS	41.91	46.72
13	2EDG-3.81-13ALS	45.72	50.53
14	2EDG-3.81-14ALS	49.53	54.34
15	2EDG-3.81-15ALS	53.34	58.15
~	~	~	~
24	2EDG-3.81-24ALS	87.63	92.44

			GENEAL TOLERANCE	制 图 DRAWING	ZHE JIANG DELI CONNECTORS CO ., LTD			
			DIM TOL	审 核 CHECK				
			X.X ±0.50	批 准 APPROVAL	产品名称 TITLE	2EDG-3.81-ALS	版本 REV.	A
1	初版发行		X.XX ±0.30	比 例 SCALE	产品料号 PART NO.		单 位 UNITS	mm
序号 No.	变更内容 MODIFY CONTENT	日期 MODIFY DATE	X.XXX ±0.10	投 影 Projection	材 料 MATERIAL		页 次 SHEET	1/1
			Angle ±3.0°					

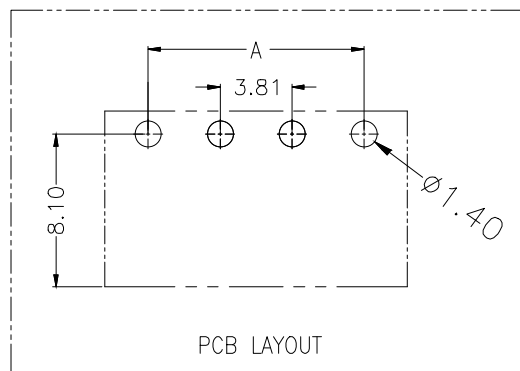
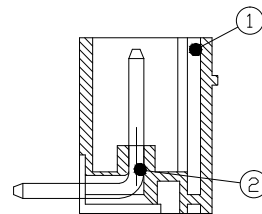
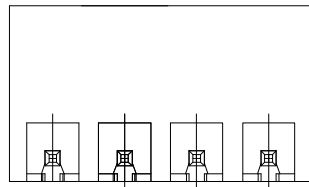
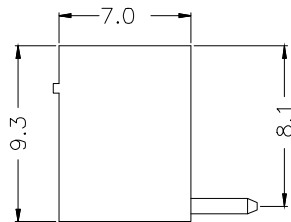
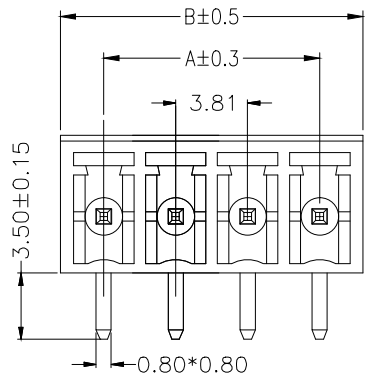

电气性能
 额定电压: 300V
 额定电流: 8A
 接触电阻: 20mΩ (Max)
 绝缘电阻: 500MΩ \DC1000V
 耐电压: AC1500V\1Min

机械性能
 温度范围: -40℃ ~ +105℃
 瞬时温度: +250℃ ,5秒

Circuits	Product name	Dimensino (mm)	
		A	B
2	2EDG-3.81-2AW	3.81	8.42
3	2EDG-3.81-3AW	7.62	12.23
4	2EDG-3.81-4AW	11.43	16.04
5	2EDG-3.81-5AW	15.24	19.85
6	2EDG-3.81-6AW	19.05	23.66
7	2EDG-3.81-7AW	22.86	27.47
8	2EDG-3.81-8AW	26.67	31.28
9	2EDG-3.81-9AW	30.48	35.09
10	2EDG-3.81-10AW	34.29	38.90
11	2EDG-3.81-11AW	38.10	42.71
12	2EDG-3.81-12AW	41.91	46.52
13	2EDG-3.81-13AW	45.72	50.33
14	2EDG-3.81-14AW	49.53	54.14
15	2EDG-3.81-15AW	53.34	57.95
~	~	~	~
24	2EDG-3.81-24AW	87.63	92.24

材料及电镀

- ①. 塑件主体: PA66, UL94V-0
- ②. 焊 针: 黄铜, 镀镍

			GENEERL TOLERANCE	制 图 DRAWING	ZHE JIANG DELI CONNECTORS CO., LTD			
			DIM TOL	审 核 CHECK			版 本 REV.	A
			X.X ±0.50	批 准 APPROVAL	产品名称 TITLE	2EDG-3.81-AW	版 本 REV.	A
1	初版发行		X.XX ±0.30	比 例 SCALE	产品料号 PART NO.		单 位 UNITS	mm
序号 No.	变更内容 MODIFY CONTENT	日期 MODIFY DATE	X.XXX ±0.10	投 影 Projection	材 料 MATERIAL		页 次 SHEET	1/1
			Angle ±3.0°					

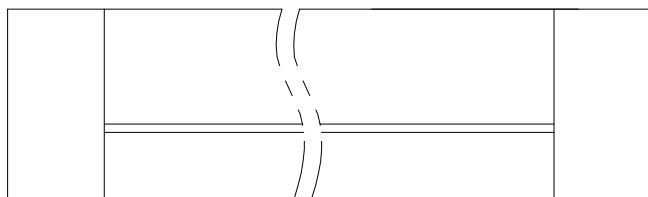

电气性能
 额定电压: 300V
 额定电流: 8A
 接触电阻: 20mΩ (Max)
 绝缘电阻: 500MΩ \ DC500V
 耐电压: AC1500V \ 1Min

机械性能
 温度范围: -40℃ ~ +105℃
 瞬时温度: +250℃ , 5秒

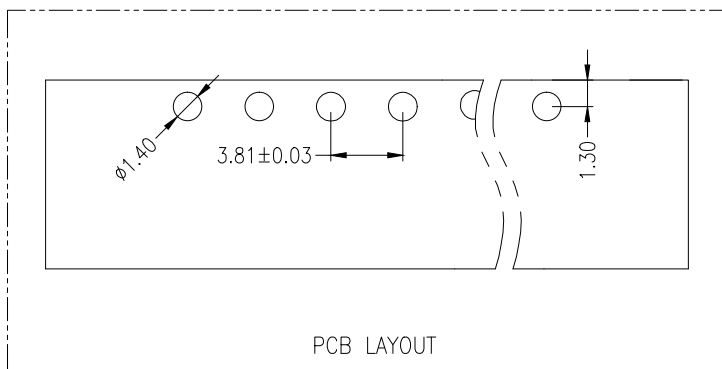
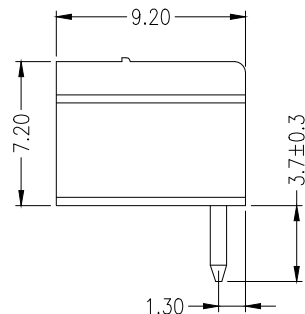
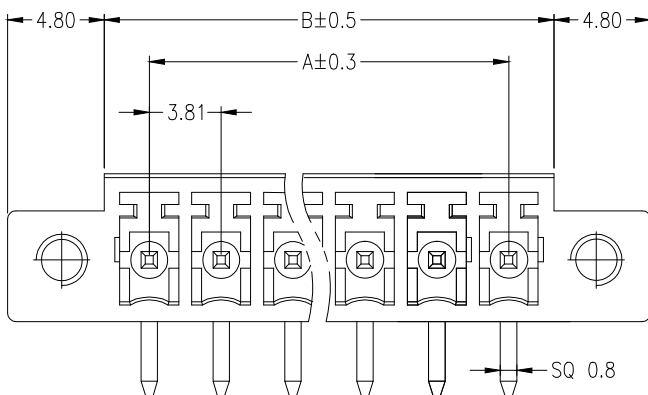
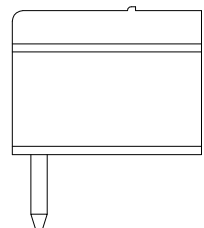

Circuits	Product name	Dimensino (mm)	
		A	B
2	2EDG-3.81-2AWLS	3.81	8.62
3	2EDG-3.81-3AWLS	7.62	12.43
4	2EDG-3.81-4AWLS	11.43	16.24
5	2EDG-3.81-5AWLS	15.24	20.05
6	2EDG-3.81-6AWLS	19.05	23.86
7	2EDG-3.81-7AWLS	22.86	27.67
8	2EDG-3.81-8AWLS	26.67	31.48
9	2EDG-3.81-9AWLS	30.48	35.29
10	2EDG-3.81-10AWLS	34.29	39.10
11	2EDG-3.81-11AWLS	38.10	42.91
12	2EDG-3.81-12AWLS	41.91	46.72
13	2EDG-3.81-13AWLS	45.72	50.53
14	2EDG-3.81-14AWLS	49.53	54.34
15	2EDG-3.81-15AWLS	53.34	58.15
~	~	~	~
24	2EDG-3.81-24AWLS	87.63	92.44

材料及电镀
 ①. 塑件主体: PA66, UL94V-0
 ②. 焊 针: 黄铜, 镀镍

			GENE RL TOLERANCE	制 图 DRAWING	ZHE JIANG DELI CONNECTORS CO ., LTD			
			DIM TOL	审 核 CHECK				
			X.X ±0.50	批 准 APPROVAL	产品名称 TITLE	2EDG-3.81-AWLS	版本 REV.	A
1	初版发行		X.XX ±0.30	比 例 SCALE	产品料号 PART NO.		单 位 UNITS	mm
序号 No.	变更内容 MODIFY CONTENT	日期 MODIFY DATE	X.XXX ±0.10	投 影 Projection	材 料 MATERIAL		页 次 SHEET	1/1
			Angle ±3.0°					

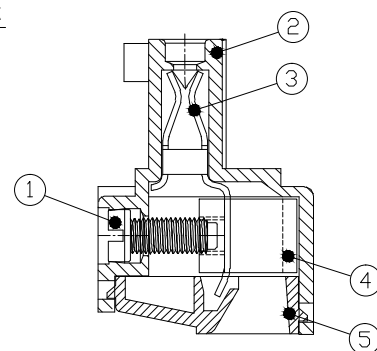
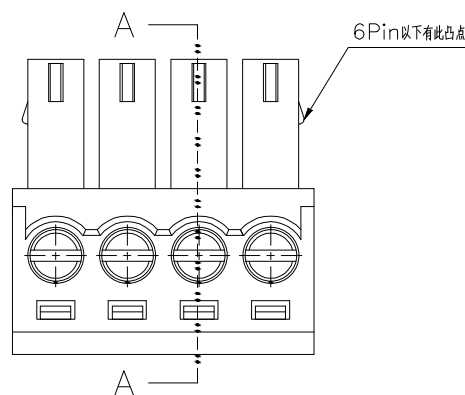
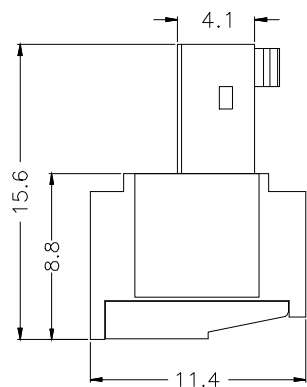
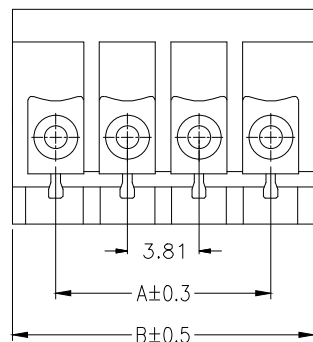

SECTION A-A

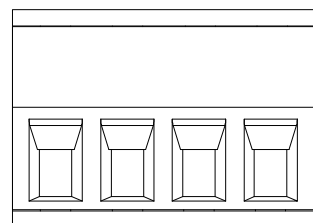

材料及电镀

- ①. 螺 丝: M2.0, 钢, 镀锌, 一字槽
- ②. 塑料主体: PA66, UL94V-0
- ③. 夹 子: 磷青铜, 镀镍
- ④. 方 盒: 黄铜, 镀镍
- ⑤. 塑料盖板: PA66, UL94V-0

电气性能
 额定电压: 300V
 额定电流: 8A
 接触电阻: 20mΩ (Max)
 绝缘电阻: 500MΩ \DC1000V
 耐 电 压: AC1500V\1Min
 使用线径: 24-14AWG 0.5-1.5mm²

机械性能
 温度范围: -40℃ ~ +105℃
 瞬时温度: +250℃ 5秒
 扭 力: 0.2N.m(1.77Lb. in)
 剥线长度: 6-7mm

Circuits	Product name	Dimensino (mm)	
		A	B
2	2EDG-3.81-2Y	3.81	8.42
3	2EDG-3.81-3Y	7.62	12.23
4	2EDG-3.81-4Y	11.43	16.04
5	2EDG-3.81-5Y	15.24	19.85
6	2EDG-3.81-6Y	19.05	23.66
7	2EDG-3.81-7Y	22.86	27.47
8	2EDG-3.81-8Y	26.67	31.28
9	2EDG-3.81-9Y	30.48	35.09
10	2EDG-3.81-10Y	34.29	38.90
11	2EDG-3.81-11Y	38.10	42.71
12	2EDG-3.81-12Y	41.91	46.52
13	2EDG-3.81-13Y	45.72	50.33
14	2EDG-3.81-14Y	49.53	54.14
15	2EDG-3.81-15Y	53.34	57.95
~	~	~	~
24	2EDG-3.81-24Y	87.63	92.24

			GENERL TOLERANCE		制 图 DRAWING		ZHE JIANG DELI CONNECTORS CO., LTD				
			DIM	TOL	审 核 CHECK						
			X.X	±0.50	批 准 APPROVAL		产品名称 TITLE	2EDG-3.81-Y		版本 REV.	A
			X.XX	±0.30	比 例 SCALE		产品料号 PART NO.			单 位 UNITS	mm
			X.XXX	±0.10	投 影 Projection		材 料 MATERIAL			页 次 SHEET	1/1
1	初版发行		Angle	±3.0°							
序号 No.	变更内容 MODIFY CONTENT	日期 MODIFY DATE									

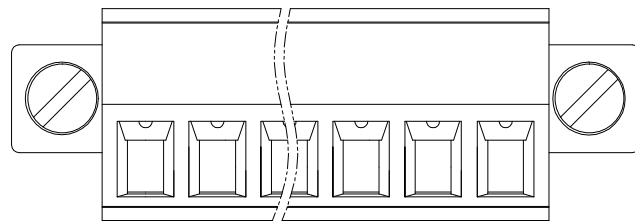
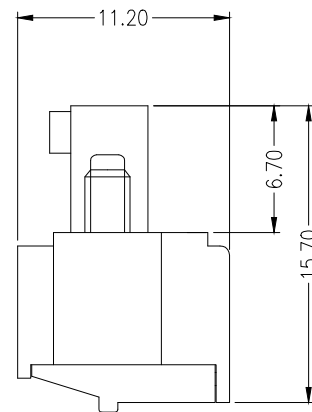
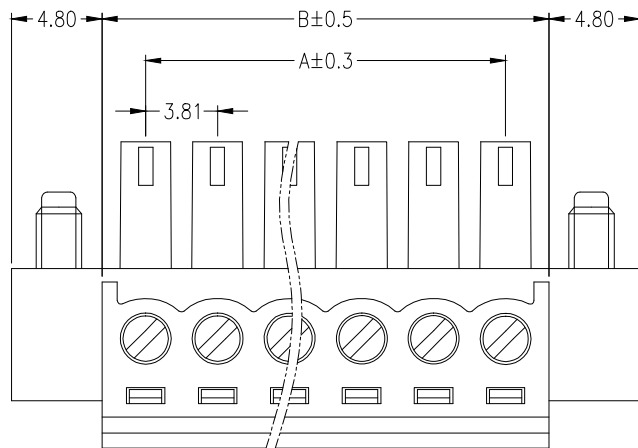
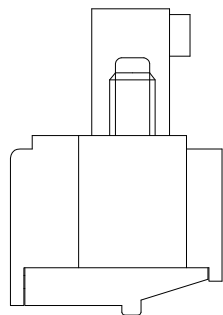

电气性能
 额定电压: 300V
 额定电流: 8A
 接触电阻: 20mΩ (Max)
 绝缘电阻: 500MΩ \DC500V
 耐电压: AC1500V\1Min
 使用线径: 28-16AWG 1.5mm²

机械性能
 温度范围: -40℃ ~ +105℃
 瞬时温度: +250℃ 5秒
 扭 力: 0.2Nm (1.77lbin)
 剥线长度: 6-7mm

材料及电镀

- ①. 塑件主体: PA66, UL94V-0
- ②. 夹 子: 磷青铜, 镀镍
- ③. 方 盒: 黄铜, 镀镍
- ④. 塑件盖板: PA66, UL94V-0
- ⑤. 螺 丝: M2.0, 钢, 镀锌, 一字槽

Circuits	Product name	Dimensino (mm)	
		A	B
2	2EDG-3.81-2YLS	3.81	8.62
3	2EDG-3.81-3YLS	7.62	12.43
4	2EDG-3.81-4YLS	11.43	16.24
5	2EDG-3.81-5YLS	15.24	20.05
6	2EDG-3.81-6YLS	19.05	23.86
7	2EDG-3.81-7YLS	22.86	27.67
8	2EDG-3.81-8YLS	26.67	31.48
9	2EDG-3.81-9YLS	30.48	35.29
10	2EDG-3.81-10YLS	34.29	39.10
11	2EDG-3.81-11YLS	38.10	42.91
12	2EDG-3.81-12YLS	41.91	46.72
13	2EDG-3.81-13YLS	45.72	50.53
14	2EDG-3.81-14YLS	49.53	54.34
15	2EDG-3.81-15YLS	53.34	58.15
~	~	~	~
24	2EDG-3.81-24YLS	87.63	92.44

			GENEAL TOLERANCE		制 图 DRAWING		ZHE JIANG DELI CONNECTORS CO., LTD				
			DIM	TOL	审 核 CHECK						
			X.X	±0.50	批 准 APPROVAL		产品名称 TITLE	2EDG-3.81-YLS		版本 REV.	A
			X.XX	±0.30	比 例 SCALE		产品料号 PART NO.			单 位 UNITS	mm
			X.XXX	±0.10	投 影 Projection		材 料 MATERIAL			页 次 SHEET	1/1
1	初版发行		Angle	±3.0°							
序号 No.	变更内容 MODIFY CONTENT	日期 MODIFY DATE									

X-ON Electronics

Largest Supplier of Electrical and Electronic Components

Click to view similar products for [Pluggable Terminal Blocks](#) category:

Click to view products by [DLL](#) manufacturer:

Other Similar products are found below :

[57.510.0053](#) [721-104/026-047](#) [721-204/026-045](#) [MC 1.5/ 6-ST-3.5 GY AU](#) [ET02015000J0G](#) [860505](#) [860516](#) [860810](#) [GBPACX-12](#)
[93.731.4953.0](#) [PVP03-3,50](#) [PVS02-5,00](#) [1-1986160-3](#) [1377680000](#) [1531000000](#) [1546228-5](#) [ELFP03110](#) [ELFP10210](#) [ELFT07250](#)
[ELVD12100](#) [ELVF09400](#) [ELXH071G0E](#) [1725220000](#) [1760336](#) [1855000000](#) [19346](#) [1946309](#) [1973592](#) [19892](#) [25.320.4053.1](#) [25.320.4553.9](#)
[25.320.4753.1](#) [25.320.5453.1](#) [25.340.0353.1](#) [25.340.1053.1](#) [25.345.3553.0M001](#) [25.640.3553.1](#) [SH02-5,08](#) [SH06-3,81](#) [SH08-5,08](#) [SH08-](#)
[5,08-K](#) [SH12-5,08](#) [SHS04-5,00](#) [30.303](#) [30.305](#) [30.306](#) [PHP09-5,08](#) [25.193.0453.0](#) [25.320.4653.1](#) [25.332.2453.1](#)