

技术特性/Specifications:

额定电压 Rated voltage: 300V AC, DC
额定电流 Rated current: 18A AC, DC
接触电阻 Contact resistance: 20mΩ max
绝缘电阻 Insulation resistance: 500MΩ min
耐压 Withstand voltage: 2000V AC/minute
环境温度 Ambient temperature: -40℃~+105℃
适用线规 Wire range: AWG#28~#14

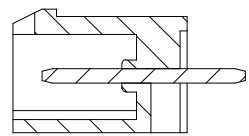

SECTION A-A

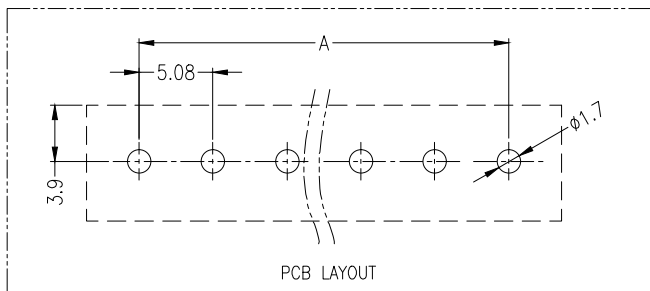
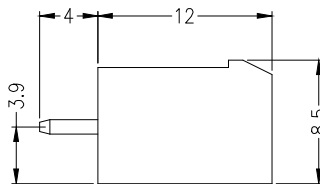
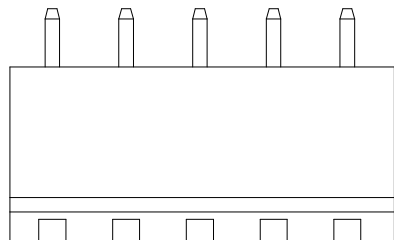
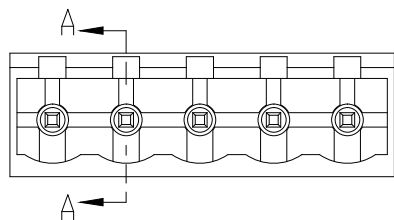
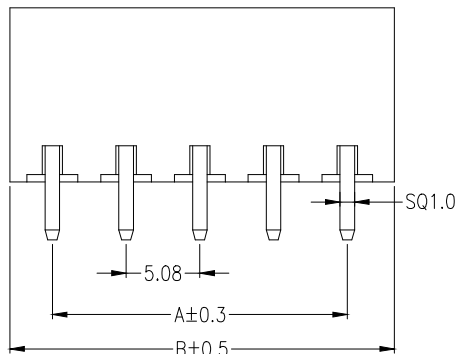

PCB LAYOUT

材料及电镀

- ①. 塑件主体: PA66, UL94V-0
- ②. 焊 针: 黄铜, 镀镍

电气性能

- 额定电压: 300V
- 额定电流: 15A
- 接触电阻: 20mΩ (Max)
- 绝缘电阻: 500MΩ DC500V
- 耐 电 压: AC2000V\1Min

机械性能

- 温度范围: -40℃ ~ +105℃
- 瞬时温度: +250℃ ,5秒

| Circuits | Product name | Dimensino (mm) | |
|----------|---------------|----------------|--------|
| | | A | B |
| 2 | 2EDG-5.08-2A | 5.08 | 10.96 |
| 3 | 2EDG-5.08-3A | 10.16 | 16.04 |
| 4 | 2EDG-5.08-4A | 15.24 | 21.12 |
| 5 | 2EDG-5.08-5A | 20.32 | 26.20 |
| 6 | 2EDG-5.08-6A | 25.40 | 31.28 |
| 7 | 2EDG-5.08-7A | 30.48 | 36.36 |
| 8 | 2EDG-5.08-8A | 35.56 | 41.44 |
| 9 | 2EDG-5.08-9A | 40.64 | 46.52 |
| 10 | 2EDG-5.08-10A | 45.72 | 51.60 |
| 11 | 2EDG-5.08-11A | 50.80 | 56.68 |
| 12 | 2EDG-5.08-12A | 55.88 | 61.76 |
| 13 | 2EDG-5.08-13A | 60.96 | 66.84 |
| 14 | 2EDG-5.08-14A | 66.04 | 71.92 |
| 15 | 2EDG-5.08-15A | 71.12 | 77.00 |
| ~ | ~ | ~ | ~ |
| 24 | 2EDG-5.08-24A | 116.84 | 122.72 |

| | | | GENE RL TOLERANCE | 制 图 DRAWING | ZHE JIANG DELI CONNECTORS CO ., LTD | | | | |
|-----------|------------------------|-------------------|-------------------|----------------|-------------------------------------|------------------|-------------|--------------|-----|
| | | | DIM | TOL | 审 核 CHECK | | | | |
| | | | X. X | ±0.50 | 批 准 APPROVAL | 产品名称 TITLE | 2EDG-5.08-A | 版本 REV. | A |
| 1 | 初版发行 | | X. XX | ±0.30 | 比 例 SCALE | 产品料号 PART NO. | | 单 位 UNITS | mm |
| 序号 No. | 变更内容 MODIFY CONTENT | 日期 MODIFY DATE | X. XXX | ±0.10 | 投 影 Projection | 材 料 MATERIAL | | 页 次 SHEET | 1/1 |
| | | | Angle | ±3.0° | | | | | |

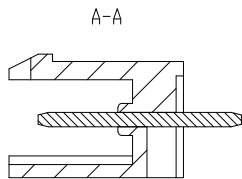
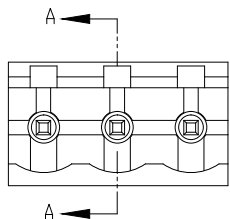
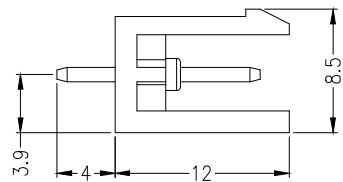

SECTION A-A

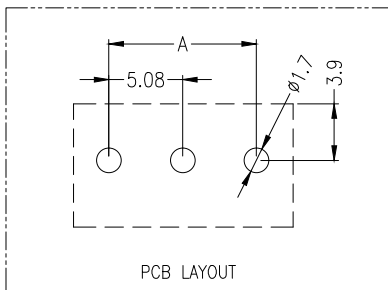
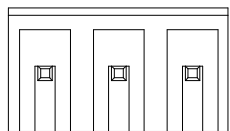
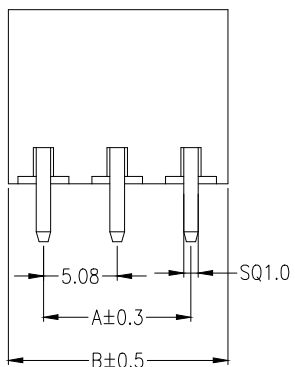

材料及电镀

- ①. 塑件主体: PA66, UL94V-0
- ②. 焊 针: 黄铜, 镀镍

电气性能

- 额定电压: 300V
- 额定电流: 15A
- 接触电阻: 20mΩ (Max)
- 绝缘电阻: 500MΩ \DC500V
- 耐 电 压: AC2000V\1Min

机械性能

- 温度范围: -40℃ ~ +105℃
- 瞬时温度: +250℃ ,5秒

| Circuits | Product name | Dimensino(mm) | |
|----------|----------------|---------------|--------|
| | | A | B |
| 2 | 2EDG-5.08-2AH | 5.08 | 10.16 |
| 3 | 2EDG-5.08-3AH | 10.16 | 15.24 |
| 4 | 2EDG-5.08-4AH | 15.24 | 20.32 |
| 5 | 2EDG-5.08-5AH | 20.32 | 25.40 |
| 6 | 2EDG-5.08-6AH | 25.40 | 30.48 |
| 7 | 2EDG-5.08-7AH | 30.48 | 35.56 |
| 8 | 2EDG-5.08-8AH | 35.56 | 40.64 |
| 9 | 2EDG-5.08-9AH | 40.64 | 45.72 |
| 10 | 2EDG-5.08-10AH | 45.72 | 50.80 |
| 11 | 2EDG-5.08-11AH | 50.80 | 55.88 |
| 12 | 2EDG-5.08-12AH | 55.88 | 60.96 |
| 13 | 2EDG-5.08-13AH | 60.96 | 66.04 |
| 14 | 2EDG-5.08-14AH | 66.04 | 71.12 |
| 15 | 2EDG-5.08-15AH | 71.12 | 76.20 |
| ~ | ~ | ~ | ~ |
| 24 | 2EDG-5.08-24AH | 116.84 | 121.92 |

| | | | | | | | | |
|-----------|------------------------|-------------------|-------------------|-------------------|-----------------------------------|--------------|--------------|-----|
| | | | GENEERL TOLERANCE | 制 图 DRAWING | ZHE JIANG DELI CONNECTORS CO.,LTD | | | |
| | | | DIM TOL | 审 核 CHECK | | | | |
| | | | X.X ±0.50 | 批 准 APPROVAL | 产品名称 TITLE | 2EDG-5.08-AH | 版本 REV. | A |
| 1 | 初版发行 | | X.XX ±0.30 | 比 例 SCALE | 产品料号 PART NO. | | 单 位 UNITS | mm |
| 序号 No. | 变更内容 MODIFY CONTENT | 日期 MODIFY DATE | X.XXX ±0.10 | 投 影 Projection | 材 料 MATERIAL | | 页 次 SHEET | 1/1 |
| | | | Angle ±3.0° | | | | | |

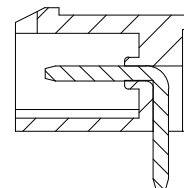
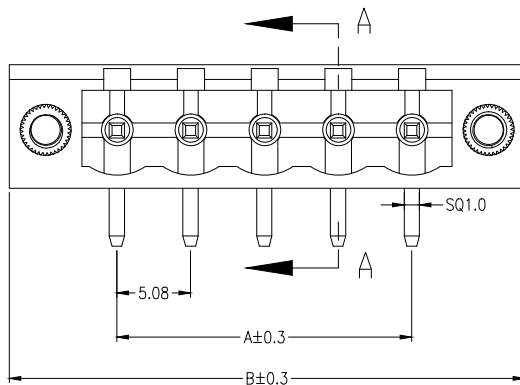
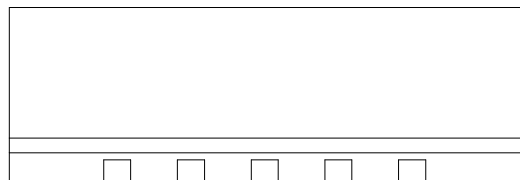
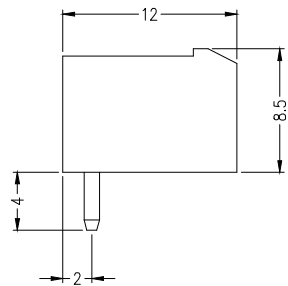

SECTION A-A

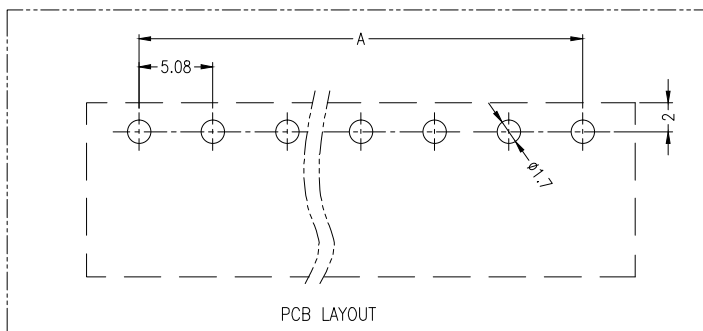
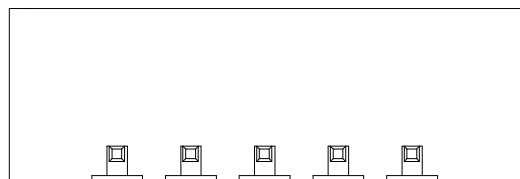

材料及电镀

- ①. 塑件主体: PA66, UL94V-0
- ②. 焊 针: 黄铜, 镀镍

电气性能

- 额定电压: 300V
- 额定电流: 15A
- 接触电阻: 20mΩ (Max)
- 绝缘电阻: 500MΩ \DC500V
- 耐 电 压: AC2000V\1Min

机械性能

- 温度范围: -40℃ ~ +105℃
- 瞬时温度: +250℃ ,5秒

| Circuits | Product name | Dimensino (mm) | |
|----------|------------------|----------------|--------|
| | | A | B |
| 2 | 2EDG-5.08-2AWLS | 5.08 | 11.16 |
| 3 | 2EDG-5.08-3AWLS | 10.16 | 16.24 |
| 4 | 2EDG-5.08-4AWLS | 15.24 | 21.32 |
| 5 | 2EDG-5.08-5AWLS | 20.32 | 26.40 |
| 6 | 2EDG-5.08-6AWLS | 25.40 | 31.48 |
| 7 | 2EDG-5.08-7AWLS | 30.48 | 36.56 |
| 8 | 2EDG-5.08-8AWLS | 35.56 | 41.64 |
| 9 | 2EDG-5.08-9AWLS | 40.64 | 46.72 |
| 10 | 2EDG-5.08-10AWLS | 45.72 | 51.80 |
| 11 | 2EDG-5.08-11AWLS | 50.80 | 56.88 |
| 12 | 2EDG-5.08-12AWLS | 55.88 | 61.96 |
| 13 | 2EDG-5.08-13AWLS | 60.96 | 67.04 |
| 14 | 2EDG-5.08-14AWLS | 66.04 | 72.12 |
| 15 | 2EDG-5.08-15AWLS | 71.12 | 77.20 |
| ~ | ~ | ~ | ~ |
| 24 | 2EDG-5.08-24AWLS | 116.84 | 122.92 |

| | | | | | | | | |
|-----------|------------------------|-------------------|-------------------|-------------------|-------------------------------------|----------------|--------------|-----|
| | | | GENEERL TOLERANCE | 制 图 DRAWING | ZHE JIANG DELI CONNECTORS CO ., LTD | | | |
| | | | DIM TOL | 审 核 CHECK | | | | |
| | | | X.X ±0.50 | 批 准 APPROVAL | 产品名称 TITLE | 2EDG-5.08-AWLS | 版本 REV. | A |
| 1 | 初版发行 | | X.XX ±0.30 | 比 例 SCALE | 产品料号 PART NO. | | 单 位 UNITS | mm |
| 序号 No. | 变更内容 MODIFY CONTENT | 日期 MODIFY DATE | X.XXX ±0.10 | 投 影 Projection | 材 料 MATERIAL | | 页 次 SHEET | 1/1 |
| | | | Angle ±3.0° | | | | | |

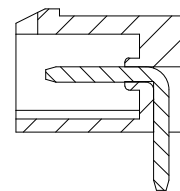
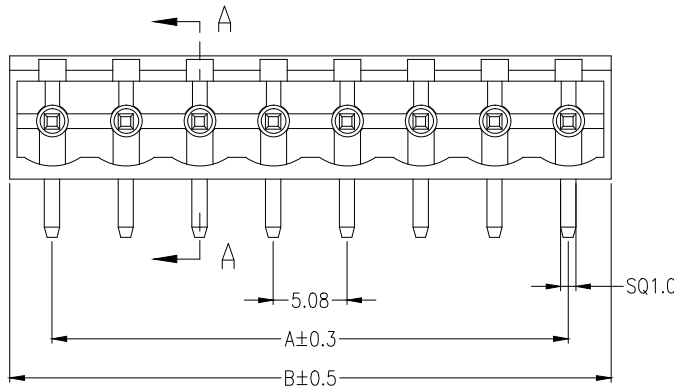
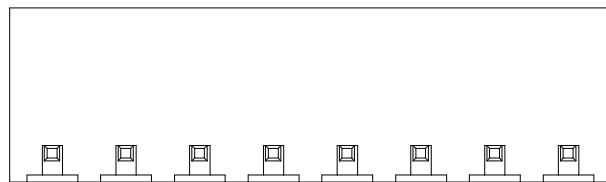
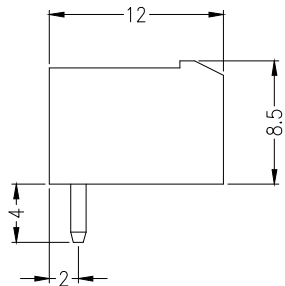

SECTION A-A

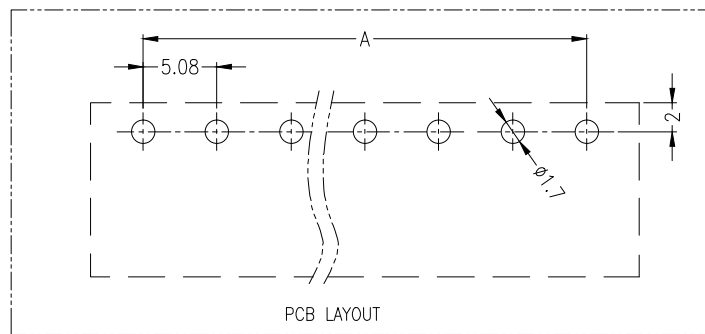
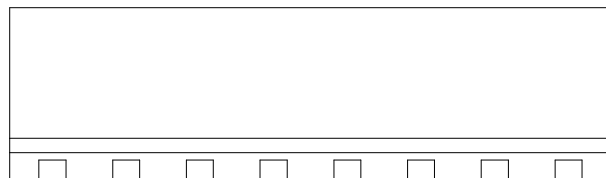

材料及电镀
 ①. 塑件主体: PA66, UL94V-0
 ②. 焊 针: 黄铜, 镀镍

电气性能
 额定电压: 300V
 额定电流: 15A
 接触电阻: 20mΩ (Max)
 绝缘电阻: 500MΩ \DC500V
 耐 电 压: AC2000V\1Min

机械性能
 温度范围: -40℃ ~ +105℃
 瞬时温度: +250℃ ,5秒

| Circuits | Product name | Dimensino (mm) | |
|----------|----------------|----------------|--------|
| | | A | B |
| 2 | 2EDG-5.08-2AW | 5.08 | 10.96 |
| 3 | 2EDG-5.08-3AW | 10.16 | 16.04 |
| 4 | 2EDG-5.08-4AW | 15.24 | 21.12 |
| 5 | 2EDG-5.08-5AW | 20.32 | 26.20 |
| 6 | 2EDG-5.08-6AW | 25.40 | 31.28 |
| 7 | 2EDG-5.08-7AW | 30.48 | 36.36 |
| 8 | 2EDG-5.08-8AW | 35.56 | 41.44 |
| 9 | 2EDG-5.08-9AW | 40.64 | 46.52 |
| 10 | 2EDG-5.08-10AW | 45.72 | 51.60 |
| 11 | 2EDG-5.08-11AW | 50.80 | 56.68 |
| 12 | 2EDG-5.08-12AW | 55.88 | 61.76 |
| 13 | 2EDG-5.08-13AW | 60.96 | 66.84 |
| 14 | 2EDG-5.08-14AW | 66.04 | 71.92 |
| 15 | 2EDG-5.08-15AW | 71.12 | 77.00 |
| ~ | ~ | ~ | ~ |
| 24 | 2EDG-5.08-24AW | 116.84 | 122.72 |

| | | | | | | | | |
|-----------|------------------------|-------------------|-------------------|-------------------|------------------------------------|--------------|--------------|-----|
| | | | GENEERL TOLERANCE | 制 图 DRAWING | ZHE JIANG DELI CONNECTORS CO., LTD | | | |
| | | | DIM TOL | 审 核 CHECK | | | | |
| | | | X.X ±0.50 | 批 准 APPROVAL | 产品名称 TITLE | 2EDG-5.08-AW | 版 本 REV. | A |
| | | | X.XX ±0.30 | 比 例 SCALE | 产品料号 PART NO. | | 单 位 UNITS | mm |
| 1 | 初版发行 | | X.XXX ±0.10 | 投 影 Projection | 材 料 MATERIAL | | 页 次 SHEET | 1/1 |
| 序号 No. | 变更内容 MODIFY CONTENT | 日期 MODIFY DATE | Angle ±3.0° | | | | | |

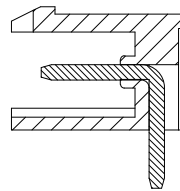
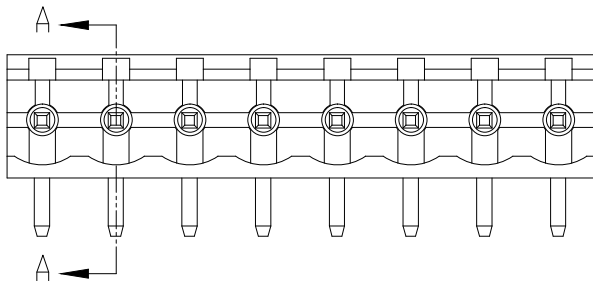
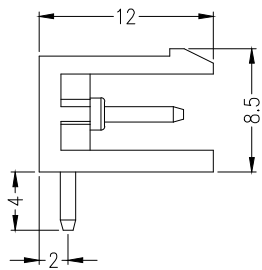

SECTION A-A

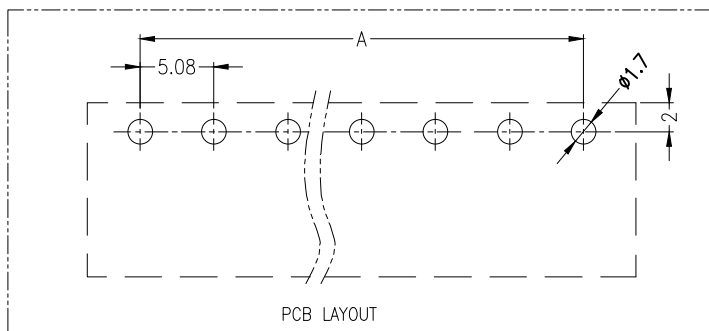
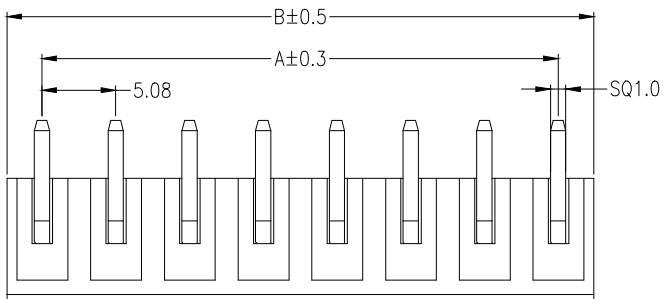
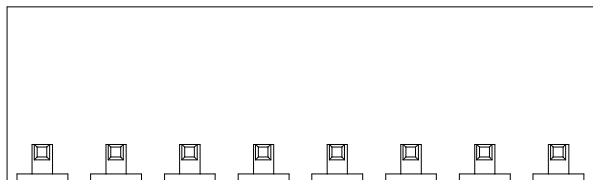

电气性能
 额定电压: 300V
 额定电流: 15A
 接触电阻: 20mΩ (Max)
 绝缘电阻: 500MΩ \DC500V
 耐电压: AC2000V\1Min

机械性能
 温度范围: -40℃ ~ +105℃
 瞬时温度: +250℃ ,5秒

材料及电镀
 ①. 塑件主体: PA66, UL94V-0
 ②. 焊 针: 黄铜, 镀镍

| Circuits | Product name | Dimensino (mm) | |
|----------|-----------------|----------------|--------|
| | | A | B |
| 2 | 2EDG-5.08-2AWH | 5.08 | 10.16 |
| 3 | 2EDG-5.08-3AWH | 10.16 | 15.24 |
| 4 | 2EDG-5.08-4AWH | 15.24 | 20.32 |
| 5 | 2EDG-5.08-5AWH | 20.32 | 25.40 |
| 6 | 2EDG-5.08-6AWH | 25.40 | 30.48 |
| 7 | 2EDG-5.08-7AWH | 30.48 | 35.56 |
| 8 | 2EDG-5.08-8AWH | 35.56 | 40.64 |
| 9 | 2EDG-5.08-9AWH | 40.64 | 45.72 |
| 10 | 2EDG-5.08-10AWH | 45.72 | 50.80 |
| 11 | 2EDG-5.08-11AWH | 50.80 | 55.88 |
| 12 | 2EDG-5.08-12AWH | 55.88 | 60.96 |
| 13 | 2EDG-5.08-13AWH | 60.96 | 66.04 |
| 14 | 2EDG-5.08-14AWH | 66.04 | 71.12 |
| 15 | 2EDG-5.08-15AWH | 71.12 | 76.20 |
| ~ | ~ | ~ | ~ |
| 24 | 2EDG-5.08-24AWH | 116.84 | 121.92 |

| | | | | | | | | |
|-----------|------------------------|-------------------|------------------|------------------|-----------------------------------|---------------|-------------|-----|
| | | | GENEAL TOLERANCE | 制图 DRAWING | ZHE JIANG DELI CONNECTORS CO.,LTD | | | |
| | | | DIM TOL | 审核 CHECK | | | | |
| | | | X.X ±0.50 | 批准 APPROVAL | 产品名称 TITLE | 2EDG-5.08-AWH | 版本 REV. | A |
| 1 | 初版发行 | | X.XX ±0.30 | 比例 SCALE | 产品料号 PART NO. | | 单位 UNITS | mm |
| 序号 No. | 变更内容 MODIFY CONTENT | 日期 MODIFY DATE | X.XXX ±0.10 | 投影 Projection | 材料 MATERIAL | | 页次 SHEET | 1/1 |
| | | | Angle ±3.0° | | | | | |

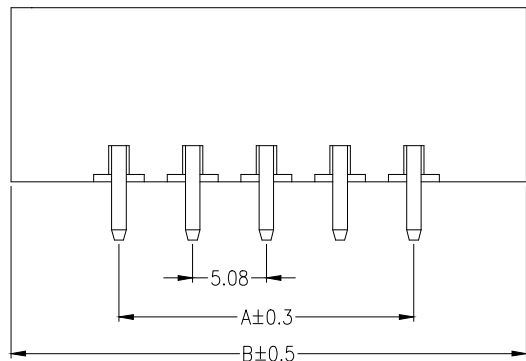

材料及电镀
 ① 塑件主体: PA66, UL94V-0
 ② 焊 针: 黄铜, 镀镍

电气性能
 额定电压: 300V
 额定电流: 15A
 接触电阻: 20mΩ (Max)
 绝缘电阻: 500MΩ \DC500V
 耐 电 压: AC2000V\1min

机械性能
 温度范围: -40℃ ~ +105℃
 瞬时温度: +250℃ ,5秒

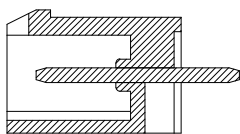

SECTION A-A

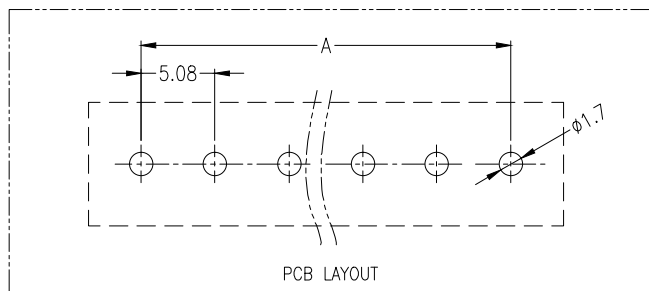
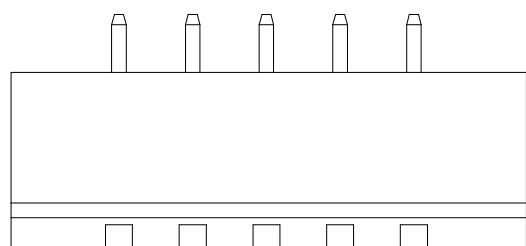
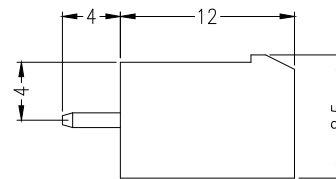
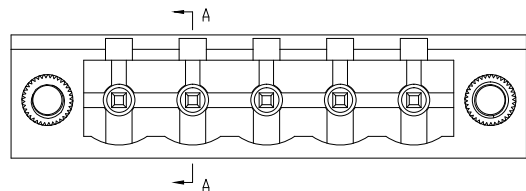

PCB LAYOUT

| Circuits | Product name | Dimensino (mm) | |
|----------|-----------------|----------------|--------|
| | | A | B |
| 2 | 2EDG-5.08-2ALS | 5.08 | 10.96 |
| 3 | 2EDG-5.08-3ALS | 10.16 | 16.04 |
| 4 | 2EDG-5.08-4ALS | 15.24 | 21.12 |
| 5 | 2EDG-5.08-5ALS | 20.32 | 26.20 |
| 6 | 2EDG-5.08-6ALS | 25.40 | 31.28 |
| 7 | 2EDG-5.08-7ALS | 30.48 | 36.36 |
| 8 | 2EDG-5.08-8ALS | 35.56 | 41.44 |
| 9 | 2EDG-5.08-9ALS | 40.64 | 46.52 |
| 10 | 2EDG-5.08-10ALS | 45.72 | 51.60 |
| 11 | 2EDG-5.08-11ALS | 50.80 | 56.68 |
| 12 | 2EDG-5.08-12ALS | 55.88 | 61.76 |
| 13 | 2EDG-5.08-13ALS | 60.96 | 66.84 |
| 14 | 2EDG-5.08-14ALS | 66.04 | 71.92 |
| 15 | 2EDG-5.08-15ALS | 71.12 | 77.00 |
| ~ | ~ | ~ | ~ |
| 24 | 2EDG-5.08-24ALS | 116.84 | 122.72 |

| | | | GENE RL TOLERANCE | 制 图 DRAWING | ZHE JIANG DELI CONNECTORS CO ., LTD | | | |
|-----------|---------------------------|--------------------|-------------------|-------------------|-------------------------------------|---------------|--------------|-----|
| | | | DIM TOL | 审 核 CHECK | | | 版 本 REV. | A |
| | | | X.X ±0.50 | 批 准 APPROVAL | 产 品 名 称 TITLE | 2EDG-5.08-ALS | 单 位 UNITS | mm |
| 1 | 初版发行 | | X.XX ±0.30 | 比 例 SCALE | 产 品 料 号 PART NO. | | 页 次 SHEET | 1/1 |
| 序号 No. | 变 更 内 容 MODIFY CONTENT | 日 期 MODIFY DATE | X.XXX ±0.10 | 投 影 Projection | 材 料 MATERIAL | | | |
| | | | Angle ±3.0° | | | | | |

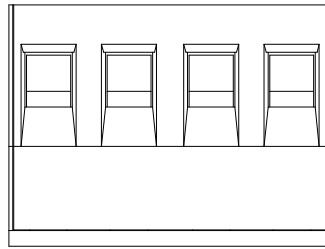

材料及电镀

- ①. 螺 丝: M2.5, 钢, 镀锌, 一字槽
- ②. 塑件主体: PA66, UL94V-0
- ③. 夹 子: 磷青铜, 镀镍
- ④. 方 盒: 黄铜, 镀镍
- ⑤. 塑件盖板: PA66, UL94V-0

电气性能

- 额定电压: 300V
- 额定电流: 15A
- 接触电阻: 20mΩ (Max)
- 绝缘电阻: 500MΩ \DC500V
- 耐 电 压: AC2000V\1min
- 使用线径: 28-14AWG 2.5mm²

机械性能

- 温度范围: -40℃ ~ +105℃
- 瞬时温度: +250℃ 5秒
- 扭 力: 0.5Nm (4.43Lbin)
- 剥线长度: 7-8mm

3 Pin以上

2 Pin

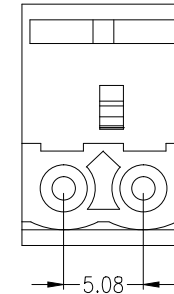
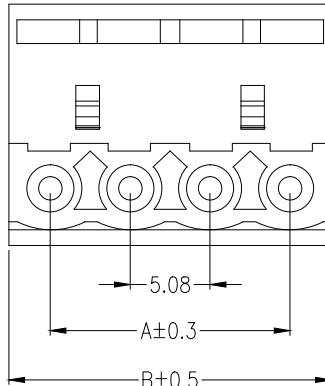
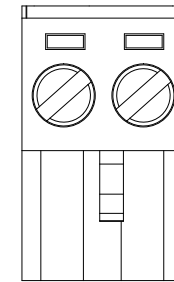
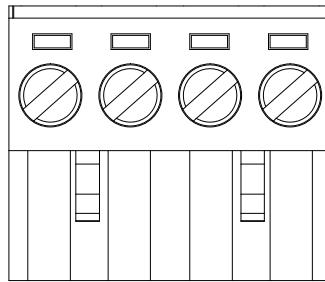
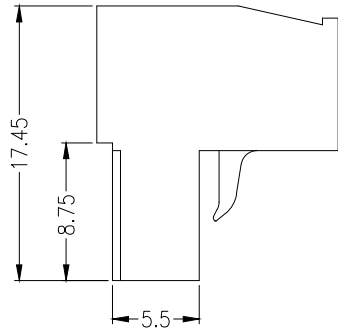

| Circuits | Product name | Dimensino (mm) | |
|----------|---------------|----------------|--------|
| | | A | B |
| 2 | 2EDG-5.08-2Y | 5.08 | 10.96 |
| 3 | 2EDG-5.08-3Y | 10.16 | 16.04 |
| 4 | 2EDG-5.08-4Y | 15.24 | 21.12 |
| 5 | 2EDG-5.08-5Y | 20.32 | 26.20 |
| 6 | 2EDG-5.08-6Y | 25.40 | 31.28 |
| 7 | 2EDG-5.08-7Y | 30.48 | 36.36 |
| 8 | 2EDG-5.08-8Y | 35.56 | 41.44 |
| 9 | 2EDG-5.08-9Y | 40.64 | 46.52 |
| 10 | 2EDG-5.08-10Y | 45.72 | 51.60 |
| 11 | 2EDG-5.08-11Y | 50.80 | 56.68 |
| 12 | 2EDG-5.08-12Y | 55.88 | 61.76 |
| 13 | 2EDG-5.08-13Y | 60.96 | 66.84 |
| 14 | 2EDG-5.08-14Y | 66.04 | 71.92 |
| 15 | 2EDG-5.08-15Y | 71.12 | 77.00 |
| ~ | ~ | ~ | ~ |
| 24 | 2EDG-5.08-24Y | 116.84 | 122.72 |

| | | | | | | | | | | | |
|-----------|------------------------|-------------------|-------------------|-------|-------------------|--|------------------------------------|-------------|--|--------------|-----|
| | | | GENEERL TOLERANCE | | 制 图 DRAWING | | ZHE JIANG DELI CONNECTORS CO., LTD | | | | |
| | | | DIM | TOL | 审 核 CHECK | | | | | | |
| | | | X.X | ±0.50 | 批 准 APPROVAL | | 产品名称 TITLE | 2EDG-5.08-Y | | 版本 REV. | A |
| | | | X.XX | ±0.30 | 比 例 SCALE | | 产品料号 PART NO. | | | 单 位 UNITS | mm |
| | | | X.XXX | ±0.10 | 投 影 Projection | | 材 料 MATERIAL | | | 页 次 SHEET | 1/1 |
| | | | Angle | ±3.0° | | | | | | | |
| 1 | 初版发行 | | | | | | | | | | |
| 序号 No. | 变更内容 MODIFY CONTENT | 日期 MODIFY DATE | | | | | | | | | |

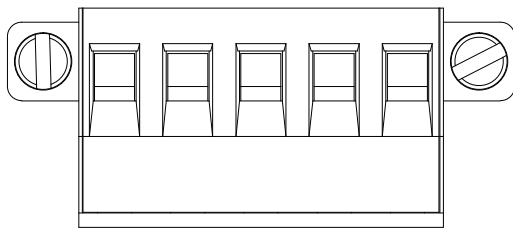

材料及电镀

- ①. 螺 丝: M2.5, 钢, 镀锌, 一字槽
- ②. 塑件主体: PA66, UL94V-0
- ③. 夹 子: 磷青铜, 镀镍
- ④. 方 盒: 黄铜, 镀镍
- ⑤. 塑件盖板: PA66, UL94V-0

电气性能
 额定电压: 300V
 额定电流: 15A
 接触电阻: 20mΩ (Max)
 绝缘电阻: 500MΩ \DC500V
 耐 电 压: AC2000V\1Min
 使用线径: 28-14AWG 2.5mm²

3 Pin以上

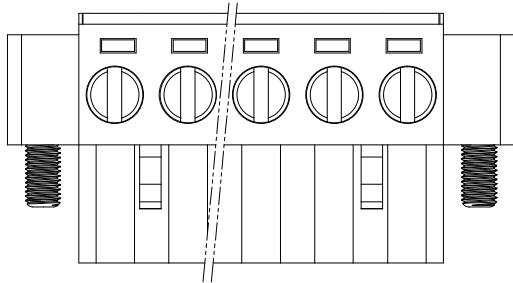

2 Pin

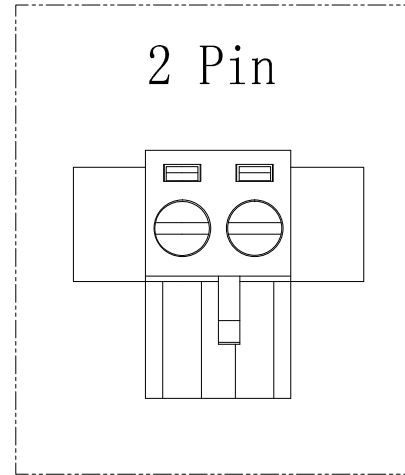

机械性能
 温度范围: -40℃ ~ +105℃
 瞬时温度: +250℃ 5秒
 扭 力: 0.5Nm(4.43Lbin)
 剥线长度: 7-8mm

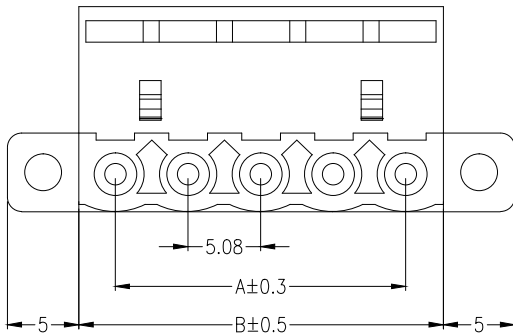
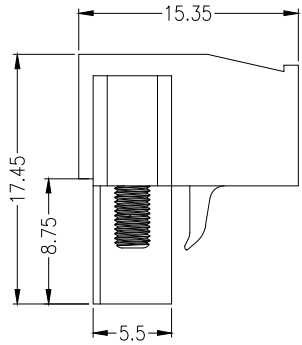

| Circuits | Product name | Dimensino (mm) | |
|----------|-----------------|----------------|--------|
| | | A | B |
| 2 | 2EDG-5.08-2YLS | 5.08 | 11.16 |
| 3 | 2EDG-5.08-3YLS | 10.16 | 16.24 |
| 4 | 2EDG-5.08-4YLS | 15.24 | 21.32 |
| 5 | 2EDG-5.08-5YLS | 20.32 | 26.40 |
| 6 | 2EDG-5.08-6YLS | 25.40 | 31.48 |
| 7 | 2EDG-5.08-7YLS | 30.48 | 36.56 |
| 8 | 2EDG-5.08-8YLS | 35.56 | 41.64 |
| 9 | 2EDG-5.08-9YLS | 40.64 | 46.72 |
| 10 | 2EDG-5.08-10YLS | 45.72 | 51.80 |
| 11 | 2EDG-5.08-11YLS | 50.80 | 56.88 |
| 12 | 2EDG-5.08-12YLS | 55.88 | 61.96 |
| 13 | 2EDG-5.08-13YLS | 60.96 | 67.04 |
| 14 | 2EDG-5.08-14YLS | 66.04 | 72.12 |
| 15 | 2EDG-5.08-15YLS | 71.12 | 77.20 |
| ~ | ~ | ~ | ~ |
| 24 | 2EDG-5.08-24YLS | 116.84 | 122.92 |

| | | | | | | | | | | | |
|-----------|------------------------|-------------------|------------------|-------|-------------------|--|------------------------------------|---------------|--|--------------|-----|
| | | | GENEAL TOLERANCE | | 制 图 DRAWING | | ZHE JIANG DELI CONNECTORS CO., LTD | | | | |
| | | | DIM | TOL | 审 核 CHECK | | | | | | |
| | | | X.X | ±0.50 | 批 准 APPROVAL | | 产品名称 TITLE | 2EDG-5.08-YLS | | 版本 REV. | A |
| 1 | | | 初版发行 | | 比 例 SCALE | | 产品料号 PART NO. | | | 单 位 UNITS | mm |
| 序号 No. | 变更内容 MODIFY CONTENT | 日期 MODIFY DATE | Angle ±3.0° | | 投 影 Projection | | 材 料 MATERIAL | | | 页 次 SHEET | 1/1 |

X-ON Electronics

Largest Supplier of Electrical and Electronic Components

Click to view similar products for [Pluggable Terminal Blocks](#) category:

Click to view products by [DLL](#) manufacturer:

Other Similar products are found below :

[57.510.0053](#) [721-104/026-047](#) [721-204/026-045](#) [MC 1.5/ 6-ST-3.5 GY AU](#) [ET02015000J0G](#) [860505](#) [860516](#) [860810](#) [GBPACX-12](#)
[93.731.4953.0](#) [PVP03-3,50](#) [PVS02-5,00](#) [1-1986160-3](#) [1377680000](#) [1531000000](#) [1546228-5](#) [ELFP03110](#) [ELFP10210](#) [ELFT07250](#)
[ELVD12100](#) [ELVF09400](#) [ELXH071G0E](#) [1725220000](#) [1760336](#) [1855000000](#) [19346](#) [1946309](#) [1973592](#) [19892](#) [25.320.4053.1](#) [25.320.4553.9](#)
[25.320.4753.1](#) [25.320.5453.1](#) [25.340.0353.1](#) [25.340.1053.1](#) [25.345.3553.0M001](#) [25.640.3553.1](#) [SH02-5,08](#) [SH06-3,81](#) [SH08-5,08](#) [SH08-](#)
[5,08-K](#) [SH12-5,08](#) [SHS04-5,00](#) [30.303](#) [30.305](#) [30.306](#) [PHP09-5,08](#) [25.193.0453.0](#) [25.320.4653.1](#) [25.332.2453.1](#)