

技术特性/Specifications:

额定电压 Rated voltage: 300V AC, DC
额定电流 Rated current: 18A AC, DC
接触电阻 Contact resistance: 20mΩ max
绝缘电阻 Insulation resistance: 500MΩ min
耐压 Withstand voltage: 2000V AC/minute
环境温度 Ambient temperature: -40°C~+105°C
适用线规 Wire range: AWG#28~#14

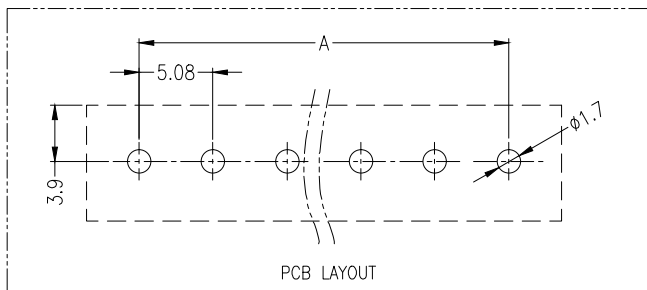

SECTION A-A

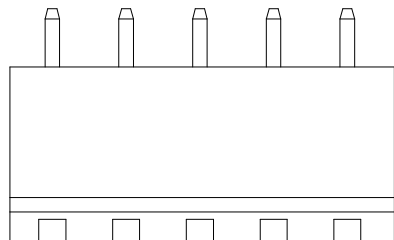
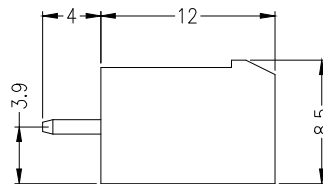
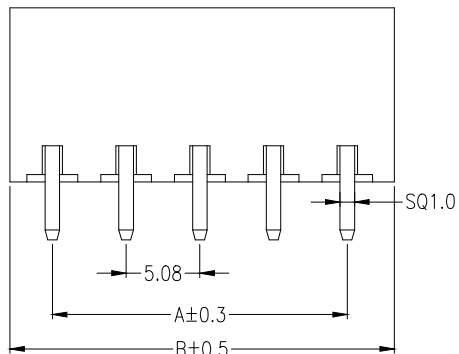

PCB LAYOUT

材料及电镀

- ①. 塑件主体: PA66, UL94V-0
- ②. 焊 针: 黄铜, 镀镍

电气性能

- 额定电压: 300V
- 额定电流: 15A
- 接触电阻: 20mΩ (Max)
- 绝缘电阻: 500MΩ DC500V
- 耐 电 压: AC2000V\1Min

机械性能

- 温度范围: -40℃ ~ +105℃
- 瞬时温度: +250℃ ,5秒

Circuits	Product name	Dimensino (mm)	
		A	B
2	2EDG-5.08-2A	5.08	10.96
3	2EDG-5.08-3A	10.16	16.04
4	2EDG-5.08-4A	15.24	21.12
5	2EDG-5.08-5A	20.32	26.20
6	2EDG-5.08-6A	25.40	31.28
7	2EDG-5.08-7A	30.48	36.36
8	2EDG-5.08-8A	35.56	41.44
9	2EDG-5.08-9A	40.64	46.52
10	2EDG-5.08-10A	45.72	51.60
11	2EDG-5.08-11A	50.80	56.68
12	2EDG-5.08-12A	55.88	61.76
13	2EDG-5.08-13A	60.96	66.84
14	2EDG-5.08-14A	66.04	71.92
15	2EDG-5.08-15A	71.12	77.00
~	~	~	~
24	2EDG-5.08-24A	116.84	122.72

			GENE RL TOLERANCE	制 图 DRAWING	ZHE JIANG DELI CONNECTORS CO ., LTD				
			DIM	TOL	审 核 CHECK				
			X. X	±0.50	批 准 APPROVAL	产品名称 TITLE	2EDG-5.08-A	版本 REV.	A
1	初版发行		X. XX	±0.30	比 例 SCALE	产品料号 PART NO.		单 位 UNITS	mm
序号 No.	变更内容 MODIFY CONTENT	日期 MODIFY DATE	X. XXX	±0.10	投 影 Projection	材 料 MATERIAL		页 次 SHEET	1/1
			Angle	±3.0°					

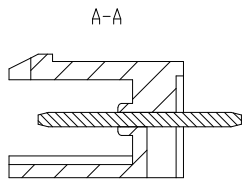
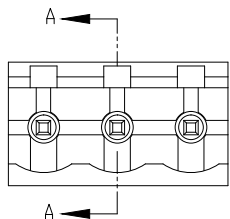

SECTION A-A

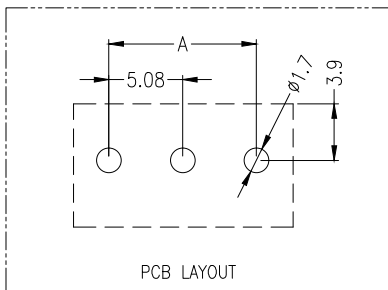
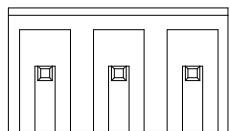
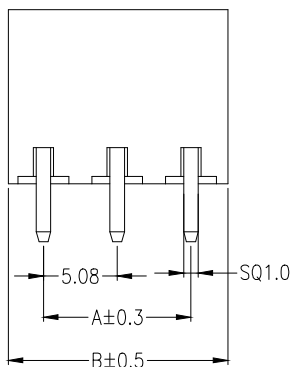

材料及电镀

- ①. 塑件主体: PA66, UL94V-0
- ②. 焊 针: 黄铜, 镀镍

电气性能

- 额定电压: 300V
- 额定电流: 15A
- 接触电阻: 20mΩ (Max)
- 绝缘电阻: 500MΩ \DC500V
- 耐 电 压: AC2000V\1Min

机械性能

- 温度范围: -40℃ ~ +105℃
- 瞬时温度: +250℃ ,5秒

Circuits	Product name	Dimensino(mm)	
		A	B
2	2EDG-5.08-2AH	5.08	10.16
3	2EDG-5.08-3AH	10.16	15.24
4	2EDG-5.08-4AH	15.24	20.32
5	2EDG-5.08-5AH	20.32	25.40
6	2EDG-5.08-6AH	25.40	30.48
7	2EDG-5.08-7AH	30.48	35.56
8	2EDG-5.08-8AH	35.56	40.64
9	2EDG-5.08-9AH	40.64	45.72
10	2EDG-5.08-10AH	45.72	50.80
11	2EDG-5.08-11AH	50.80	55.88
12	2EDG-5.08-12AH	55.88	60.96
13	2EDG-5.08-13AH	60.96	66.04
14	2EDG-5.08-14AH	66.04	71.12
15	2EDG-5.08-15AH	71.12	76.20
~	~	~	~
24	2EDG-5.08-24AH	116.84	121.92

			GENEERL TOLERANCE	制 图 DRAWING	ZHE JIANG DELI CONNECTORS CO.,LTD			
			DIM TOL	审 核 CHECK				
			X.X ±0.50	批 准 APPROVAL	产品名称 TITLE	2EDG-5.08-AH	版本 REV.	A
1	初版发行		X.XX ±0.30	比 例 SCALE	产品料号 PART NO.		单 位 UNITS	mm
序号 No.	变更内容 MODIFY CONTENT	日期 MODIFY DATE	X.XXX ±0.10	投 影 Projection	材 料 MATERIAL		页 次 SHEET	1/1
			Angle ±3.0°					



SECTION A-A

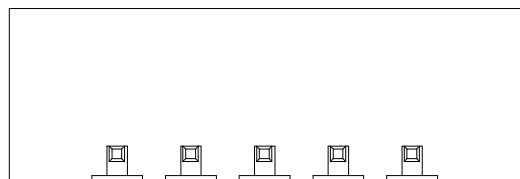

材料及电镀

- ①. 塑件主体: PA66, UL94V-0
- ②. 焊 针: 黄铜, 镀镍

电气性能

额定电压: 300V
 额定电流: 15A
 接触电阻: 20mΩ (Max)
 绝缘电阻: 500MΩ \DC500V
 耐 电 压: AC2000V\1Min

机械性能

温度范围: -40℃ ~ +105℃
 瞬时温度: +250℃ ,5秒

Circuits	Product name	Dimensino (mm)	
		A	B
2	2EDG-5.08-2AWLS	5.08	11.16
3	2EDG-5.08-3AWLS	10.16	16.24
4	2EDG-5.08-4AWLS	15.24	21.32
5	2EDG-5.08-5AWLS	20.32	26.40
6	2EDG-5.08-6AWLS	25.40	31.48
7	2EDG-5.08-7AWLS	30.48	36.56
8	2EDG-5.08-8AWLS	35.56	41.64
9	2EDG-5.08-9AWLS	40.64	46.72
10	2EDG-5.08-10AWLS	45.72	51.80
11	2EDG-5.08-11AWLS	50.80	56.88
12	2EDG-5.08-12AWLS	55.88	61.96
13	2EDG-5.08-13AWLS	60.96	67.04
14	2EDG-5.08-14AWLS	66.04	72.12
15	2EDG-5.08-15AWLS	71.12	77.20
~	~	~	~
24	2EDG-5.08-24AWLS	116.84	122.92

			GENE RL TOLERANCE	制 图 DRAWING	ZHE JIANG DELI CONNECTORS CO ., LTD			
			DIM TOL	审 核 CHECK				
			X.X ±0.50	批 准 APPROVAL	产 品 名 称 TITLE	2EDG-5.08-AWLS	版 本 REV.	A
1	初版发行		X.XX ±0.30	比 例 SCALE	产 品 料 号 PART NO.		单 位 UNITS	mm
序号 No.	变 更 内 容 MODIFY CONTENT	日 期 MODIFY DATE	X.XXX ±0.10	投 影 Projection	材 料 MATERIAL		页 次 SHEET	1/1
			Angle ±3.0°					

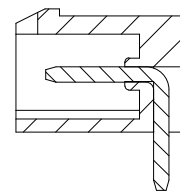
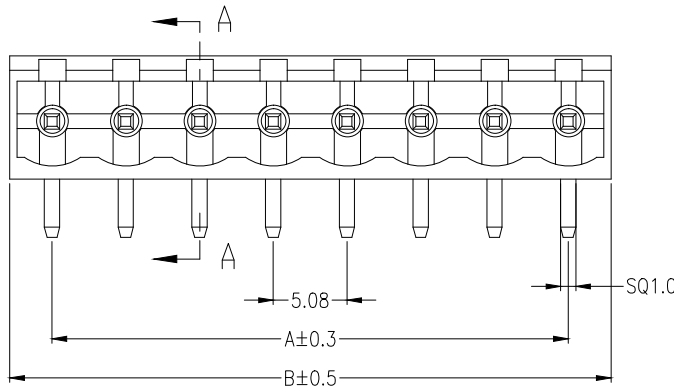
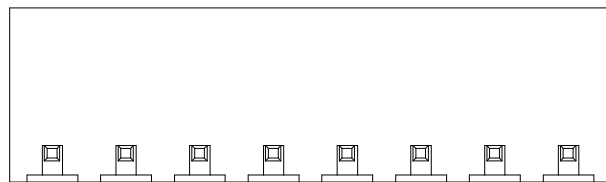
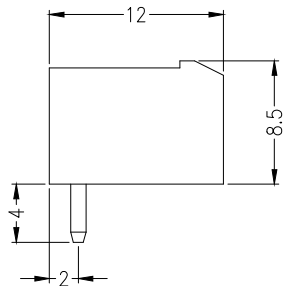

SECTION A-A

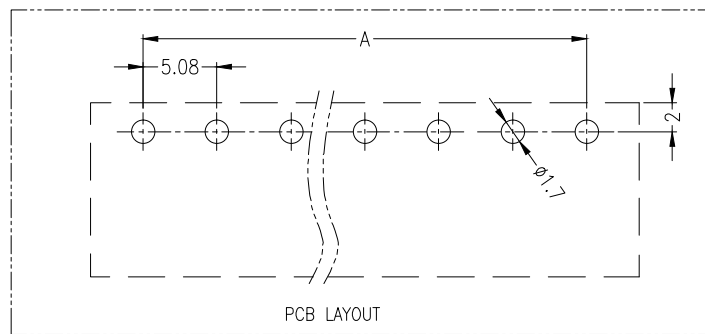
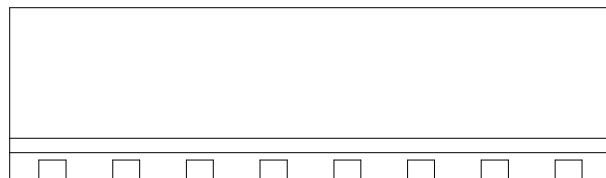

材料及电镀
 ①. 塑件主体: PA66, UL94V-0
 ②. 焊 针: 黄铜, 镀镍

电气性能
 额定电压: 300V
 额定电流: 15A
 接触电阻: 20mΩ (Max)
 绝缘电阻: 500MΩ \DC500V
 耐 电 压: AC2000V\1Min

机械性能
 温度范围: -40℃ ~ +105℃
 瞬时温度: +250℃, 5秒

Circuits	Product name	Dimensino (mm)	
		A	B
2	2EDG-5.08-2AW	5.08	10.96
3	2EDG-5.08-3AW	10.16	16.04
4	2EDG-5.08-4AW	15.24	21.12
5	2EDG-5.08-5AW	20.32	26.20
6	2EDG-5.08-6AW	25.40	31.28
7	2EDG-5.08-7AW	30.48	36.36
8	2EDG-5.08-8AW	35.56	41.44
9	2EDG-5.08-9AW	40.64	46.52
10	2EDG-5.08-10AW	45.72	51.60
11	2EDG-5.08-11AW	50.80	56.68
12	2EDG-5.08-12AW	55.88	61.76
13	2EDG-5.08-13AW	60.96	66.84
14	2EDG-5.08-14AW	66.04	71.92
15	2EDG-5.08-15AW	71.12	77.00
~	~	~	~
24	2EDG-5.08-24AW	116.84	122.72

			GENE RL TOLERANCE	制 图 DRAWING	ZHE JIANG DELI CONNECTORS CO., LTD			
			DIM TOL	审 核 CHECK				
			X.X ±0.50	批 准 APPROVAL	产品名称 TITLE	2EDG-5.08-AW	版 本 REV.	A
			X.XX ±0.30	比 例 SCALE	产品料号 PART NO.		单 位 UNITS	mm
1	初版发行		X.XXX ±0.10	投 影 Projection	材 料 MATERIAL		页 次 SHEET	1/1
序号 No.	变更内容 MODIFY CONTENT	日期 MODIFY DATE	Angle ±3.0°					

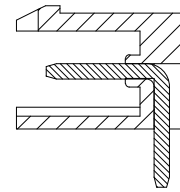
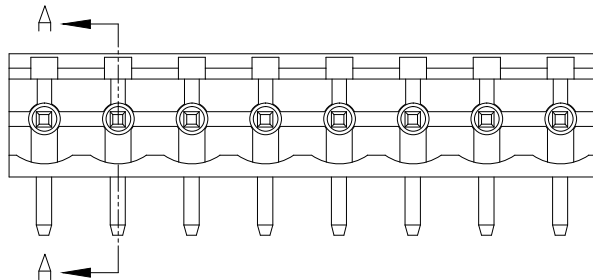

SECTION A-A

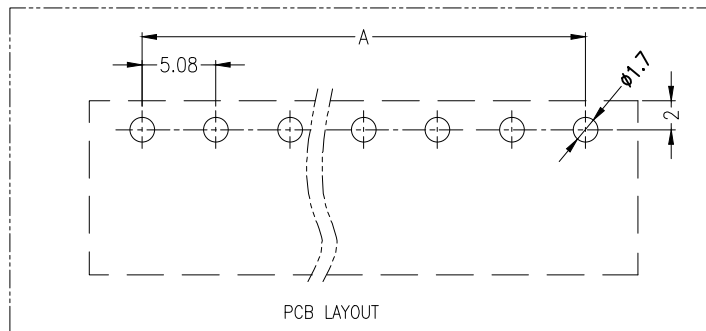
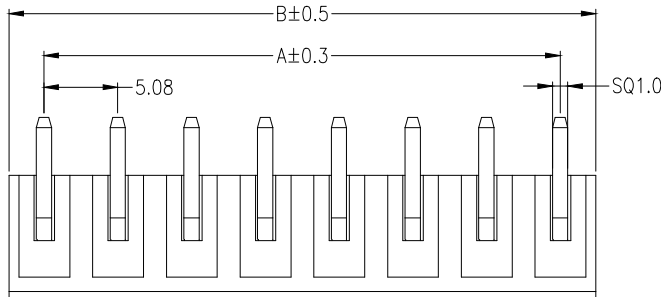
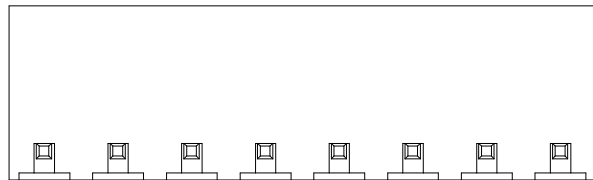

电气性能
 额定电压: 300V
 额定电流: 15A
 接触电阻: 20mΩ (Max)
 绝缘电阻: 500MΩ \DC500V
 耐电压: AC2000V\1Min

机械性能
 温度范围: -40°C ~ +105°C
 瞬时温度: +250°C ,5秒

材料及电镀
 ①. 塑件主体: PA66, UL94V-0
 ②. 焊 针: 黄铜, 镀镍

Circuits	Product name	Dimensino (mm)	
		A	B
2	2EDG-5.08-2AWH	5.08	10.16
3	2EDG-5.08-3AWH	10.16	15.24
4	2EDG-5.08-4AWH	15.24	20.32
5	2EDG-5.08-5AWH	20.32	25.40
6	2EDG-5.08-6AWH	25.40	30.48
7	2EDG-5.08-7AWH	30.48	35.56
8	2EDG-5.08-8AWH	35.56	40.64
9	2EDG-5.08-9AWH	40.64	45.72
10	2EDG-5.08-10AWH	45.72	50.80
11	2EDG-5.08-11AWH	50.80	55.88
12	2EDG-5.08-12AWH	55.88	60.96
13	2EDG-5.08-13AWH	60.96	66.04
14	2EDG-5.08-14AWH	66.04	71.12
15	2EDG-5.08-15AWH	71.12	76.20
~	~	~	~
24	2EDG-5.08-24AWH	116.84	121.92

			GENERAL TOLERANCE	制图 DRAWING	ZHE JIANG DELI CONNECTORS CO.,LTD			
			DIM TOL	审核 CHECK				
			X.X ±0.50	批准 APPROVAL	产品名称 TITLE	2EDG-5.08-AWH	版本 REV.	A
1	初版发行		X.XX ±0.30	比例 SCALE	产品料号 PART NO.		单位 UNITS	mm
序号 No.	变更内容 MODIFY CONTENT	日期 MODIFY DATE	X.XXX ±0.10	投影 Projection	材料 MATERIAL		页次 SHEET	1/1
			Angle ±3.0°					



材料及电镀
 ① 塑件主体: PA66, UL94V-0
 ② 焊 针: 黄铜, 镀镍

电气性能
 额定电压: 300V
 额定电流: 15A
 接触电阻: 20mΩ (Max)
 绝缘电阻: 500MΩ \DC500V
 耐 电 压: AC2000V\1min

机械性能
 温度范围: -40℃ ~ +105℃
 瞬时温度: +250℃ ,5秒

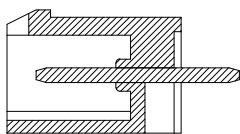

SECTION A-A

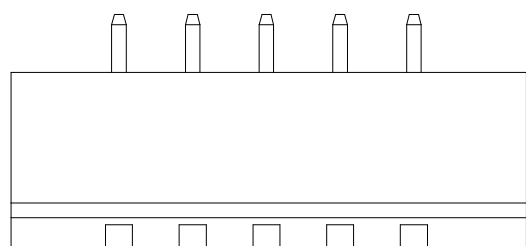
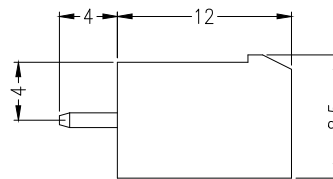

Circuits	Product name	Dimensino (mm)	
		A	B
2	2EDG-5.08-2ALS	5.08	10.96
3	2EDG-5.08-3ALS	10.16	16.04
4	2EDG-5.08-4ALS	15.24	21.12
5	2EDG-5.08-5ALS	20.32	26.20
6	2EDG-5.08-6ALS	25.40	31.28
7	2EDG-5.08-7ALS	30.48	36.36
8	2EDG-5.08-8ALS	35.56	41.44
9	2EDG-5.08-9ALS	40.64	46.52
10	2EDG-5.08-10ALS	45.72	51.60
11	2EDG-5.08-11ALS	50.80	56.68
12	2EDG-5.08-12ALS	55.88	61.76
13	2EDG-5.08-13ALS	60.96	66.84
14	2EDG-5.08-14ALS	66.04	71.92
15	2EDG-5.08-15ALS	71.12	77.00
~	~	~	~
24	2EDG-5.08-24ALS	116.84	122.72

			GENEERL TOLERANCE	制 图 DRAWING	ZHE JIANG DELI CONNECTORS CO ., LTD			
			DIM TOL	审 核 CHECK			版 本 REV.	A
			X.X ±0.50	批 准 APPROVAL	产品名称 TITLE	2EDG-5.08-ALS	单 位 UNITS	mm
1	初版发行		X.XX ±0.30	比 例 SCALE	产品料号 PART NO.		页 次 SHEET	1/1
序号 No.	变更内容 MODIFY CONTENT	日期 MODIFY DATE	X.XXX ±0.10	投 影 Projection	材 料 MATERIAL			
			Angle ±3.0°					



材料及电镀

- ①. 螺 丝: M2.5, 钢, 镀锌, 一字槽
- ②. 塑件主体: PA66, UL94V-0
- ③. 夹 子: 磷青铜, 镀镍
- ④. 方 盒: 黄铜, 镀镍
- ⑤. 塑件盖板: PA66, UL94V-0

电气性能

- 额定电压: 300V
- 额定电流: 15A
- 接触电阻: 20mΩ (Max)
- 绝缘电阻: 500MΩ \DC500V
- 耐 电 压: AC2000V\1min
- 使用线径: 28-14AWG 2.5mm²

机械性能

- 温度范围: -40℃ ~ +105℃
- 瞬时温度: +250℃ 5秒
- 扭 力: 0.5Nm (4.43Lbin)
- 剥线长度: 7-8mm

3 Pin以上

2 Pin

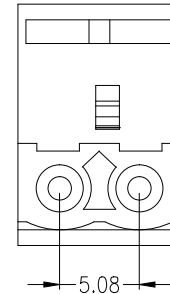
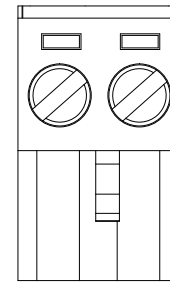
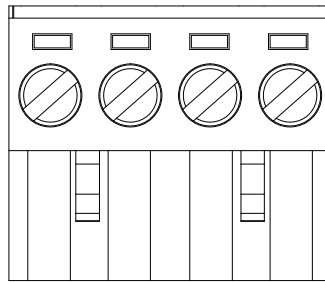

Circuits	Product name	Dimensino (mm)	
		A	B
2	2EDG-5.08-2Y	5.08	10.96
3	2EDG-5.08-3Y	10.16	16.04
4	2EDG-5.08-4Y	15.24	21.12
5	2EDG-5.08-5Y	20.32	26.20
6	2EDG-5.08-6Y	25.40	31.28
7	2EDG-5.08-7Y	30.48	36.36
8	2EDG-5.08-8Y	35.56	41.44
9	2EDG-5.08-9Y	40.64	46.52
10	2EDG-5.08-10Y	45.72	51.60
11	2EDG-5.08-11Y	50.80	56.68
12	2EDG-5.08-12Y	55.88	61.76
13	2EDG-5.08-13Y	60.96	66.84
14	2EDG-5.08-14Y	66.04	71.92
15	2EDG-5.08-15Y	71.12	77.00
~	~	~	~
24	2EDG-5.08-24Y	116.84	122.72

			GENEERL TOLERANCE		制 图 DRAWING		ZHE JIANG DELI CONNECTORS CO., LTD				
			DIM	TOL	审 核 CHECK						
			X.X	±0.50	批 准 APPROVAL		产品名称 TITLE	2EDG-5.08-Y		版本 REV.	A
			X.XX	±0.30	比 例 SCALE		产品料号 PART NO.			单 位 UNITS	mm
			X.XXX	±0.10	投 影 Projection		材 料 MATERIAL			页 次 SHEET	1/1
			Angle	±3.0°							
1	初版发行										
序号 No.	变更内容 MODIFY CONTENT	日期 MODIFY DATE									



材料及电镀

- ①. 螺 丝: M2.5, 钢, 镀锌, 一字槽
- ②. 塑件主体: PA66, UL94V-0
- ③. 夹 子: 磷青铜, 镀镍
- ④. 方 盒: 黄铜, 镀镍
- ⑤. 塑件盖板: PA66, UL94V-0

电气性能
 额定电压: 300V
 额定电流: 15A
 接触电阻: 20mΩ (Max)
 绝缘电阻: 500MΩ \DC500V
 耐 电 压: AC2000V\1Min
 使用线径: 28-14AWG 2.5mm²

3 Pin以上

2 Pin

机械性能
 温度范围: -40℃ ~ +105℃
 瞬时温度: +250℃ 5秒
 扭 力: 0.5Nm(4.43Lbin)
 剥线长度: 7-8mm

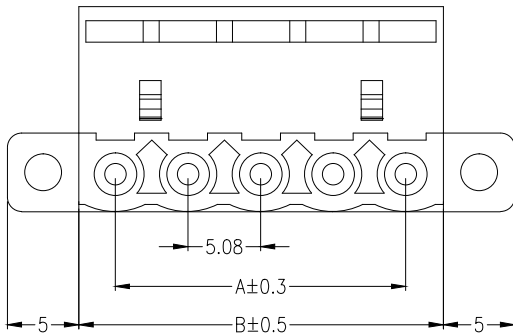
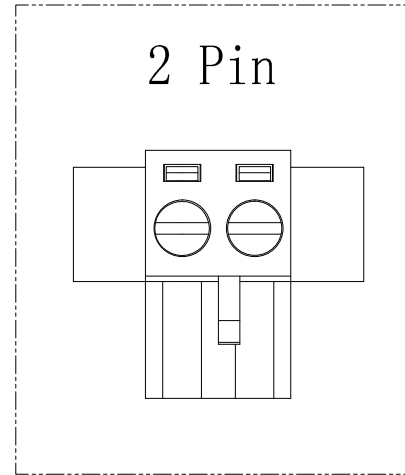
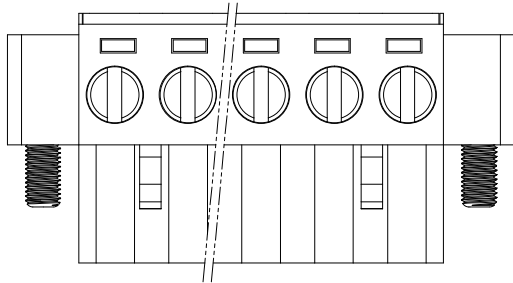
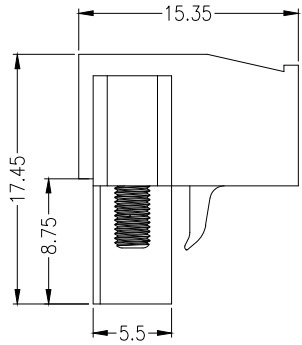

Circuits	Product name	Dimensino (mm)	
		A	B
2	2EDG-5.08-2YLS	5.08	11.16
3	2EDG-5.08-3YLS	10.16	16.24
4	2EDG-5.08-4YLS	15.24	21.32
5	2EDG-5.08-5YLS	20.32	26.40
6	2EDG-5.08-6YLS	25.40	31.48
7	2EDG-5.08-7YLS	30.48	36.56
8	2EDG-5.08-8YLS	35.56	41.64
9	2EDG-5.08-9YLS	40.64	46.72
10	2EDG-5.08-10YLS	45.72	51.80
11	2EDG-5.08-11YLS	50.80	56.88
12	2EDG-5.08-12YLS	55.88	61.96
13	2EDG-5.08-13YLS	60.96	67.04
14	2EDG-5.08-14YLS	66.04	72.12
15	2EDG-5.08-15YLS	71.12	77.20
~	~	~	~
24	2EDG-5.08-24YLS	116.84	122.92

			GENEAL TOLERANCE		制 图 DRAWING		ZHE JIANG DELI CONNECTORS CO., LTD			
			DIM	TOL	审 核 CHECK					
			X.X	±0.50	批 准 APPROVAL		产品名称 TITLE	2EDG-5.08-YLS	版本 REV.	A
1			初版发行		比 例 SCALE		产品料号 PART NO.		单 位 UNITS	mm
序号 No.	变更内容 MODIFY CONTENT	日期 MODIFY DATE	Angle ±3.0°		投 影 Projection		材 料 MATERIAL		页 次 SHEET	1/1

X-ON Electronics

Largest Supplier of Electrical and Electronic Components

Click to view similar products for [Pluggable Terminal Blocks](#) category:

Click to view products by [DLL](#) manufacturer:

Other Similar products are found below :

[57.510.0053](#) [721-104/026-047](#) [721-204/026-045](#) [MC 1.5/ 6-ST-3.5 GY AU](#) [ET02015000J0G](#) [860505](#) [860516](#) [860810](#) [GBPACX-12](#)
[93.731.4953.0](#) [PVP03-3,50](#) [PVS02-5,00](#) [1-1986160-3](#) [1377680000](#) [1531000000](#) [1546228-5](#) [ELFP03110](#) [ELFP10210](#) [ELFT07250](#)
[ELVD12100](#) [ELVF09400](#) [ELXH071G0E](#) [1725220000](#) [1760336](#) [1855000000](#) [19346](#) [1946309](#) [1973592](#) [19892](#) [25.320.4053.1](#) [25.320.4553.9](#)
[25.320.4753.1](#) [25.320.5453.1](#) [25.340.0353.1](#) [25.340.1053.1](#) [25.345.3553.0M001](#) [25.640.3553.1](#) [SH02-5,08](#) [SH06-3,81](#) [SH08-5,08](#) [SH08-](#)
[5,08-K](#) [SH12-5,08](#) [SHS04-5,00](#) [30.303](#) [30.305](#) [30.306](#) [PHP09-5,08](#) [25.193.0453.0](#) [25.320.4653.1](#) [25.332.2453.1](#)