

**技术特性/Specifications:**

额定电压 Rated voltage: 300V AC, DC  
额定电流 Rated current: 18A AC, DC  
接触电阻 Contact resistance: 20m $\Omega$  max  
绝缘电阻 Insulation resistance: 500M $\Omega$  min  
耐压 Withstand voltage: 2000V AC/minute  
环境温度 Ambient temperature: -40 $^{\circ}$ C~+105 $^{\circ}$ C  
适用线规 Wire range: AWG#28~#14

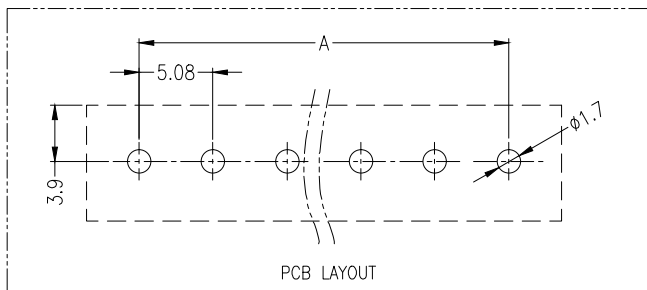

SECTION A-A

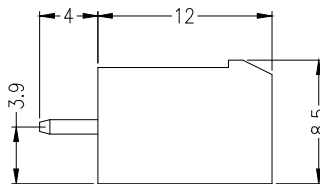
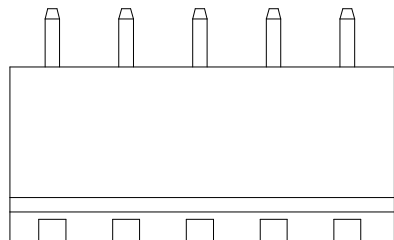
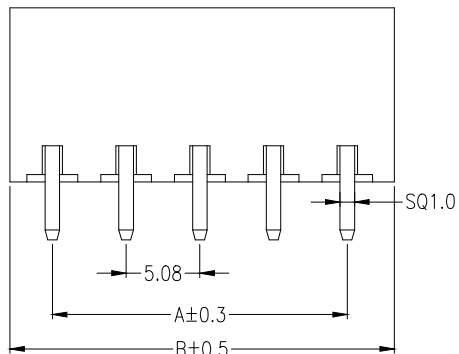

PCB LAYOUT

材料及电镀

- ①. 塑件主体: PA66, UL94V-0
- ②. 焊 针: 黄铜, 镀镍

电气性能

- 额定电压: 300V
- 额定电流: 15A
- 接触电阻: 20mΩ (Max)
- 绝缘电阻: 500MΩ DC500V
- 耐 电 压: AC2000V\1Min

机械性能

- 温度范围: -40℃ ~ +105℃
- 瞬时温度: +250℃ ,5秒

| Circuits | Product name  | Dimensino (mm) |        |
|----------|---------------|----------------|--------|
|          |               | A              | B      |
| 2        | 2EDG-5.08-2A  | 5.08           | 10.96  |
| 3        | 2EDG-5.08-3A  | 10.16          | 16.04  |
| 4        | 2EDG-5.08-4A  | 15.24          | 21.12  |
| 5        | 2EDG-5.08-5A  | 20.32          | 26.20  |
| 6        | 2EDG-5.08-6A  | 25.40          | 31.28  |
| 7        | 2EDG-5.08-7A  | 30.48          | 36.36  |
| 8        | 2EDG-5.08-8A  | 35.56          | 41.44  |
| 9        | 2EDG-5.08-9A  | 40.64          | 46.52  |
| 10       | 2EDG-5.08-10A | 45.72          | 51.60  |
| 11       | 2EDG-5.08-11A | 50.80          | 56.68  |
| 12       | 2EDG-5.08-12A | 55.88          | 61.76  |
| 13       | 2EDG-5.08-13A | 60.96          | 66.84  |
| 14       | 2EDG-5.08-14A | 66.04          | 71.92  |
| 15       | 2EDG-5.08-15A | 71.12          | 77.00  |
| ~        | ~             | ~              | ~      |
| 24       | 2EDG-5.08-24A | 116.84         | 122.72 |

|           |                        |                   | GENE RL TOLERANCE | 制 图<br>DRAWING | ZHE JIANG DELI CONNECTORS CO ., LTD |                  |             |              |     |
|-----------|------------------------|-------------------|-------------------|----------------|-------------------------------------|------------------|-------------|--------------|-----|
|           |                        |                   | DIM               | TOL            | 审 核<br>CHECK                        |                  |             |              |     |
|           |                        |                   | X. X              | ±0.50          | 批 准<br>APPROVAL                     | 产品名称<br>TITLE    | 2EDG-5.08-A | 版本<br>REV.   | A   |
| 1         | 初版发行                   |                   | X. XX             | ±0.30          | 比 例<br>SCALE                        | 产品料号<br>PART NO. |             | 单 位<br>UNITS | mm  |
| 序号<br>No. | 变更内容<br>MODIFY CONTENT | 日期<br>MODIFY DATE | X. XXX            | ±0.10          | 投 影<br>Projection                   | 材 料<br>MATERIAL  |             | 页 次<br>SHEET | 1/1 |
|           |                        |                   | Angle             | ±3.0°          |                                     |                  |             |              |     |

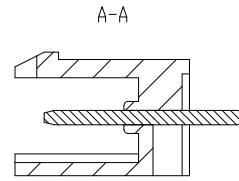
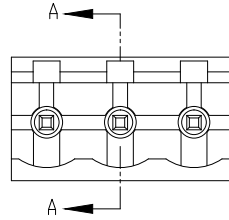
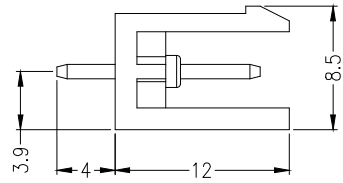

SECTION A-A

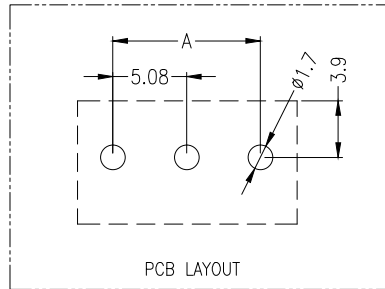
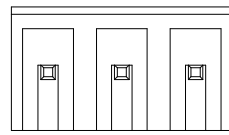
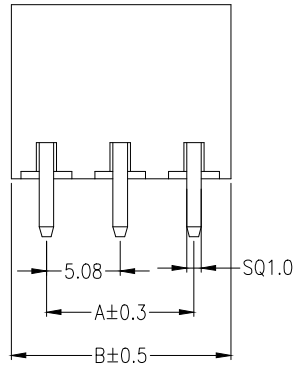

材料及电镀

- ①. 塑件主体: PA66, UL94V-0
- ②. 焊 针: 黄铜, 镀镍

电气性能

- 额定电压: 300V
- 额定电流: 15A
- 接触电阻: 20mΩ (Max)
- 绝缘电阻: 500MΩ \DC500V
- 耐 电 压: AC2000V\1Min

机械性能

- 温度范围: -40℃ ~ +105℃
- 瞬时温度: +250℃ ,5秒

| Circuits | Product name   | Dimensino(mm) |        |
|----------|----------------|---------------|--------|
|          |                | A             | B      |
| 2        | 2EDG-5.08-2AH  | 5.08          | 10.16  |
| 3        | 2EDG-5.08-3AH  | 10.16         | 15.24  |
| 4        | 2EDG-5.08-4AH  | 15.24         | 20.32  |
| 5        | 2EDG-5.08-5AH  | 20.32         | 25.40  |
| 6        | 2EDG-5.08-6AH  | 25.40         | 30.48  |
| 7        | 2EDG-5.08-7AH  | 30.48         | 35.56  |
| 8        | 2EDG-5.08-8AH  | 35.56         | 40.64  |
| 9        | 2EDG-5.08-9AH  | 40.64         | 45.72  |
| 10       | 2EDG-5.08-10AH | 45.72         | 50.80  |
| 11       | 2EDG-5.08-11AH | 50.80         | 55.88  |
| 12       | 2EDG-5.08-12AH | 55.88         | 60.96  |
| 13       | 2EDG-5.08-13AH | 60.96         | 66.04  |
| 14       | 2EDG-5.08-14AH | 66.04         | 71.12  |
| 15       | 2EDG-5.08-15AH | 71.12         | 76.20  |
| ~        | ~              | ~             | ~      |
| 24       | 2EDG-5.08-24AH | 116.84        | 121.92 |

|           |                        |                   |                   |                   |                                   |              |              |     |
|-----------|------------------------|-------------------|-------------------|-------------------|-----------------------------------|--------------|--------------|-----|
|           |                        |                   | GENEERL TOLERANCE | 制 图<br>DRAWING    | ZHE JIANG DELI CONNECTORS CO.,LTD |              |              |     |
|           |                        |                   | DIM TOL           | 审 核<br>CHECK      |                                   |              |              |     |
|           |                        |                   | X.X ±0.50         | 批 准<br>APPROVAL   | 产品名称<br>TITLE                     | 2EDG-5.08-AH | 版本<br>REV.   | A   |
|           |                        |                   | X.XX ±0.30        | 比 例<br>SCALE      | 产品料号<br>PART NO.                  |              | 单 位<br>UNITS | mm  |
| 1         | 初版发行                   |                   | X.XXX ±0.10       | 投 影<br>Projection | 材 料<br>MATERIAL                   |              | 页 次<br>SHEET | 1/1 |
| 序号<br>No. | 变更内容<br>MODIFY CONTENT | 日期<br>MODIFY DATE | Angle ±3.0°       |                   |                                   |              |              |     |



SECTION A-A

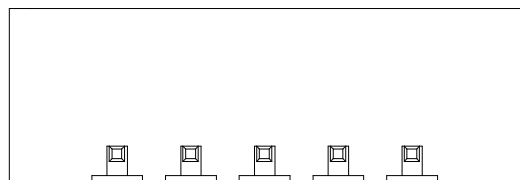

材料及电镀

- ①. 塑件主体: PA66, UL94V-0
- ②. 焊 针: 黄铜, 镀镍

电气性能

- 额定电压: 300V
- 额定电流: 15A
- 接触电阻: 20mΩ (Max)
- 绝缘电阻: 500MΩ \DC500V
- 耐 电 压: AC2000V\1Min

机械性能

- 温度范围: -40℃ ~ +105℃
- 瞬时温度: +250℃ ,5秒

| Circuits | Product name     | Dimensino (mm) |        |
|----------|------------------|----------------|--------|
|          |                  | A              | B      |
| 2        | 2EDG-5.08-2AWLS  | 5.08           | 11.16  |
| 3        | 2EDG-5.08-3AWLS  | 10.16          | 16.24  |
| 4        | 2EDG-5.08-4AWLS  | 15.24          | 21.32  |
| 5        | 2EDG-5.08-5AWLS  | 20.32          | 26.40  |
| 6        | 2EDG-5.08-6AWLS  | 25.40          | 31.48  |
| 7        | 2EDG-5.08-7AWLS  | 30.48          | 36.56  |
| 8        | 2EDG-5.08-8AWLS  | 35.56          | 41.64  |
| 9        | 2EDG-5.08-9AWLS  | 40.64          | 46.72  |
| 10       | 2EDG-5.08-10AWLS | 45.72          | 51.80  |
| 11       | 2EDG-5.08-11AWLS | 50.80          | 56.88  |
| 12       | 2EDG-5.08-12AWLS | 55.88          | 61.96  |
| 13       | 2EDG-5.08-13AWLS | 60.96          | 67.04  |
| 14       | 2EDG-5.08-14AWLS | 66.04          | 72.12  |
| 15       | 2EDG-5.08-15AWLS | 71.12          | 77.20  |
| ~        | ~                | ~              | ~      |
| 24       | 2EDG-5.08-24AWLS | 116.84         | 122.92 |

|           |                        |                   |                   |       |                  |  |                                   |                |             |     |
|-----------|------------------------|-------------------|-------------------|-------|------------------|--|-----------------------------------|----------------|-------------|-----|
|           |                        |                   | GENERAL TOLERANCE |       | 制图<br>DRAWING    |  | ZHE JIANG DELI CONNECTORS CO.,LTD |                |             |     |
|           |                        |                   | DIM               | TOL   | 审核<br>CHECK      |  |                                   |                |             |     |
|           |                        |                   | X.X               | ±0.50 | 批准<br>APPROVAL   |  | 产品名称<br>TITLE                     | 2EDG-5.08-AWLS | 版本<br>REV.  | A   |
| 1         |                        |                   | 初版发行              |       | 比例<br>SCALE      |  | 产品料号<br>PART NO.                  |                | 单位<br>UNITS | mm  |
| 序号<br>No. | 变更内容<br>MODIFY CONTENT | 日期<br>MODIFY DATE | Angle ±3.0°       |       | 投影<br>Projection |  | 材料<br>MATERIAL                    |                | 页次<br>SHEET | 1/1 |

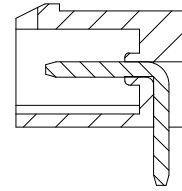
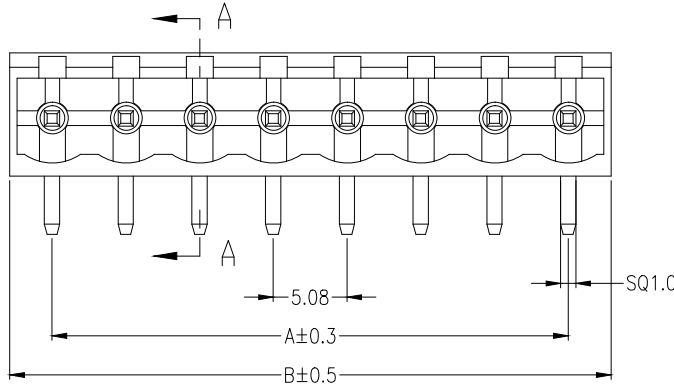
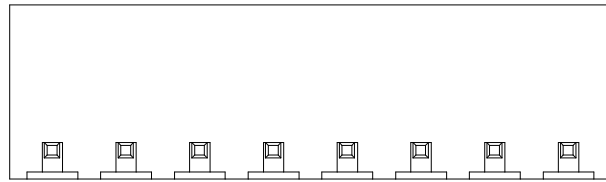
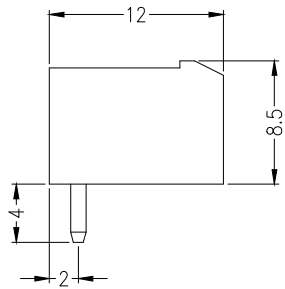

SECTION A-A

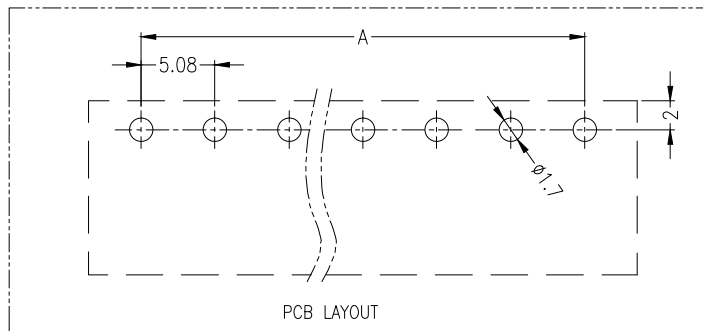
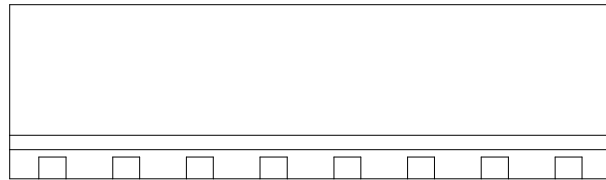

材料及电镀

- ①. 塑件主体: PA66, UL94V-0
- ②. 焊 针: 黄铜, 镀镍

电气性能

- 额定电压: 300V
- 额定电流: 15A
- 接触电阻: 20mΩ (Max)
- 绝缘电阻: 500MΩ \DC500V
- 耐 电 压: AC2000V\1Min

机械性能

- 温度范围: -40℃ ~ +105℃
- 瞬时温度: +250℃ ,5秒

| Circuits | Product name   | Dimensino (mm) |        |
|----------|----------------|----------------|--------|
|          |                | A              | B      |
| 2        | 2EDG-5.08-2AW  | 5.08           | 10.96  |
| 3        | 2EDG-5.08-3AW  | 10.16          | 16.04  |
| 4        | 2EDG-5.08-4AW  | 15.24          | 21.12  |
| 5        | 2EDG-5.08-5AW  | 20.32          | 26.20  |
| 6        | 2EDG-5.08-6AW  | 25.40          | 31.28  |
| 7        | 2EDG-5.08-7AW  | 30.48          | 36.36  |
| 8        | 2EDG-5.08-8AW  | 35.56          | 41.44  |
| 9        | 2EDG-5.08-9AW  | 40.64          | 46.52  |
| 10       | 2EDG-5.08-10AW | 45.72          | 51.60  |
| 11       | 2EDG-5.08-11AW | 50.80          | 56.68  |
| 12       | 2EDG-5.08-12AW | 55.88          | 61.76  |
| 13       | 2EDG-5.08-13AW | 60.96          | 66.84  |
| 14       | 2EDG-5.08-14AW | 66.04          | 71.92  |
| 15       | 2EDG-5.08-15AW | 71.12          | 77.00  |
| ~        | ~              | ~              | ~      |
| 24       | 2EDG-5.08-24AW | 116.84         | 122.72 |

|           |                        |                   |                   |                   |                                    |              |              |     |
|-----------|------------------------|-------------------|-------------------|-------------------|------------------------------------|--------------|--------------|-----|
|           |                        |                   | GENEERL TOLERANCE | 制 图<br>DRAWING    | ZHE JIANG DELI CONNECTORS CO., LTD |              |              |     |
|           |                        |                   | DIM TOL           | 审 核<br>CHECK      |                                    |              |              |     |
|           |                        |                   | X.X ±0.50         | 批 准<br>APPROVAL   | 产品名称<br>TITLE                      | 2EDG-5.08-AW | 版 本<br>REV.  | A   |
|           |                        |                   | X.XX ±0.30        | 比 例<br>SCALE      | 产品料号<br>PART NO.                   |              | 单 位<br>UNITS | mm  |
| 1         | 初版发行                   |                   | X.XXX ±0.10       | 投 影<br>Projection | 材 料<br>MATERIAL                    |              | 页 次<br>SHEET | 1/1 |
| 序号<br>No. | 变更内容<br>MODIFY CONTENT | 日期<br>MODIFY DATE | Angle ±3.0°       |                   |                                    |              |              |     |

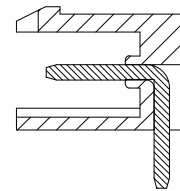
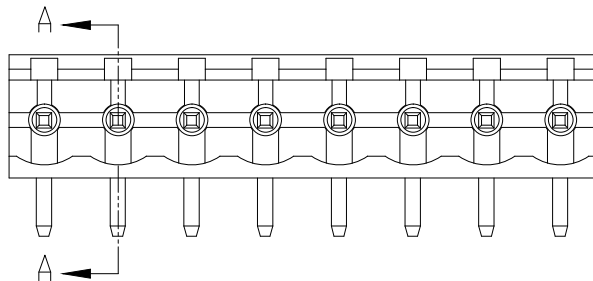

SECTION A-A

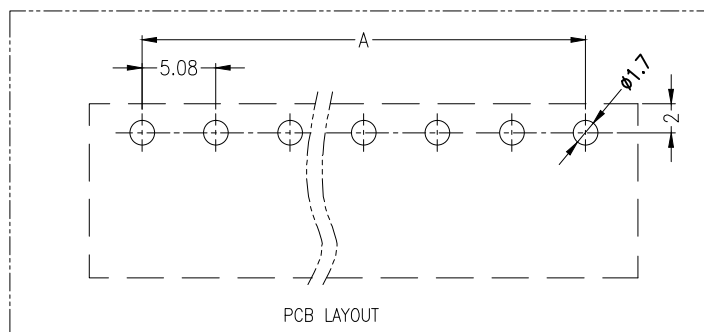
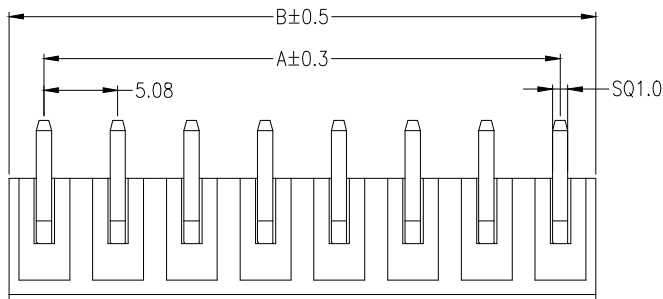
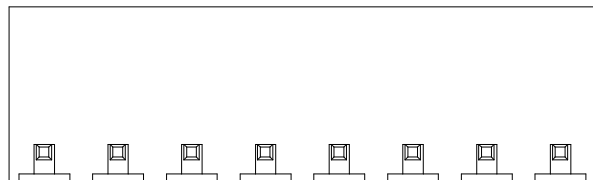

电气性能  
 额定电压: 300V  
 额定电流: 15A  
 接触电阻: 20mΩ (Max)  
 绝缘电阻: 500MΩ \DC500V  
 耐电压: AC2000V\1Min

机械性能  
 温度范围: -40°C ~ +105°C  
 瞬时温度: +250°C ,5秒

材料及电镀  
 ①. 塑件主体: PA66, UL94V-0  
 ②. 焊 针: 黄铜, 镀镍

| Circ<br>uits | Product name    | Dimensino (mm) |        |
|--------------|-----------------|----------------|--------|
|              |                 | A              | B      |
| 2            | 2EDG-5.08-2AWH  | 5.08           | 10.16  |
| 3            | 2EDG-5.08-3AWH  | 10.16          | 15.24  |
| 4            | 2EDG-5.08-4AWH  | 15.24          | 20.32  |
| 5            | 2EDG-5.08-5AWH  | 20.32          | 25.40  |
| 6            | 2EDG-5.08-6AWH  | 25.40          | 30.48  |
| 7            | 2EDG-5.08-7AWH  | 30.48          | 35.56  |
| 8            | 2EDG-5.08-8AWH  | 35.56          | 40.64  |
| 9            | 2EDG-5.08-9AWH  | 40.64          | 45.72  |
| 10           | 2EDG-5.08-10AWH | 45.72          | 50.80  |
| 11           | 2EDG-5.08-11AWH | 50.80          | 55.88  |
| 12           | 2EDG-5.08-12AWH | 55.88          | 60.96  |
| 13           | 2EDG-5.08-13AWH | 60.96          | 66.04  |
| 14           | 2EDG-5.08-14AWH | 66.04          | 71.12  |
| 15           | 2EDG-5.08-15AWH | 71.12          | 76.20  |
| ~            | ~               | ~              | ~      |
| 24           | 2EDG-5.08-24AWH | 116.84         | 121.92 |

|           |                        |                   |                   |                  |                                   |               |             |     |
|-----------|------------------------|-------------------|-------------------|------------------|-----------------------------------|---------------|-------------|-----|
|           |                        |                   | GENEERL TOLERANCE | 制图<br>DRAWING    | ZHE JIANG DELI CONNECTORS CO.,LTD |               |             |     |
|           |                        |                   | DIM TOL           | 审核<br>CHECK      |                                   |               |             |     |
|           |                        |                   | X.X ±0.50         | 批准<br>APPROVAL   | 产品名称<br>TITLE                     | 2EDG-5.08-AWH | 版本<br>REV.  | A   |
| 1         | 初版发行                   |                   | X.XX ±0.30        | 比例<br>SCALE      | 产品料号<br>PART NO.                  |               | 单位<br>UNITS | mm  |
| 序号<br>No. | 变更内容<br>MODIFY CONTENT | 日期<br>MODIFY DATE | X.XXX ±0.10       | 投影<br>Projection | 材料<br>MATERIAL                    |               | 页次<br>SHEET | 1/1 |
|           |                        |                   | Angle ±3.0°       |                  |                                   |               |             |     |



材料及电镀  
 ① 塑件主体: PA66, UL94V-0  
 ② 焊 针: 黄铜, 镀镍

电气性能  
 额定电压: 300V  
 额定电流: 15A  
 接触电阻: 20mΩ (Max)  
 绝缘电阻: 500MΩ \DC500V  
 耐 电 压: AC2000V\1min

机械性能  
 温度范围: -40℃ ~ +105℃  
 瞬时温度: +250℃ ,5秒

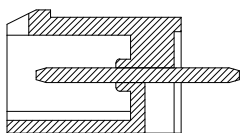

SECTION A-A

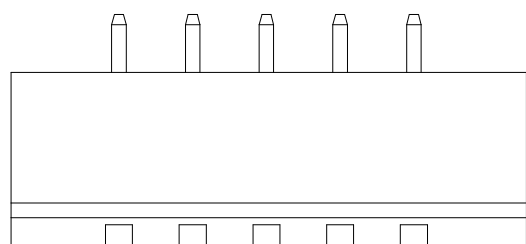
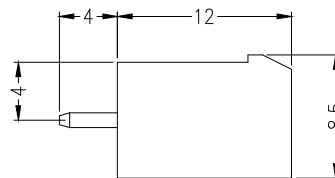

| Circuits | Product name    | Dimensino (mm) |        |
|----------|-----------------|----------------|--------|
|          |                 | A              | B      |
| 2        | 2EDG-5.08-2ALS  | 5.08           | 10.96  |
| 3        | 2EDG-5.08-3ALS  | 10.16          | 16.04  |
| 4        | 2EDG-5.08-4ALS  | 15.24          | 21.12  |
| 5        | 2EDG-5.08-5ALS  | 20.32          | 26.20  |
| 6        | 2EDG-5.08-6ALS  | 25.40          | 31.28  |
| 7        | 2EDG-5.08-7ALS  | 30.48          | 36.36  |
| 8        | 2EDG-5.08-8ALS  | 35.56          | 41.44  |
| 9        | 2EDG-5.08-9ALS  | 40.64          | 46.52  |
| 10       | 2EDG-5.08-10ALS | 45.72          | 51.60  |
| 11       | 2EDG-5.08-11ALS | 50.80          | 56.68  |
| 12       | 2EDG-5.08-12ALS | 55.88          | 61.76  |
| 13       | 2EDG-5.08-13ALS | 60.96          | 66.84  |
| 14       | 2EDG-5.08-14ALS | 66.04          | 71.92  |
| 15       | 2EDG-5.08-15ALS | 71.12          | 77.00  |
| ~        | ~               | ~              | ~      |
| 24       | 2EDG-5.08-24ALS | 116.84         | 122.72 |

|           |                        |                   | GENEERL TOLERANCE | 制 图<br>DRAWING    | ZHE JIANG DELI CONNECTORS CO ., LTD |               |              |     |
|-----------|------------------------|-------------------|-------------------|-------------------|-------------------------------------|---------------|--------------|-----|
|           |                        |                   | DIM TOL           | 审 核<br>CHECK      |                                     |               | 版 本<br>REV.  | A   |
|           |                        |                   | X.X ±0.50         | 批 准<br>APPROVAL   | 产品名称<br>TITLE                       | 2EDG-5.08-ALS | 单 位<br>UNITS | mm  |
| 1         | 初版发行                   |                   | X.XX ±0.30        | 比 例<br>SCALE      | 产品料号<br>PART NO.                    |               | 页 次<br>SHEET | 1/1 |
| 序号<br>No. | 变更内容<br>MODIFY CONTENT | 日期<br>MODIFY DATE | X.XXX ±0.10       | 投 影<br>Projection | 材 料<br>MATERIAL                     |               |              |     |
|           |                        |                   | Angle ±3.0°       |                   |                                     |               |              |     |



材料及电镀

- ①. 螺 丝: M2.5, 钢, 镀锌, 一字槽
- ②. 塑件主体: PA66, UL94V-0
- ③. 夹 子: 磷青铜, 镀镍
- ④. 方 盒: 黄铜, 镀镍
- ⑤. 塑件盖板: PA66, UL94V-0

电气性能

- 额定电压: 300V
- 额定电流: 15A
- 接触电阻: 20mΩ (Max)
- 绝缘电阻: 500MΩ \DC500V
- 耐 电 压: AC2000V\1min
- 使用线径: 28-14AWG 2.5mm<sup>2</sup>

机械性能

- 温度范围: -40℃ ~ +105℃
- 瞬时温度: +250℃ 5秒
- 扭 力: 0.5Nm (4.43Lbin)
- 剥线长度: 7-8mm

3 Pin以上

2 Pin

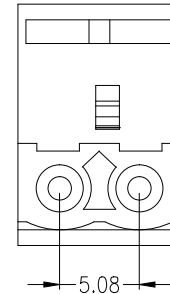
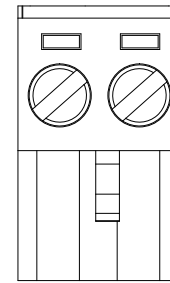
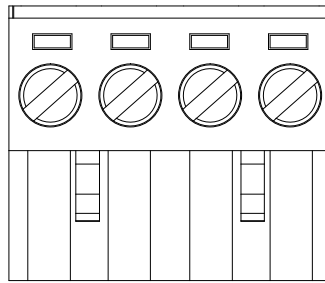

| Circuits | Product name  | Dimensino (mm) |        |
|----------|---------------|----------------|--------|
|          |               | A              | B      |
| 2        | 2EDG-5.08-2Y  | 5.08           | 10.96  |
| 3        | 2EDG-5.08-3Y  | 10.16          | 16.04  |
| 4        | 2EDG-5.08-4Y  | 15.24          | 21.12  |
| 5        | 2EDG-5.08-5Y  | 20.32          | 26.20  |
| 6        | 2EDG-5.08-6Y  | 25.40          | 31.28  |
| 7        | 2EDG-5.08-7Y  | 30.48          | 36.36  |
| 8        | 2EDG-5.08-8Y  | 35.56          | 41.44  |
| 9        | 2EDG-5.08-9Y  | 40.64          | 46.52  |
| 10       | 2EDG-5.08-10Y | 45.72          | 51.60  |
| 11       | 2EDG-5.08-11Y | 50.80          | 56.68  |
| 12       | 2EDG-5.08-12Y | 55.88          | 61.76  |
| 13       | 2EDG-5.08-13Y | 60.96          | 66.84  |
| 14       | 2EDG-5.08-14Y | 66.04          | 71.92  |
| 15       | 2EDG-5.08-15Y | 71.12          | 77.00  |
| ~        | ~             | ~              | ~      |
| 24       | 2EDG-5.08-24Y | 116.84         | 122.72 |

|           |                        |                   |                  |       |                   |  |                                    |             |  |              |     |
|-----------|------------------------|-------------------|------------------|-------|-------------------|--|------------------------------------|-------------|--|--------------|-----|
|           |                        |                   | GENEAL TOLERANCE |       | 制 图<br>DRAWING    |  | ZHE JIANG DELI CONNECTORS CO., LTD |             |  |              |     |
|           |                        |                   | DIM              | TOL   | 审 核<br>CHECK      |  |                                    |             |  |              |     |
|           |                        |                   | X.X              | ±0.50 | 批 准<br>APPROVAL   |  | 产品名称<br>TITLE                      | 2EDG-5.08-Y |  | 版本<br>REV.   | A   |
|           |                        |                   | X.XX             | ±0.30 | 比 例<br>SCALE      |  | 产品料号<br>PART NO.                   |             |  | 单 位<br>UNITS | mm  |
|           |                        |                   | X.XXX            | ±0.10 | 投 影<br>Projection |  | 材 料<br>MATERIAL                    |             |  | 页 次<br>SHEET | 1/1 |
|           |                        |                   | Angle            | ±3.0° |                   |  |                                    |             |  |              |     |
| 1         | 初版发行                   |                   |                  |       |                   |  |                                    |             |  |              |     |
| 序号<br>No. | 变更内容<br>MODIFY CONTENT | 日期<br>MODIFY DATE |                  |       |                   |  |                                    |             |  |              |     |





材料及电镀

- ①. 螺 丝: M2.5, 钢, 镀锌, 一字槽
- ②. 塑件主体: PA66, UL94V-0
- ③. 夹 子: 磷青铜, 镀镍
- ④. 方 盒: 黄铜, 镀镍
- ⑤. 塑件盖板: PA66, UL94V-0

电气性能  
 额定电压: 300V  
 额定电流: 15A  
 接触电阻: 20mΩ (Max)  
 绝缘电阻: 500MΩ \DC500V  
 耐 电 压: AC2000V\1Min  
 使用线径: 28-14AWG 2.5mm<sup>2</sup>

3 Pin以上

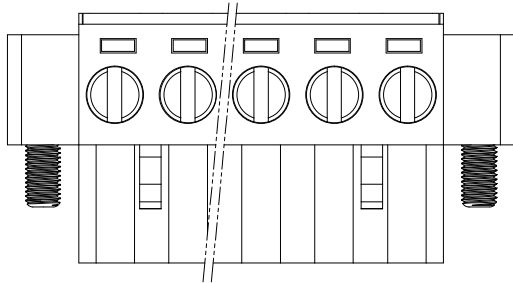

2 Pin

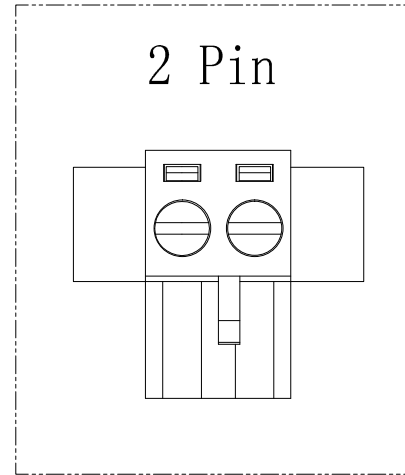

机械性能  
 温度范围: -40℃ ~ +105℃  
 瞬时温度: +250℃ 5秒  
 扭 力: 0.5Nm(4.43Lbin)  
 剥线长度: 7-8mm

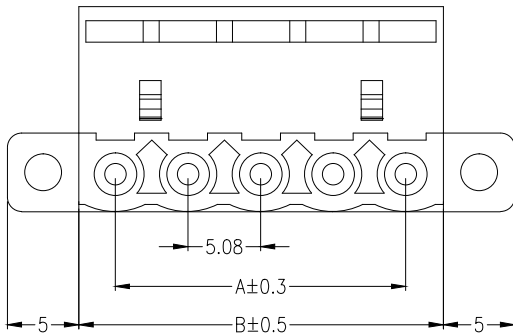
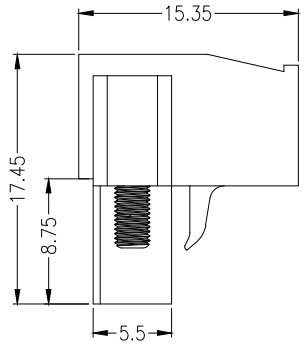

| Circuits | Product name    | Dimensino (mm) |        |
|----------|-----------------|----------------|--------|
|          |                 | A              | B      |
| 2        | 2EDG-5.08-2YLS  | 5.08           | 11.16  |
| 3        | 2EDG-5.08-3YLS  | 10.16          | 16.24  |
| 4        | 2EDG-5.08-4YLS  | 15.24          | 21.32  |
| 5        | 2EDG-5.08-5YLS  | 20.32          | 26.40  |
| 6        | 2EDG-5.08-6YLS  | 25.40          | 31.48  |
| 7        | 2EDG-5.08-7YLS  | 30.48          | 36.56  |
| 8        | 2EDG-5.08-8YLS  | 35.56          | 41.64  |
| 9        | 2EDG-5.08-9YLS  | 40.64          | 46.72  |
| 10       | 2EDG-5.08-10YLS | 45.72          | 51.80  |
| 11       | 2EDG-5.08-11YLS | 50.80          | 56.88  |
| 12       | 2EDG-5.08-12YLS | 55.88          | 61.96  |
| 13       | 2EDG-5.08-13YLS | 60.96          | 67.04  |
| 14       | 2EDG-5.08-14YLS | 66.04          | 72.12  |
| 15       | 2EDG-5.08-15YLS | 71.12          | 77.20  |
| ~        | ~               | ~              | ~      |
| 24       | 2EDG-5.08-24YLS | 116.84         | 122.92 |

|           |                        |                   |                  |       |                   |  |                                    |               |  |              |     |
|-----------|------------------------|-------------------|------------------|-------|-------------------|--|------------------------------------|---------------|--|--------------|-----|
|           |                        |                   | GENEAL TOLERANCE |       | 制 图<br>DRAWING    |  | ZHE JIANG DELI CONNECTORS CO., LTD |               |  |              |     |
|           |                        |                   | DIM              | TOL   | 审 核<br>CHECK      |  |                                    |               |  |              |     |
|           |                        |                   | X.X              | ±0.50 | 批 准<br>APPROVAL   |  | 产品名称<br>TITLE                      | 2EDG-5.08-YLS |  | 版本<br>REV.   | A   |
| 1         |                        |                   | 初版发行             |       | 比 例<br>SCALE      |  | 产品料号<br>PART NO.                   |               |  | 单 位<br>UNITS | mm  |
| 序号<br>No. | 变更内容<br>MODIFY CONTENT | 日期<br>MODIFY DATE | Angle ±3.0°      |       | 投 影<br>Projection |  | 材 料<br>MATERIAL                    |               |  | 页 次<br>SHEET | 1/1 |

## X-ON Electronics

Largest Supplier of Electrical and Electronic Components

*Click to view similar products for [Pluggable Terminal Blocks](#) category:*

*Click to view products by [DLL](#) manufacturer:*

Other Similar products are found below :

[57.510.0053](#) [721-104/026-047](#) [721-204/026-045](#) [MC 1.5/ 6-ST-3.5 GY AU](#) [ET02015000J0G](#) [860505](#) [860516](#) [860810](#) [GBPACX-12](#)  
[93.731.4953.0](#) [PVP03-3,50](#) [PVS02-5,00](#) [1-1986160-3](#) [1377680000](#) [1531000000](#) [1546228-5](#) [ELFP03110](#) [ELFP10210](#) [ELFT07250](#)  
[ELVD12100](#) [ELVF09400](#) [ELXH071G0E](#) [1725220000](#) [1760336](#) [1855000000](#) [19346](#) [1946309](#) [1973592](#) [19892](#) [25.320.4053.1](#) [25.320.4553.9](#)  
[25.320.4753.1](#) [25.320.5453.1](#) [25.340.0353.1](#) [25.340.1053.1](#) [25.345.3553.0M001](#) [25.640.3553.1](#) [SH02-5,08](#) [SH06-3,81](#) [SH08-5,08](#) [SH08-](#)  
[5,08-K](#) [SH12-5,08](#) [SHS04-5,00](#) [30.303](#) [30.305](#) [30.306](#) [PHP09-5,08](#) [25.193.0453.0](#) [25.320.4653.1](#) [25.332.2453.1](#)