

技术特性/Specifications:

额定电压 Rated voltage: 250V AC, DC
额定电流 Rated current: 5A AC, DC
接触电阻 Contact resistance: 20m Ω max
绝缘电阻 Insulation resistance: 1000M Ω min
耐压 Withstand voltage: 1500V AC/minute
环境温度 Ambient temperature: -40 $^{\circ}$ C~+105 $^{\circ}$ C
适用线规 Wire range: AWG#24~#18

REV.	REVISION DESCRIPTION	DATE

NORES :

1. Rated voltage: 250V AC.DC
2. Rated current: 5A AC DC
3. Contact resistance: $\leq 20 \text{ m}\Omega$
4. Insulation resistance: $\geq 1000 \text{ m}\Omega$
5. Withstand voltage: 1500V AC/minute
6. Ambient temprature: $-40^{\circ}\text{C} \sim 105^{\circ}\text{C}$
7. Materials: Nylon UL94V-0(2)
8. Matched RoHS criteria

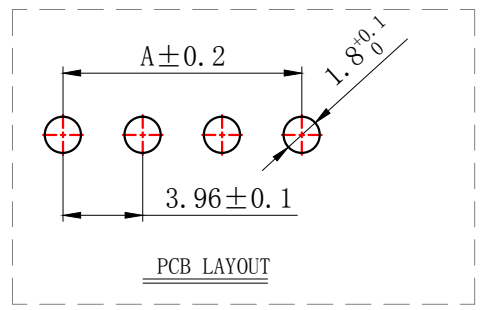
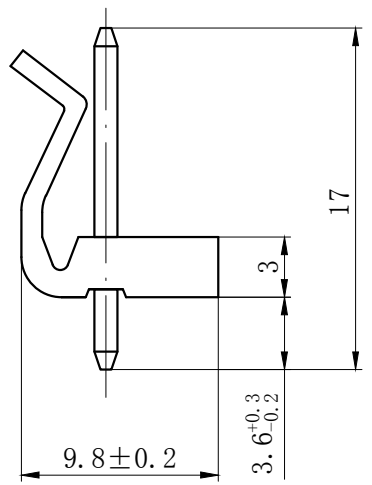
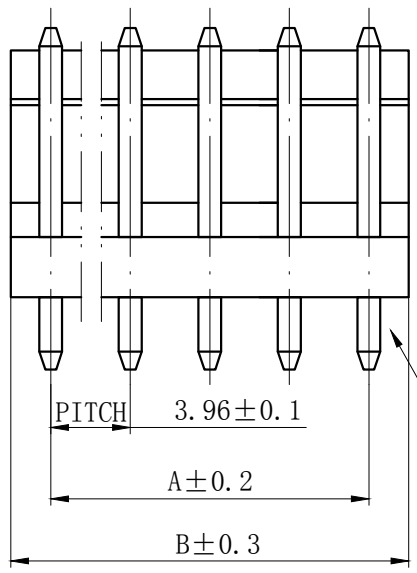
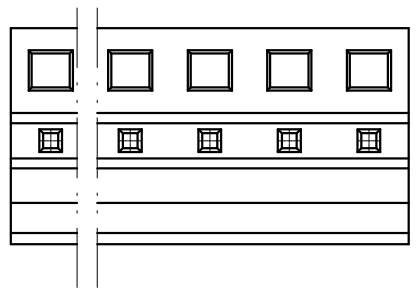

Circuits	Product name	Dimension mm	
		A	B
02	3.96-2A	3.96	7.92
03	3.96-3A	7.92	11.88
04	3.96-4A	11.88	15.84
05	3.96-5A	15.84	19.80
06	3.96-6A	19.80	23.76
07	3.96-7A	23.76	27.72
08	3.96-8A	27.72	31.68
09	3.96-9A	31.68	35.64
10	3.96-10A	35.64	39.60
11	3.96-11A	39.60	43.56
12	3.96-12A	43.56	47.52
13	3.96-13A	47.52	51.48
14	3.96-14A	51.48	55.44
15	3.96-15A	55.44	59.40

GENERAL TOLERANCES (UNLESS SPECIFIED)		ZHE JIANG DELI CONNECTORS CO., LTD	
.X: ± 0.25	X°: ± 3.0°	PRODUCT NAME:	TITLE: 3.96 mm Pitch Wire To Board Wafer
.XX: ± 0.15	.X°: ± 2.0°	DL39601(3.96)-A	
.XXX: ± 0.01	.XX°: ± 1.0°	DR: Yuan Jun Rong	DATE:19/08/01
FINISH:		CHKD: Wu Hui	DATE:19/08/01
DRAWING NO:		APPD:Ren An De	DATE:19/08/01
		SCALE: N/A	PAGE: 1/1
		UNITS: mm	REV.: A

REV.	REVISION DESCRIPTION	DATE

NORES:

1. Rated voltage: 250V AC.DC
2. Rated current: 5A AC DC
3. Contact resistance: $\leq 20 \text{ m}\Omega$
4. Insulation resistance: $\geq 1000 \text{ m}\Omega$
5. Withstand voltage: 1500V AC/minute
6. Ambient temperature: $-40^{\circ}\text{C} \sim 105^{\circ}\text{C}$
7. Materials: Nylon UL94V-0 (2)
8. Matched RoHS criteria

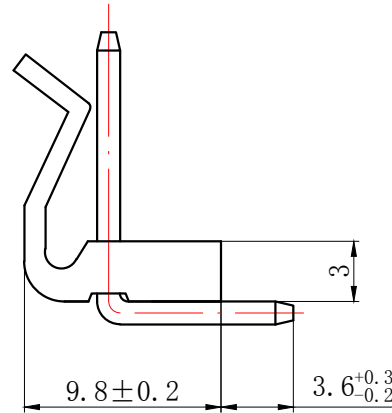
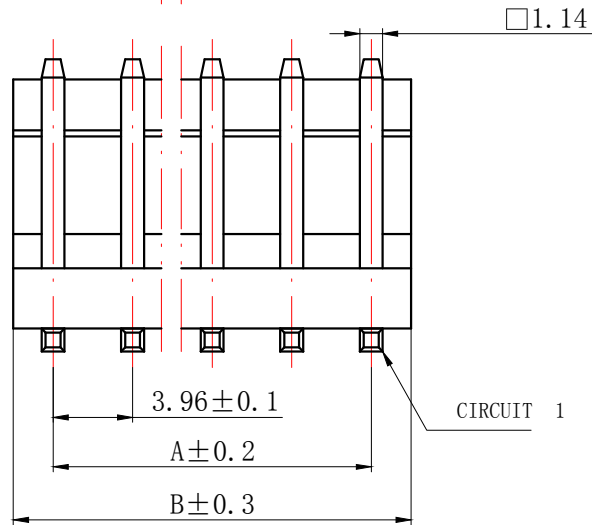
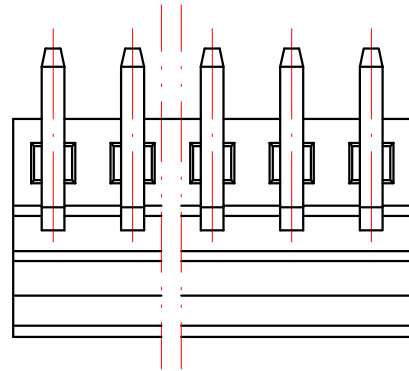

Circuits	Product name	Dimension mm	
		A	B
02	3.96-2AW	3.96	7.92
03	3.96-3AW	7.92	11.88
04	3.96-4AW	11.88	15.84
05	3.96-5AW	15.84	19.80
06	3.96-6AW	19.80	23.76
07	3.96-7AW	23.76	27.72
08	3.96-8AW	27.72	31.68
09	3.96-9AW	31.68	35.64
10	3.96-10AW	35.64	39.60
11	3.96-11AW	39.60	43.56
12	3.96-12AW	43.56	47.52
13	3.96-13AW	47.52	51.48
14	3.96-14AW	51.48	55.44
15	3.96-15AW	55.44	59.40

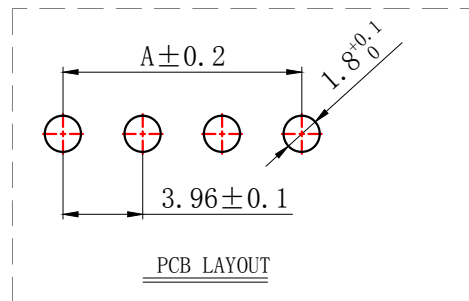

GENERAL TOLERANCES (UNLESS SPECIFIED)		ZHE JIANG DELI CONNECTORS CO., LTD	
.X: ± 0.25	X°: ± 3.0°	PRODUCT NAME:	TITLE: 3.96 mm Pitch Wire To Board Wafer
.XX: ± 0.15	.X°: ± 2.0°	DL39601 (3.96)-AW	
.XXX: ± 0.01	.XX°: ± 1.0°	DR: Yuan Jun Rong	DATE: 19/08/01
FINISH:		CHKD: Wu Hui	DATE: 19/08/01
DRAWING NO:		APPD: Ren An De	DATE: 19/08/01
		PART NO:	SCALE: N/A
			PAGE: 1/1
		UNITS: mm	REV.: A

REV.	REVISION DESCRIPTION	DATE

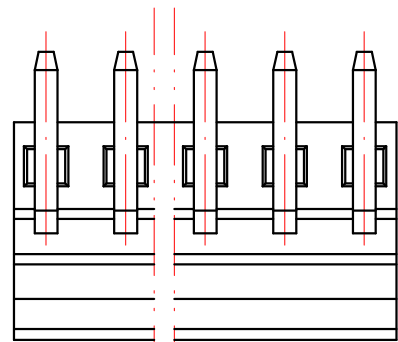

□1.14

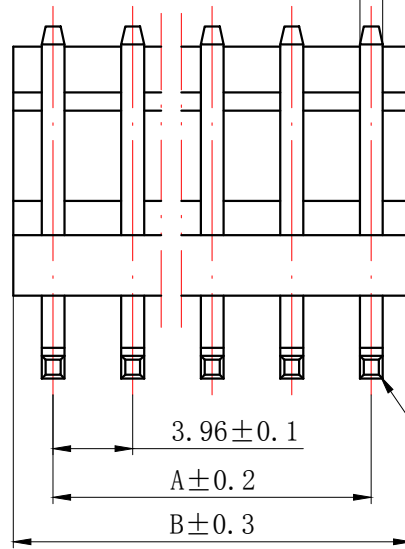

CIRCUIT 1

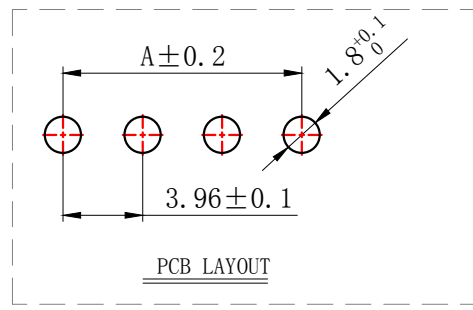
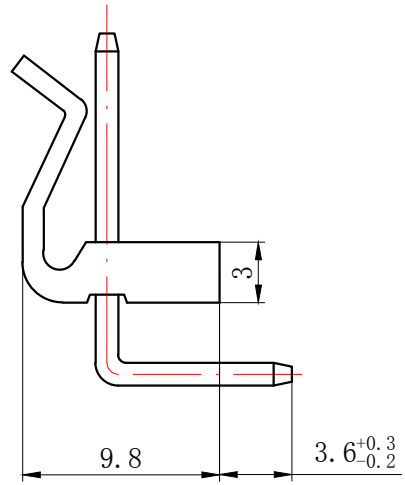

PCB LAYOUT

NORES:

1. Rated voltage: 250V AC/DC
2. Rated current: 5A AC/DC
3. Contact resistance: $\leq 20 \text{ m}\Omega$
4. Insulation resistance: $\geq 1000 \text{ m}\Omega$
5. Withstand voltage: 1500V AC/minute
6. Ambient temperature: $-40^{\circ}\text{C} \sim 105^{\circ}\text{C}$
7. Materials: Nylon UL94V-0(2)
8. Matched RoHS criteria

Circuits	Product name	Dimension mm	
		A	B
02	3.96-2AWT	3.96	7.92
03	3.96-3AWT	7.92	11.88
04	3.96-4AWT	11.88	15.84
05	3.96-5AWT	15.84	19.80
06	3.96-6AWT	19.80	23.76
07	3.96-7AWT	23.76	27.72
08	3.96-8AWT	27.72	31.68
09	3.96-9AWT	31.68	35.64
10	3.96-10AWT	35.64	39.60
11	3.96-11AWT	39.60	43.56
12	3.96-12AWT	43.56	47.52
13	3.96-13AWT	47.52	51.48
14	3.96-14AWT	51.48	55.44
15	3.96-15AWT	55.44	59.40

GENERAL TOLERANCES (UNLESS SPECIFIED)		ZHE JIANG DELI CONNECTORS CO., LTD	
.X: ± 0.25	.X°: $\pm 3.0^{\circ}$	PRODUCT NAME:	TITLE: 3.96 mm Pitch Wire To Board Wafer
.XX: ± 0.15	.X°: $\pm 2.0^{\circ}$	DL39601(3.96)-AWT	
.XXX: ± 0.01	.XX°: $\pm 1.0^{\circ}$	DR: Chen Quan Long	DATE:09/08/01
FINISH:		CHKD: Wu Hui	DATE:09/08/01
DRAWING NO:		APPD: Ren An De	DATE:09/08/01
		SCALE: N/A	PAGE: 1/1
		UNITS: mm	REV.: A

REV.	REVISION DESCRIPTION	DATE

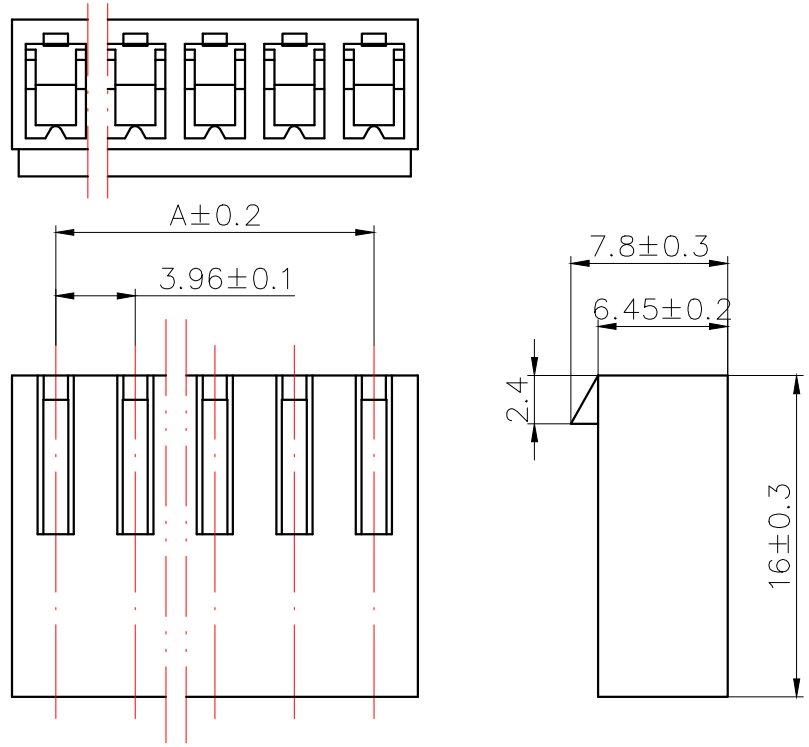

NORES :

1. Rated voltage: 250V AC.DC
2. Rated current: 5A AC DC
3. Contact resistance: ≤ 20 m Ω
4. Insulation resistance: ≥ 1000 m Ω
5. Withstand voltage: 1500V AC/minute
6. Ambient temprature: $-10^{\circ}\text{C} \sim 105^{\circ}\text{C}$
7. Materials: Nylon UL94V-0 (2)
8. Matched RoHS criteria

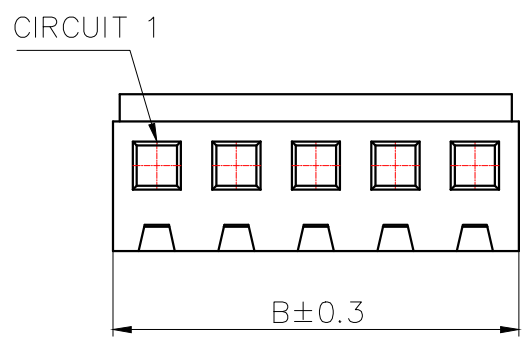

Circuits	Product name	Dimension mm	
		A	B
02	3.96-2Y	3.96	8.32
03	3.96-3Y	7.92	12.28
04	3.96-4Y	11.88	16.24
05	3.96-5Y	15.84	20.20
06	3.96-6Y	19.80	24.16
07	3.96-7Y	23.76	28.12
08	3.96-8Y	27.72	32.08
09	3.96-9Y	31.68	36.04
10	3.96-10Y	35.64	40.00
11	3.96-11Y	39.60	43.96
12	3.96-12Y	43.56	47.92
13	3.96-13Y	47.52	51.88
14	3.96-14Y	51.48	55.84
15	3.96-15Y	55.44	59.80

GENERAL TOLERANCES (UNLESS SPECIFIED)		ZHE JIANG DELI CONNECTORS CO., LTD	
.X: ± 0.25	X°: $\pm 3.0^{\circ}$	PRODUCT NAME: DL39601 (3.96)-Y	TITLE: 3.96 mm Pitch Wire To Board Wafer
.XX: ± 0.15	.X°: $\pm 2.0^{\circ}$	DR: Yuan Jun Rong	DATE: 09/08/01
.XXX: ± 0.01	.XX°: $\pm 1.0^{\circ}$	CHKD: Wu Hui	DATE: 09/08/01
FINISH:		APPD: Ren An De	DATE: 09/08/01
DRAWING NO:		SCALE: N/A	PAGE: 1/1
		UNITS: mm	REV.: A

REV.	REVISION DESCRIPTION	DATE	APPD
B	端子高度尺寸更新	19.4.20	Wu
C	端子倒勾宽度	19.10.12	Wu



NOTES

Used in DL39601-Y Series Housing.
 Accepts AWG #24~18 Wire Range.
 0.33~ 0.83 mm² .
 Insulation O.D. =1.7~3.0 mm.
 Material : Phosphor Bronze .
 Finish: Tin plated.
 Thickness: 0.25 mm.

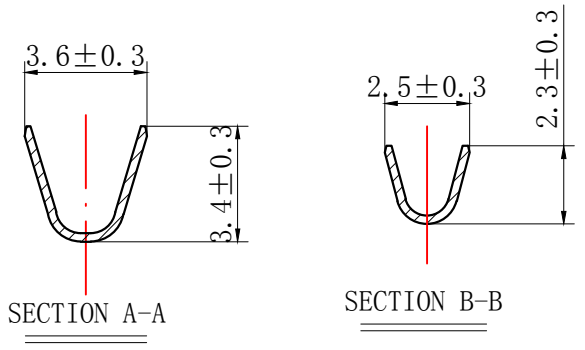

GENERAL TOLERANCES (UNLESS SPECIFIED)		ZHE JIANG DELI CONNECTORS CO., LTD	
.X: ± 0.25	X° : ± 3.0°	PRODUCT NAME: DL39601 (3.96)-T	TITLE: 3.96 mm pitch WTB Crimping Terminal
.XX: ± 0.15	.X° : ± 2.0°	DR: Xian Qiang	DATE: 16.3.3
.XXX: ± 0.01	.XX° : ± 1.0°	CHKD: Liu Bing	DATE: 16.3.3
DRAWING NO:		APPD: Liu Bing	DATE: 16.3.3
		SCALE: N/A	PAGE: 1/1
		UNITS: mm	REV.: C

X-ON Electronics

Largest Supplier of Electrical and Electronic Components

Click to view similar products for [Headers & Wire Housings](#) category:

Click to view products by [DLL](#) manufacturer:

Other Similar products are found below :

[0015917161](#) [0022155065](#) [57102-F02-18ULF](#) [58102-G61-06LF](#) [582553-1](#) [01.001.5753.1](#) [0050291907](#) [02.125.8002.8](#) [609-3404](#) [61062-3](#)
[CSU011177004](#) [622-0430](#) [622-3653LF](#) [63453-116](#) [636-1030](#) [636-1427](#) [636-3427](#) [636-4007](#) [641938-9](#) [65495-038](#) [65692-001LF](#) [65781-018](#)
[65781-047](#) [65817-010LF](#) [65817-015LF](#) [67095-007LF](#) [67601157](#) [68631-112](#) [68645-018](#) [699319-000](#) [70.362.1628.0](#) [70-4210](#) [70-4226B](#) [70-](#)
[4853B](#) [71.350.2428.0](#) [733-134](#) [733-162](#) [760-3052](#) [MHR-64-VUAL](#) [80.063.4001.1](#) [800-90-001-10-001000](#) [801-43-002-10-013000](#)
[801-43-006-10-002000](#) [803-43-024-10-001000](#) [803-93-012-10-001000](#) [8-1437020-4](#) [819-22-004-30-001101](#) [820-22-006-30-001101](#)
[820-22-008-30-001101](#) [821-22-002-10-001101](#)