

技术特性/Specifications:

额定电压 Rated voltage: 300V AC, DC
额定电流 Rated current: 9A AC, DC
接触电阻 Contact resistance: 20m Ω max
绝缘电阻 Insulation resistance: 1000M Ω min
耐压 Withstand voltage: 1500V AC/minute
环境温度 Ambient temperature: -40 $^{\circ}$ C~+105 $^{\circ}$ C
适用线规 Wire range: AWG#28~#14

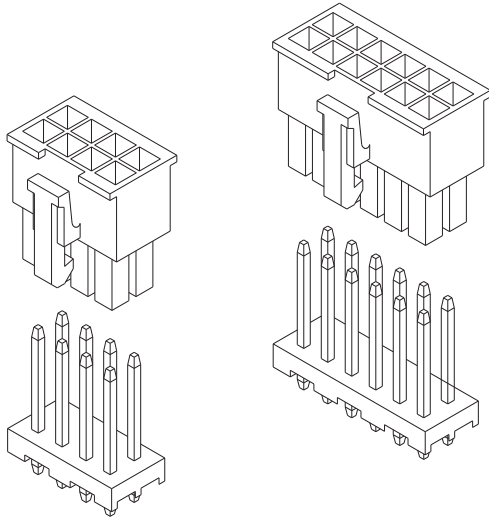

REV.	REVISION DESCRIPTION	DATE	APPD

NOTES:

- 1、Rated voltage: 300V AC.DC
 - 2、Rated current: 9A AC.DC
 - 3、Contact resistance: $\leq 20 \text{ m}\Omega$
 - 4、Insulation resistance: $\geq 1000 \text{ M}\Omega$
 - 5、Withstand voltage : 1500V AC/minute
 - 6、Ambient temperature: $-25^{\circ}\text{C} \sim 85^{\circ}\text{C}$
- Green Material RoHS Compliant

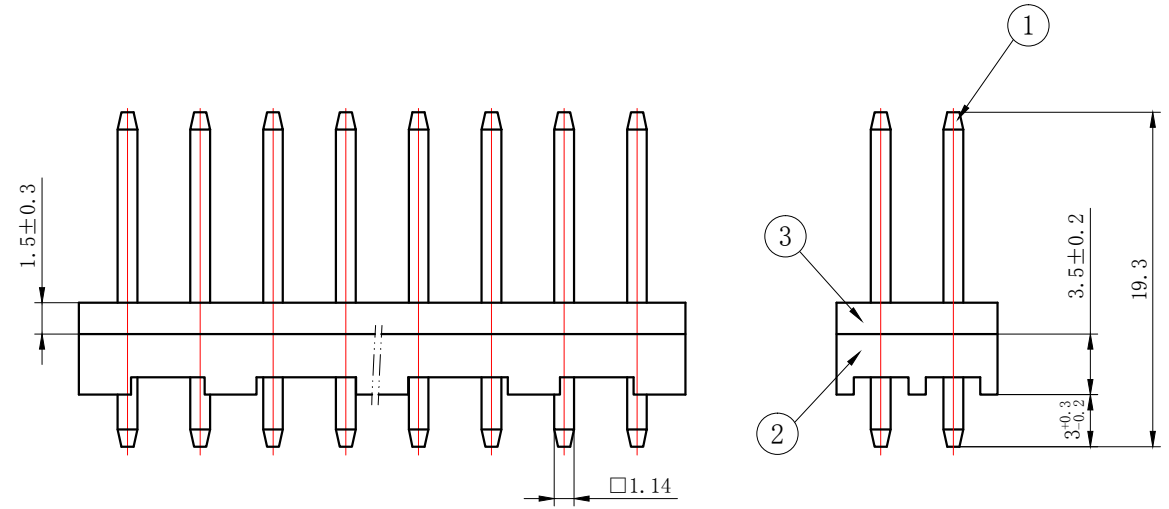
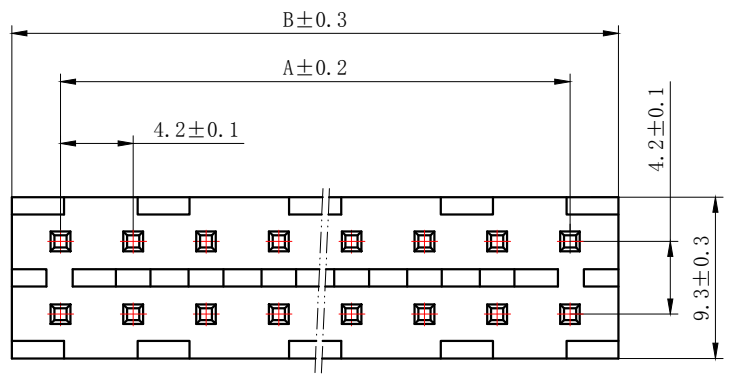

3	③	密封垫	硅胶	1	UL94-V2
2	②	基座	PA66/PBT	1	UL94-V0
1	①	接触件	黄铜	N*	镀锡
序号	图号	名称	材料	数量	附件

Circuits	Product name	Dimension mm		Circuits	Product name	Dimension mm	
		A	B			A	B
2X2	4.2-4A-11	4.2	9.8	2X8	4.2-16A-11	29.4	35.0
2X3	4.2-6A-11	8.4	14.0	2X9	4.2-18A-11	33.6	39.2
2X4	4.2-8A-11	12.6	18.2	2X10	4.2-20A-11	37.8	43.4
2X5	4.2-10A-11	16.8	22.4	2X11	4.2-22A-11	42.0	47.6
2X6	4.2-11A-11	21.0	26.6	~	~	~	~
2X7	4.2-14A-11	25.2	30.8	2X15	4.2-30A-11	60.0	64.4

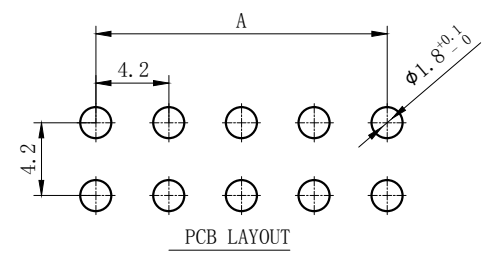

GENERAL TOLERANCES (UNLESS SPECIFIED)		ZHEJIANG DELI CONNECTORS CO., LTD			
.X: ± 0.25	X°: ± 3.0°	PRODUCT NAME: DL42006(4.2)-A-11		TITLE: 4.20 mm Pitch Wire To Board Wafer	
.XX: ± 0.15	.X°: ± 2.0°	DR: Chen Quan Long	DATE: 21/11/24	PART NO:	
.XXX: ± 0.01	.XX°: ± 1.0°	CHKD: Wu Hui	DATE: 21/11/24	SCALE: N/A	PAGE: 1/1
DRAWING NO:		APPD: Ren An De	DATE: 21/11/24	UNITS: mm	REV.: A

REV.	REVISION DESCRIPTION	DATE	APPD

NOTES:

- 1、Rated voltage: 300V AC.DC
 - 2、Rated current: 9A AC.DC
 - 3、Contact resistance: $\leq 20 \text{ m}\Omega$
 - 4、Insulation resistance: $\geq 1000 \text{ M}\Omega$
 - 5、Withstand voltage : 1500V AC/minute
 - 6、Ambient temperature: $-25^{\circ}\text{C} \sim 85^{\circ}\text{C}$
- Green Material RoHS Compliant

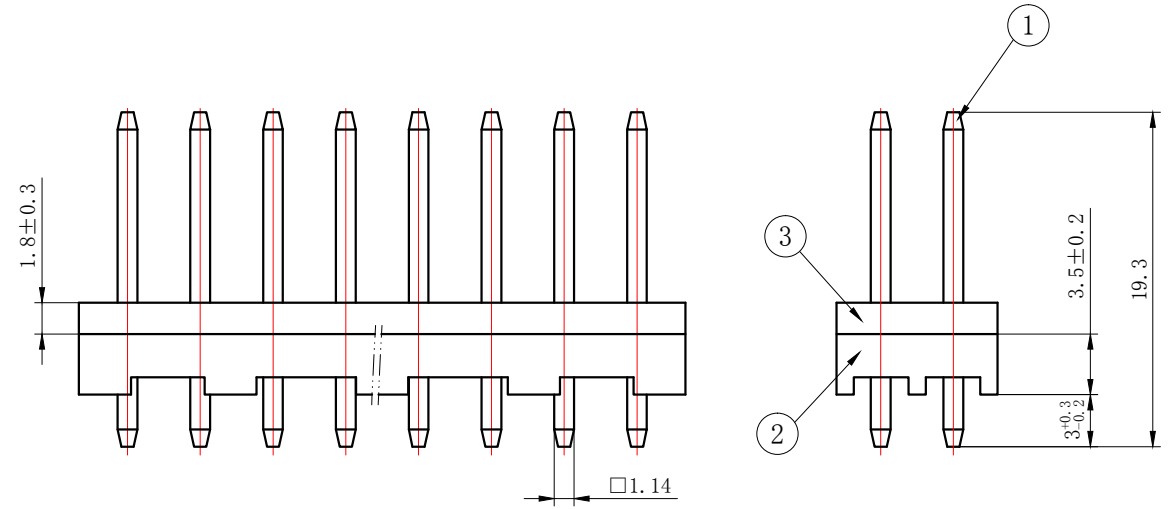
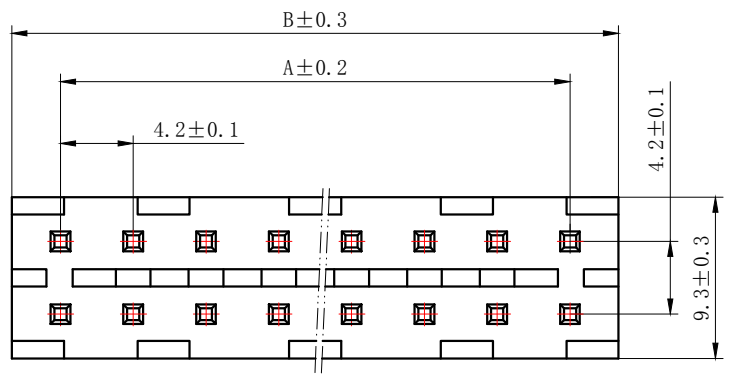

序号	图号	名称	材料	数量	附件
3	③	密封垫	硅胶	1	UL94-V2
2	②	基座	PA66/PBT	1	UL94-V0
1	①	接触件	黄铜	N*	镀锡

Circuits	Product name	Dimension mm		Circuits	Product name	Dimension mm	
		A	B			A	B
2X2	4.2-4A-12	4.2	9.8	2X8	4.2-16A-12	29.4	35.0
2X3	4.2-6A-12	8.4	14.0	2X9	4.2-18A-12	33.6	39.2
2X4	4.2-8A-12	12.6	18.2	2X10	4.2-20A-12	37.8	43.4
2X5	4.2-10A-12	16.8	22.4	2X11	4.2-22A-12	42.0	47.6
2X6	4.2-12A-12	21.0	26.6	~	~	~	~
2X7	4.2-14A-12	25.2	30.8	2X15	4.2-30A-12	60.0	64.4

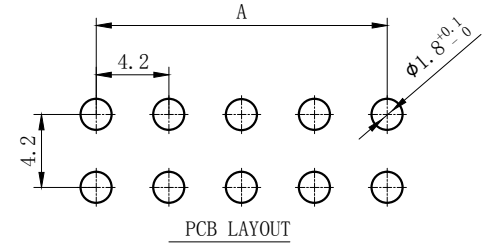

GENERAL TOLERANCES (UNLESS SPECIFIED)		ZHEJIANG DELI CONNECTORS CO., LTD			
.X: ± 0.25	X°: ± 3.0°	PRODUCT NAME: DL42006(4.2)-A-12		TITLE: 4.20 mm Pitch Wire To Board Wafer	
.XX: ± 0.15	.X°: ± 2.0°	DR:Chen Quan Long		DATE:21/11/24	
.XXX: ± 0.01	.XX°: ± 1.0°	CHKD:Wu Hui		DATE:21/11/24	
FINISH:		APPD:Ren An De		SCALE: N/A	PAGE: 1/1
DRAWING NO:		DATE:21/11/24		UNITS: mm	REV.: A

REV.	REVISION DESCRIPTION	DATE	APPD

NOTES:

- 1、Rated voltage: 300V AC.DC
 - 2、Rated current: 9A AC.DC
 - 3、Contact resistance: $\leq 20 \text{ m}\Omega$
 - 4、Insulation resistance: $\geq 1000 \text{ M}\Omega$
 - 5、Withstand voltage : 1500V AC/minute
 - 6、Ambient temperature: $-25^{\circ}\text{C} \sim 85^{\circ}\text{C}$
- Green Material RoHS Compliant

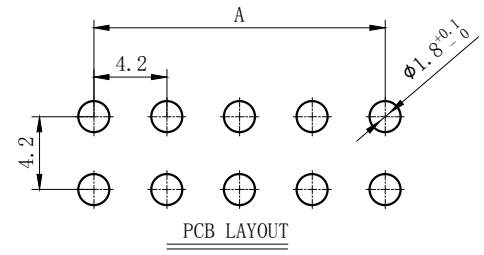
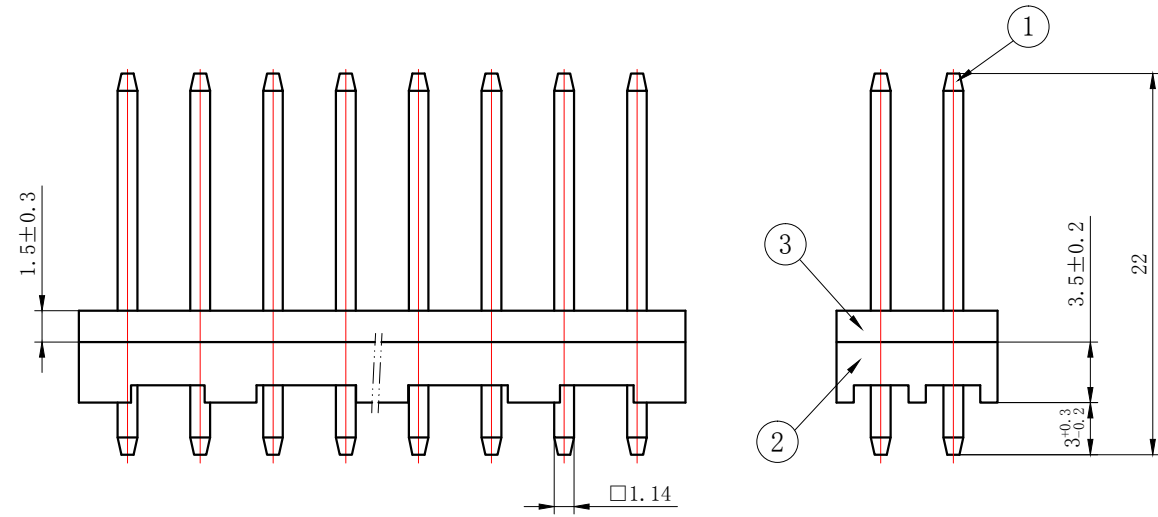
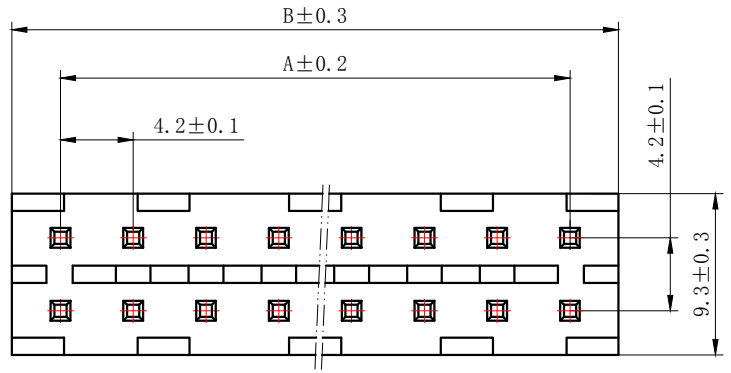

3	③	密封垫	硅胶	1	UL94-V2
2	②	基座	PA66/PBT	1	UL94-V0
1	①	接触件	黄铜	N*	镀锡
序号	图号	名称	材料	数量	附件

Circuits	Product name	Dimension mm		Circuits	Product name	Dimension mm	
		A	B			A	B
2X2	4.2-4A-21	4.2	9.8	2X8	4.2-16A-21	29.4	35.0
2X3	4.2-6A-21	8.4	14.0	2X9	4.2-18A-21	33.6	39.2
2X4	4.2-8A-21	12.6	18.2	2X10	4.2-20A-21	37.8	43.4
2X5	4.2-10A-21	16.8	22.4	2X11	4.2-22A-21	42.0	47.6
2X6	4.2-21A-21	21.0	26.6	~	~	~	~
2X7	4.2-14A-21	25.2	30.8	2X15	4.2-30A-21	60.0	64.4

GENERAL TOLERANCES (UNLESS SPECIFIED)		ZHEJIANG DELI CONNECTORS CO., LTD			
.X: ± 0.25	X°: $\pm 3.0^{\circ}$	PRODUCT NAME: DL42006(4.2)-A-21		TITLE: 4.20 mm Pitch Wire To Board Wafer	
.XX: ± 0.15	.X°: $\pm 2.0^{\circ}$	DR: Chen Quan Long	DATE: 21/11/24	PART NO:	
.XXX: ± 0.01	.XX°: $\pm 1.0^{\circ}$	CHKD: Wu Hui	DATE: 21/11/24	SCALE: N/A	PAGE: 1/1
DRAWING NO:		APPD: Ren An De	DATE: 21/11/24	UNITS: mm	REV.: A

REV.	REVISION DESCRIPTION	DATE	APPD

NOTES:

- 1、Rated voltage: 300V AC.DC
 - 2、Rated current: 9A AC.DC
 - 3、Contact resistance: $\leq 20 \text{ m}\Omega$
 - 4、Insulation resistance: $\geq 1000 \text{ M}\Omega$
 - 5、Withstand voltage : 1500V AC/minute
 - 6、Ambient temperature: $-25^{\circ}\text{C} \sim 85^{\circ}\text{C}$
- Green Material RoHS Compliant

A
B
C
D
E
F

A
B
C
D
E
F

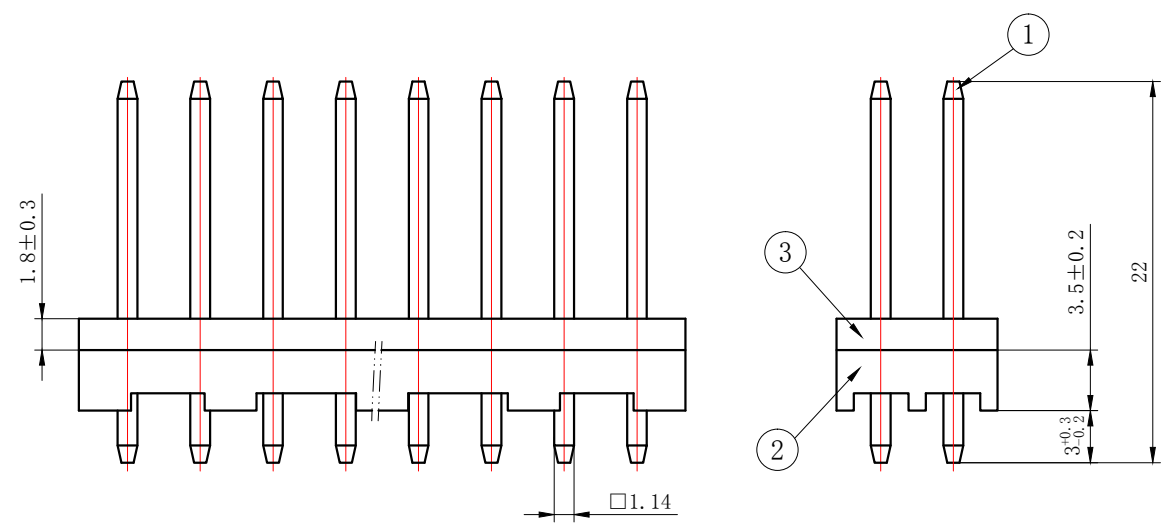
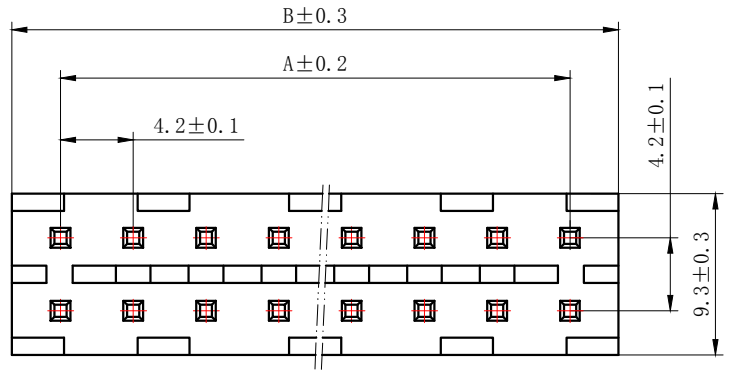

序号	图号	名称	材料	数量	附件
3	③	密封垫	硅胶	1	UL94-V2
2	②	基座	PA66/PBT	1	UL94-V0
1	①	接触件	黄铜	N*	镀锡

Circuits	Product name	Dimension mm		Circuits	Product name	Dimension mm	
		A	B			A	B
2X2	4.2-4A-22	4.2	9.8	2X8	4.2-16A-22	29.4	35.0
2X3	4.2-6A-22	8.4	14.0	2X9	4.2-18A-22	33.6	39.2
2X4	4.2-8A-22	12.6	18.2	2X10	4.2-20A-22	37.8	43.4
2X5	4.2-10A-22	16.8	22.4	2X11	4.2-22A-22	42.0	47.6
2X6	4.2-22A-22	21.0	26.6	~	~	~	~
2X7	4.2-14A-22	25.2	30.8	2X15	4.2-30A-22	60.0	64.4

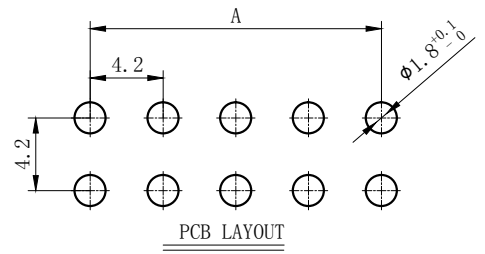

GENERAL TOLERANCES (UNLESS SPECIFIED)		ZHEJIANG DELI CONNECTORS CO., LTD			
.X: ± 0.25	X°: ± 3.0°	PRODUCT NAME: DL42006(4.2)-A-22		TITLE: 4.20 mm Pitch Wire To Board Wafer	
.XX: ± 0.15	.X°: ± 2.0°	DR: Chen Quan Long	DATE: 21/11/24	PART NO:	
.XXX: ± 0.01	.XX°: ± 1.0°	CHKD: Wu Hui	DATE: 21/11/24	SCALE: N/A	PAGE: 1/1
DRAWING NO:		APPD: Ren An De	DATE: 21/11/24	UNITS: mm	REV.: A

1 2 3 4 5 6 7 8

REV.	REVISION DESCRIPTION	DATE	APPD
A	19.9调整为20	3.24	刘
B	整体公差优化, 挂勾结构优化	20.5.20	Wu

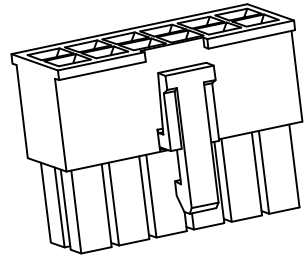
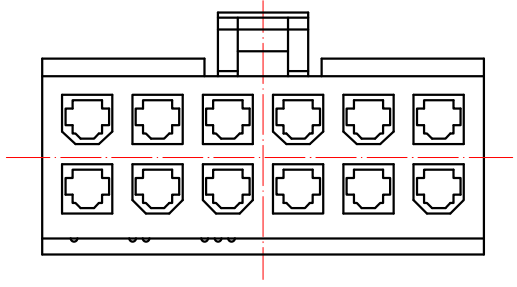

NOTES

Available in 02 through 24 Circuits.

Match with DL42002/DL42003/
DL42004 series housing

Material : Nylon UL94V-0(2).

Accepts DL42002-T Crimp Terminal.

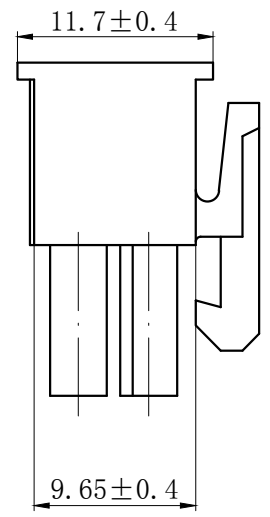
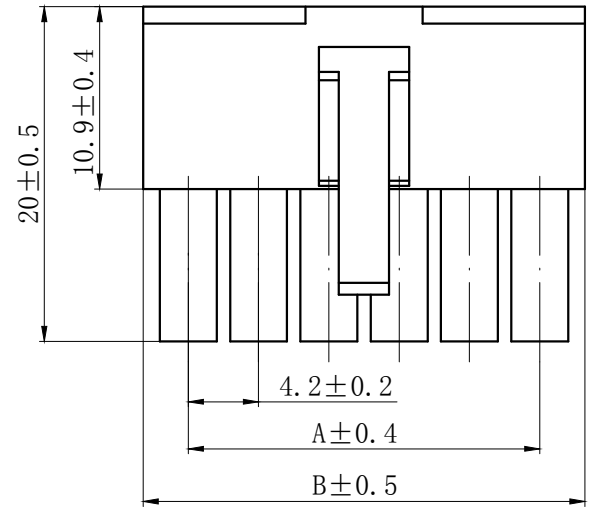

04-24 PIN

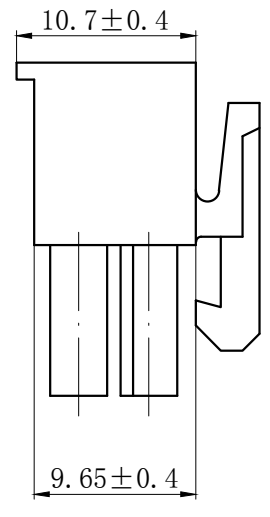

02PIN

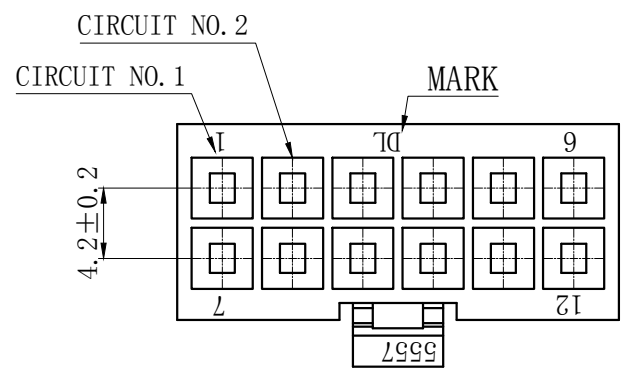

Circuits	Product name	Dimension mm		Circuits	Product name	Dimension mm	
		A	B			A	B
2x1	DL-5557-2Y	--	5.4	2x7	DL-5557-14Y	25.2	30.6
2x2	DL-5557-4Y	4.2	9.6	2x8	DL-5557-16Y	29.4	34.8
2x3	DL-5557-6Y	8.4	13.8	2x9	DL-5557-18Y	33.6	39.0
2x4	DL-5557-8Y	12.6	18.0	2x10	DL-5557-20Y	37.8	43.2
2x5	DL-5557-10Y	16.8	22.2	2x11	DL-5557-22Y	42.0	47.4
2x6	DL-5557-12Y	21.0	26.4	2x12	DL-5557-24Y	46.2	51.6

GENERAL TOLERANCES (UNLESS SPECIFIED)		ZHE JIANG DELI CONNECTORS CO., LTD	
.X: ± 0.25	X°: ± 3.0°	PRODUCT NAME:	TITLE:
.XX: ± 0.15	.X°: ± 2.0°	DL42002 (DLL-5557) -Y	4.2mm Pitch Housing
.XXX: ± 0.01	.XX°: ± 1.0°	DR: Chen Quan Long	DATE:21/08/01
FINISH:		CHKD: Wu Hui	DATE:21/08/01
DRAWING NO:		APPD:Ren An De	DATE:21/08/01
			PART NO:
			SCALE: N/A
			PAGE: 1/2
			UNITS: mm
			REV.: B

REV.	REVISION DESCRIPTION	DATE	APPD

NOTES

Available in 02 through 24 Circuits.

Match with DL42004 series housing

Material : Nylon UL94V-0(2).

Accepts DL42002-T Crimp Terminal.

4	④	防水垫	SILICON RUBBER	1
3	③	防水垫	SILICON RUBBER	1
2	②	线扣	Nylon UL94V-0(2)	1
1	①	底座	Nylon UL94V-0	1
序号	图号	名称	材料	数量

Circuits	Product name	Dimension mm		Circuits	Product name	Dimension mm	
		A	B			A	B
2x1	DLL-5557-2Y-FS	--	8.0	2x7	DLL-5557-14Y-FS	25.2	33.2
2x2	DLL-5557-4Y-FS	4.2	12.2	2x8	DLL-5557-16Y-FS	29.4	37.4
2x3	DLL-5557-6-FS	8.4	16.4	2x9	DLL-5557-18Y-FS	33.6	41.6
2x4	DLL-5557-8Y-FS	12.6	20.6	2x10	DLL-5557-20Y-FS	37.8	45.8
2x5	DLL-5557-10Y-FS	16.8	24.8	2x11	DLL-5557-22Y-FS	42.0	50.0
2x6	DLL-5557-12Y-FS	21.0	29.0	2x12	DLL-5557-24Y-FS	46.2	54.2

GENERAL TOLERANCES (UNLESS SPECIFIED)		ZHE JIANG DELI CONNECTORS CO., LTD	
.X: ± 0.25	X°: ± 3.0°	PRODUCT NAME: DL42012-Y-FS (DLL-5557-Y-FS)	TITLE: 4.2mm Pitch Housing
.XX: ± 0.15	.X°: ± 2.0°	DR: Chen Quan Long	DATE:21/08/01
.XXX: ± 0.01	.XX°: ± 1.0°	CHKD: Wu Hui	DATE:21/08/01
FINISH:		APPD: Ren An De	DATE:21/08/01
DRAWING NO:		SCALE: N/A	PAGE: 1/2
		UNITS: mm	REV.: B

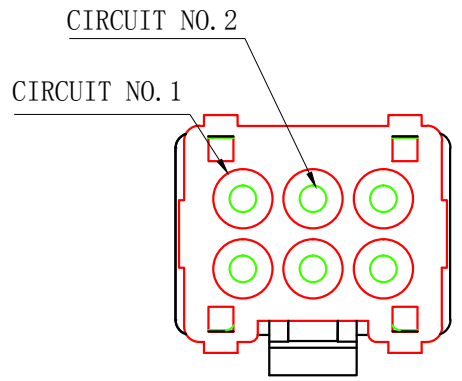
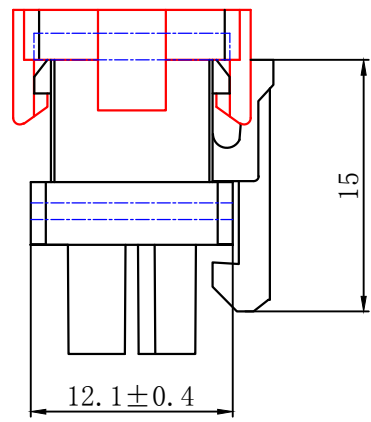
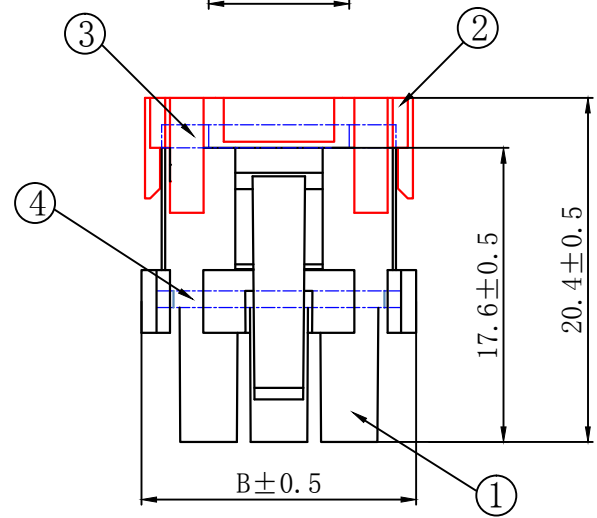
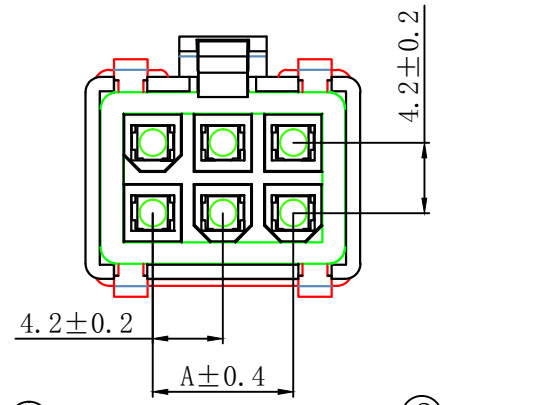

REV.	REVISION DESCRIPTION	DATE	APPD
B	2.6改2.9	2016.6.27	Wuhui
C	倒翅结构改为撕破式	2023.9.19	Wuhui

NOTES

Used in DL42002-Y Series Housing.

Accepts AWG #24~18 Wire Range.

Insulation O.D.=1.4~2.8mm.

Material : Phosphor Bronze .

Finish: Tin plated.

Thickness: 0.2 mm.

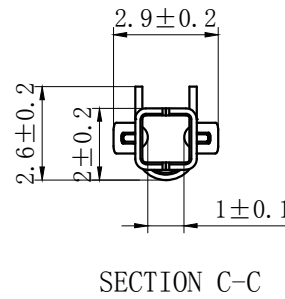
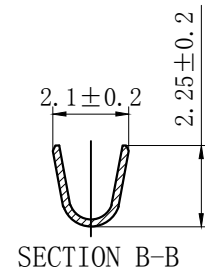
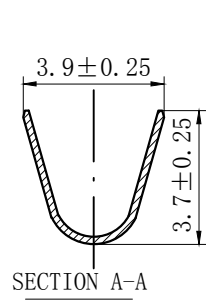
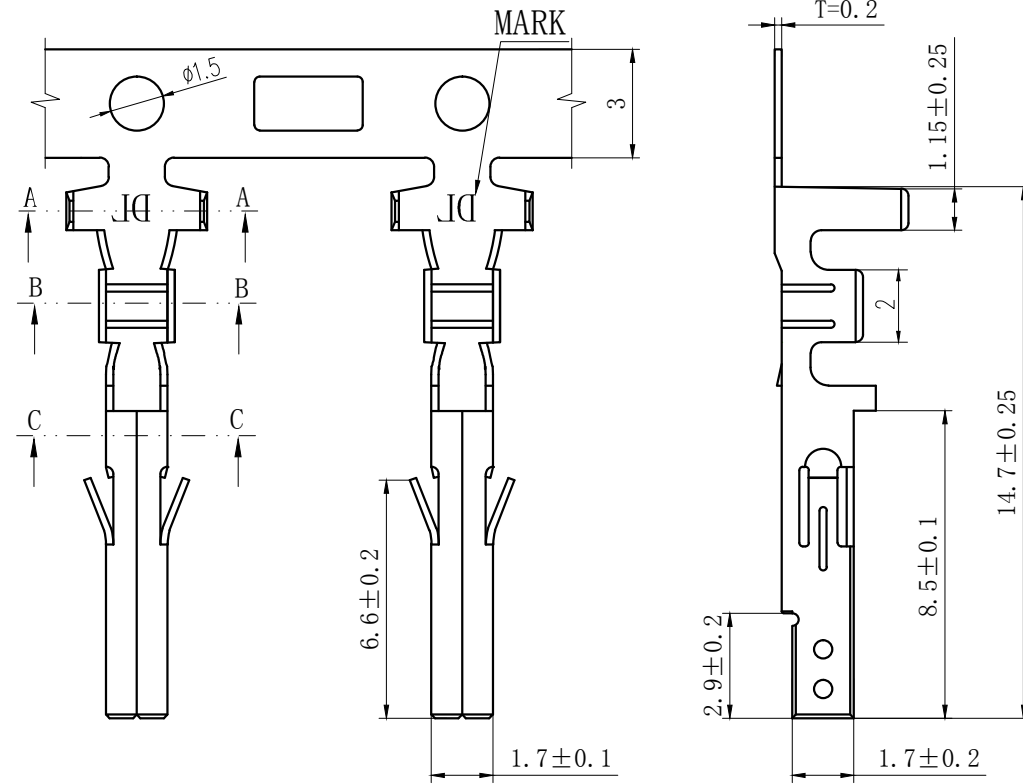

GENERAL TOLERANCES (UNLESS SPECIFIED)		ZHE JIANG DELI CONNECTORS CO., LTD	
.X: ± 0.25	X° : ± 3.0°	PRODUCT NAME:	TITLE: 4.20 mm Pitch Crimp Terminal
.XX: ± 0.15	.X° : ± 2.0°	DL42002 (DLL-5556)-T	PART NO:
.XXX: ± 0.01	.XX° : ± 1.0°	DR: Chen Quan Long	DATE: 2021/9/27
FINISH:		CHKD: Wu Hui	DATE: 2021/9/27
DRAWING NO:		APPD: Ren An De	DATE: 2021/9/27
		SCALE: N/A	PAGE: 1/2
		UNITS: mm	REV.: C

REV.	REVISION DESCRIPTION	DATE	APPD
△	3.2改2.6	2010.10.26	LIU BING
△	2.6改2.9	2016.6.27	Wuhui

NOTES

Used in DL42002-Y Series Housing.

Accepts AWG #28~14 Wire Range.

Insulation O.D.=0.9~3.1mm.

Material : Phosphor Bronze .

Finish: Tin plated.

Thickness: 0.2 mm.

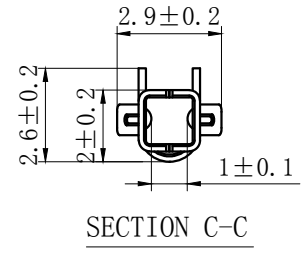
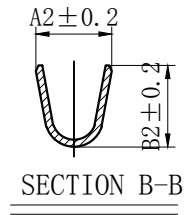
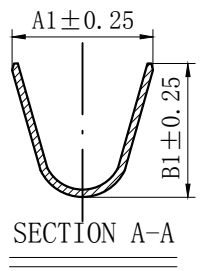
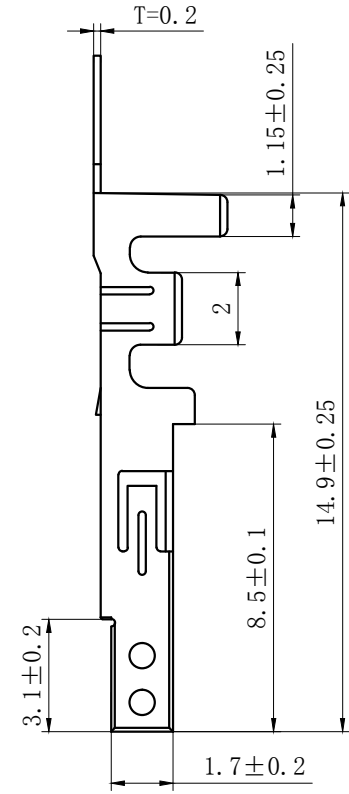
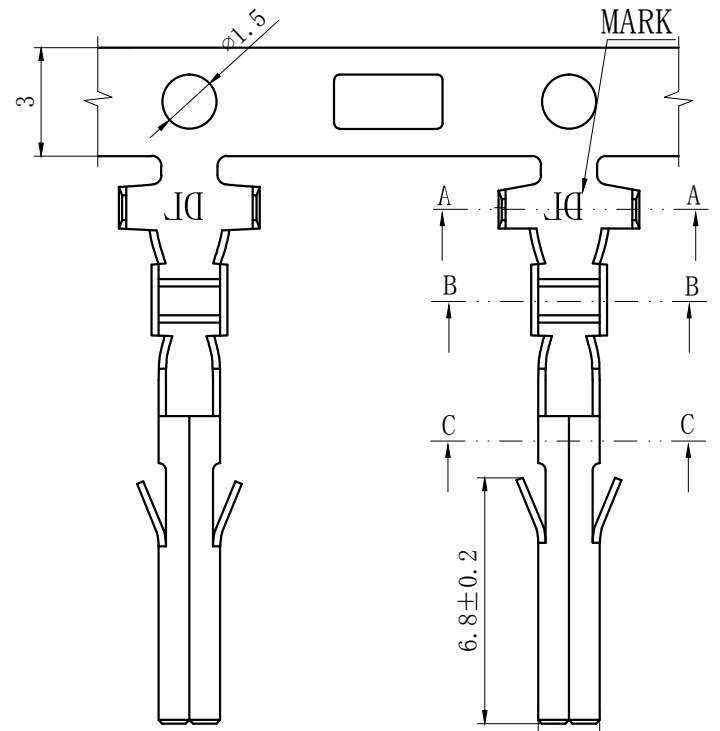

TYPE	Dimension mm				适用线规 AWG#
	A1	B1	A2	B2	
DLL-5556-T-04	4.1	4.4	3.1	3.5	14-18
DLL-5556-T-03	3.9	4.4	2.1	2.7	16-20
DLL-5556-T-02	2.0	2.5	1.5	1.5	24-28

GENERAL TOLERANCES (UNLESS SPECIFIED)		ZHE JIANG DELI CONNECTORS CO., LTD	
.X: ± 0.25	X°: ± 3.0°	PRODUCT NAME:	TITLE: 4.20 mm Pitch Crimp Terminal
.XX: ± 0.15	.X°: ± 2.0°	DL42002 (DLL-5556)-T	
.XXX: ± 0.01	.XX°: ± 1.0°	DR: Chen Quan Long	DATE: 2021/9/27
FINISH:		CHKD: Wu Hui	DATE: 2021/9/27
DRAWING NO:		APPD: Ren An De	DATE: 2021/9/27
		SCALE: N/A	PAGE: 2/2
		UNITS: mm	REV.: A

X-ON Electronics

Largest Supplier of Electrical and Electronic Components

Click to view similar products for [Headers & Wire Housings](#) category:

Click to view products by [DLL](#) manufacturer:

Other Similar products are found below :

[0015917161](#) [0022155065](#) [57102-F02-18ULF](#) [58102-G61-06LF](#) [582553-1](#) [01.001.5753.1](#) [0050291907](#) [02.125.8002.8](#) [609-3404](#) [61062-3](#)
[CSU011177004](#) [622-0430](#) [622-3653LF](#) [63453-116](#) [636-1030](#) [636-1427](#) [636-3427](#) [636-4007](#) [641938-9](#) [65495-038](#) [65692-001LF](#) [65781-018](#)
[65781-047](#) [65817-010LF](#) [65817-015LF](#) [67095-007LF](#) [67601157](#) [68631-112](#) [68645-018](#) [699319-000](#) [70.362.1628.0](#) [70-4210](#) [70-4226B](#) [70-](#)
[4853B](#) [71.350.2428.0](#) [733-134](#) [733-162](#) [760-3052](#) [MHR-64-VUAL](#) [80.063.4001.1](#) [800-90-001-10-001000](#) [801-43-002-10-013000](#)
[801-43-006-10-002000](#) [803-43-024-10-001000](#) [803-93-012-10-001000](#) [8-1437020-4](#) [819-22-004-30-001101](#) [820-22-006-30-001101](#)
[820-22-008-30-001101](#) [821-22-002-10-001101](#)