

技术特性/Specifications:

额定电压 Rated voltage: 250V AC, DC
额定电流 Rated current: 3.5A AC, DC
接触电阻 Contact resistance: 20m Ω max
绝缘电阻 Insulation resistance: 1000M Ω min
耐压 Withstand voltage: 1000V AC/minute
环境温度 Ambient temperature: -40 $^{\circ}$ C~+105 $^{\circ}$ C
适用线规 Wire range: AWG#32~#28

REV.	REVISION DESCRIPTION	DATE	APPD

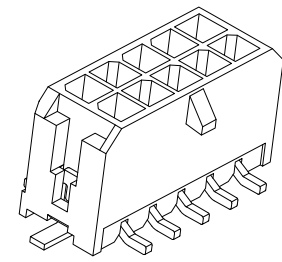
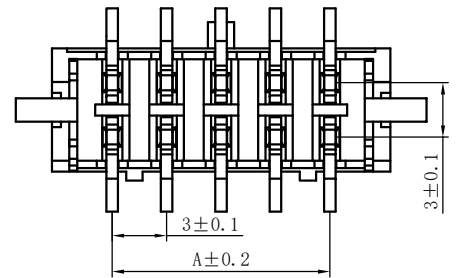

NOTES

Available in 02 through 24 Circuits.
 Mates with DL30001-Y Series Housing.
 Material : LCP UL94V-0.
 Pin Material : Brass.Tin-plated .

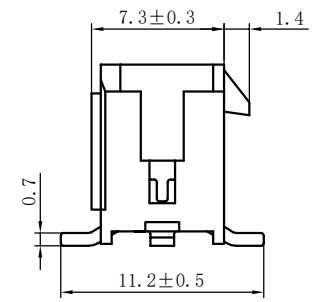
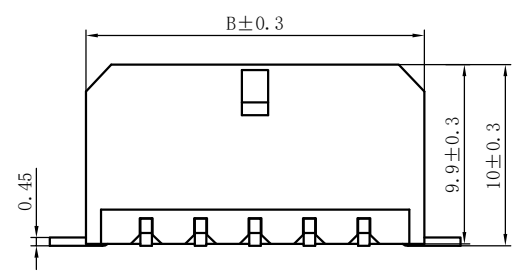

ORDERING INFORMATION

DLXXXXX - XX X - X XX - X X - X - XX
 1 2 3 4 5 6 7 8 9

- PART NO.
- .NO.OF CIRCUIT
- CONN. TYPE
- MATERIAL: 0: PA66 V0 1: PA66 V1 2: PA66 V2
3: PA66 V0 750°C 4: LCP 5: PBT 6:PA9T
- COLOR: NA:NATURE WH:WHITE RE:RED BR:BROWN
GY:GREY BK:BLACK YE:YELLOW
BL:BLUE GR:GREEN PU:PURPLE PI:PINK
OR:ORANGE TR:TRANSPARENT OT:OTHER
- CONTACT MATERIAL: P:PHOSPJOR BRONZE B:BRASS
- FINISH: T:TIN MT:MATT TIN BG/QG:GOLD S:SILVER
- STYLE: Z:WITHOUT K K:WITH K
- SERIAL NUMBER: 00.01.02.....

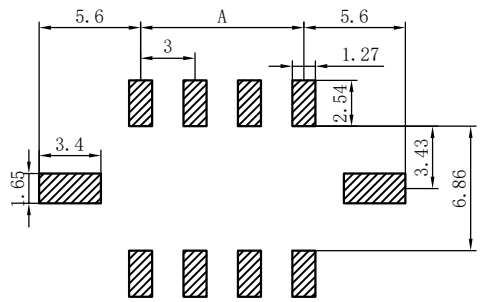
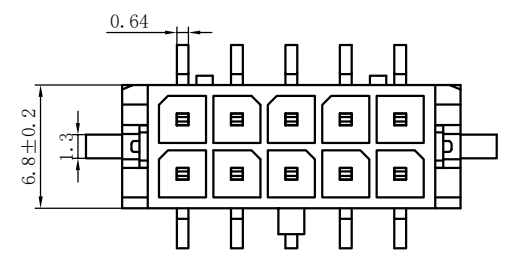

PCB LAYOUT

Circuits	Dimension mm		Circuits	Dimension mm	
	A	B		A	B
2	--	6.60	14	18.00	24.60
4	3.00	9.60	16	21.00	27.60
6	6.00	12.60	18	24.00	30.60
8	9.00	15.60	20	27.00	33.60
10	12.00	18.60	22	30.00	36.60
12	15.00	21.60	24	33.00	39.60

3	③	底座	LCP	1	UL94-V0
2	②	焊片	黄铜	2	镀锡
1	①	接触件	黄铜	N*	镀锡
序号	图号	名称	材料	数量	附件

GENERAL TOLERANCES (UNLESS SPECIFIED)		ZHE JIANG DELI CONNECTORS CO.,LTD			
.X: ± 0.25	.X°: ± 3.0°	PRODUCT NAME: DL30003-AB(43045-AB)		TITLE: 3.0 mm Pitch Wire To Board SMT Wafer	
.XX: ± 0.15	.XX°: ± 2.0°	DR:Chen Quan Long		DATE:20/07/27	
.XXX: ± 0.01	.XXX°: ± 1.0°	DATE:20/07/27		PART NO: DL30003-XXB-XXX-XX-X-XX	
FINISH:		CHKD:Wu Hui	DATE:20/07/27	SCALE: N/A	PAGE: 1/1
DRAWING NO: DL30003-XXB-XXX-XX-X-XX		APPD:Ren An De	DATE:20/07/27	UNITS: mm	REV.: A

REV.	REVISION DESCRIPTION	DATE	APPD

NOTES

Available in 02 through 24 Circuits.
 Mates with DL30001-Y Series Housing.
 Material : LCP UL94V-0.
 Pin Material : Brass.Tin-plated .

ORDERING INFORMATION

DLXXXX - XX X - X XX - X X - X - XX
 1 2 3 4 5 6 7 8 9

- PART NO.
- NO. OF CIRCUIT
- CONN. TYPE
- MATERIAL: 0: PA66 V0 1: PA66 V1 2: PA66 V2
3: PA66 V0 750°C 4: LCP 5: PBT 6:PA9T
- COLOR: NA:NATURE WH:WHITE RE:RED BR:BROWN
GY:GREY BK:BLACK YE:YELLOW
BL:BLUE GR:GREEN PU:PURPLE PI:PINK
OR:ORANGE TR:TRANSPARENT OT:OTHER
- CONTACT MATERIAL: P:PHOSPJOR BRONZE B:BRASS
- FINISH: T:TIN MT:MATT TIN BG/QG:GOLD S:SILVER
- STYLE: Z:WITHOUT K K:WITH K
- SERIAL NUMBER: 00.01.02.....

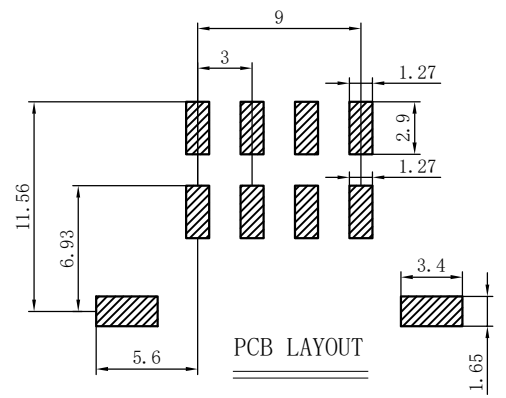
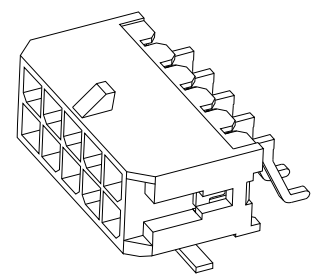
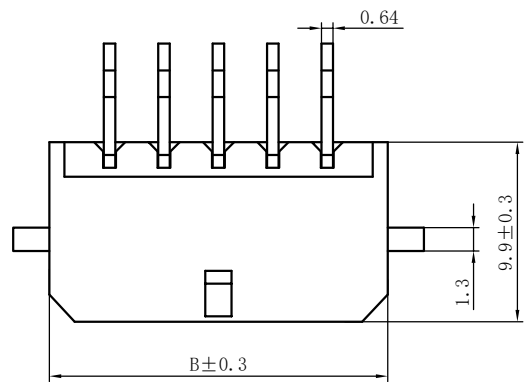
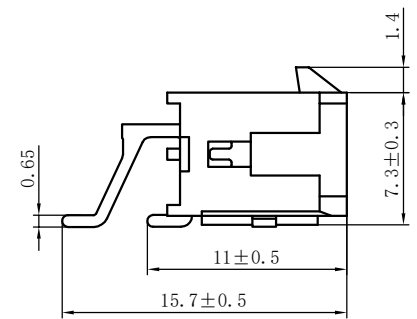
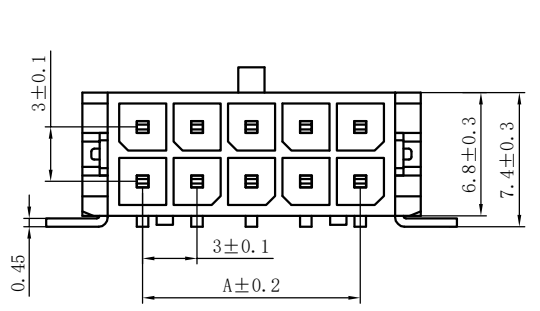

Circuits	Dimension mm		Circuits	Dimension mm	
	A	B		A	B
2	--	6.60	14	18.00	24.60
4	3.00	9.60	16	21.00	27.60
6	6.00	12.60	18	24.00	30.60
8	9.00	15.60	20	27.00	33.60
10	12.00	18.60	22	30.00	36.60
12	15.00	21.60	24	33.00	39.60

3	③	底座	LCP	1	UL94-V0
2	②	焊片	黄铜	2	镀锡
1	①	接触件	黄铜	N*	镀锡
序号	图号	名称	材料	数量	附件

GENERAL TOLERANCES (UNLESS SPECIFIED)		ZHE JIANG DELI CONNECTORS CO.,LTD			
.X: ± 0.25	.X°: ± 3.0°	PRODUCT NAME: DL30003-AWB (43045-AWB)		TITLE: 3.0 mm Pitch Wire To Board SMT Wafer	
.XX: ± 0.15	.X°: ± 2.0°	DR:Chen Quan Long	DATE:20/07/27	PART NO: DL30003-XXWB-XXX-XX-X-XX	
.XXX: ± 0.01	.XX°: ± 1.0°	CHKD:Wu Hui	DATE:20/07/27	SCALE: N/A	PAGE: 1/1
FINISH:		APPD:Ren An De	DATE:20/07/27	UNITS: mm	REV.: A
DRAWING NO: DL30003-XXWB-XXX-XX-X-XX					

REV.	REVISION DESCRIPTION	DATE

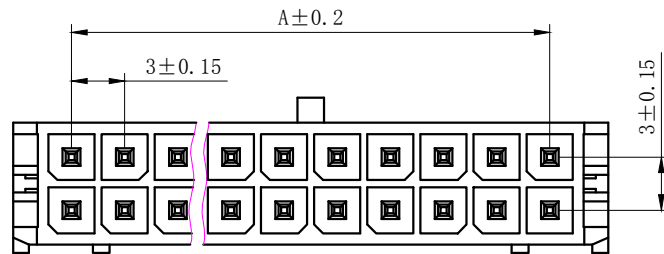
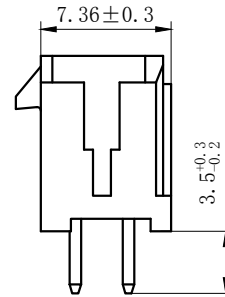
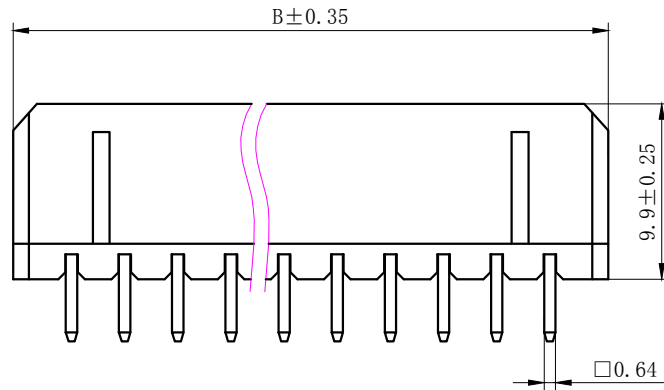

NORES:

1. Rated voltage: 250V AC.DC
2. Rated current: 3.5A AC DC
3. Contact resistance: ≤ 20 m Ω
4. Insulation resistance: ≥ 1000 m Ω
5. Withstand voltage: 1000V AC/minute
6. Ambient temprature: $-40^{\circ}\text{C} \sim 105^{\circ}\text{C}$
7. Materials: Nylon UL94V-0(2)
8. Matched RoHS criteria

ORDERING INFORMATION

DL 30003 - XX A - X XX - X X - X - XX
 1 2 3 4 5 6 7 8 9

1. PART NO.
2. NO. OF CIRCUIT
3. CONN. TYPE
4. MATERIAL: 0:PA66 V0 1:PA66 V1 2:PA66 V2
 3:PA66 V0 750 $^{\circ}\text{C}$ 4:LCP 5:PBT
 6:PA9T 7:9A6T 8:GF PA66
5. COLOR: NA:NATURE RE:RED BR:BROWN
 GY:GREY BK:BLACK YE:YELLOW
 BL:BLUE GR:GREEN PU:PURPLE PI:PINK
 OR:ORANGE TR:TRANSPARENT OT:OTHER
6. CONTACT MATERIAL: P:PHOSPHOR BRONZE B:BRASS
7. FINISH: T:TIN MT:MATT TIN BG/QG:GOLD S:SILVER
8. STYLE: Z:WITHOUT K K:WITH K
9. SERIAL NUMBER: 00.01.02.....

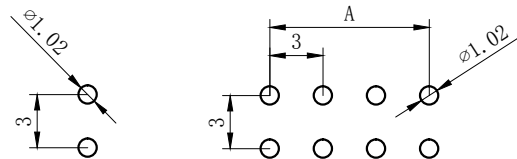

PCB LAYOUT

Circuits	Dimension mm		Circuits	Dimension mm	
	A	B		A	B
2X1	0	6.6	2X7	18.0	24.6
2X2	3.0	9.6	2X8	21.0	27.6
2X3	6.0	12.6	2X9	24.0	30.6
2X4	9.0	15.6	2X10	27.0	33.6
2X5	12.0	18.6	2X11	30.0	36.6
2X6	15.0	21.6	2X12	33.0	39.6

GENERAL TOLERANCES (UNLESS SPECIFIED)		ZHE JIANG DELI CONNECTORS CO.,LTD	
.X: ± 0.25	.X $^{\circ}$: $\pm 3.0^{\circ}$	PRODUCT NAME: DL30003-A(43045-A)	TITLE: 3.0 mm Pitch Wire To Board Wafer
.XX: ± 0.15	.X $^{\circ}$: $\pm 2.0^{\circ}$	DR:Chen Quan Long	DATE:20/04/03
.XXX: ± 0.01	.XX $^{\circ}$: $\pm 1.0^{\circ}$	CHKD: Wu Hui	DATE:20/04/03
FINISH:		APPD:Ren An De	DATE:20/04/03
DRAWING NO: GC-DL30003-XXA-XXX-XX-X-XX		UNITS: mm	REV.: B
		PART NO: DL30003-XXA-XXX-XX-X-XX	SCALE: N/A
		PAGE: 1/1	

REV.	REVISION DESCRIPTION	DATE

NOTES:

1. Rated voltage: 250V AC.DC
2. Rated current: 3.5A AC.DC
3. Contact resistance : $\leq 20m\Omega$
4. Insulation resistance : $\geq 1000M\Omega$
5. Withstand voltage : 1000V AC/minute
6. Ambient temperature : $-40^{\circ}C \sim 105^{\circ}C$
7. Materials : Nylon UL94V-0(2)
8. Green Material RoHS Compliant

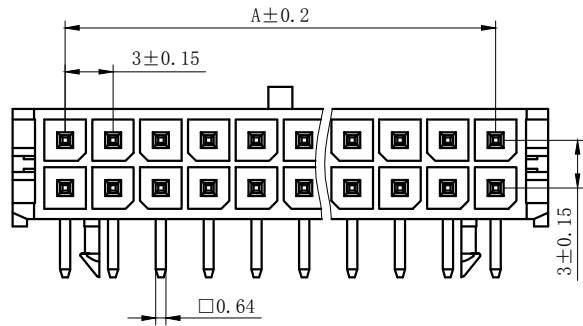
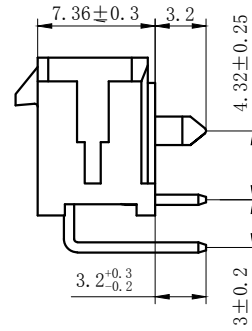
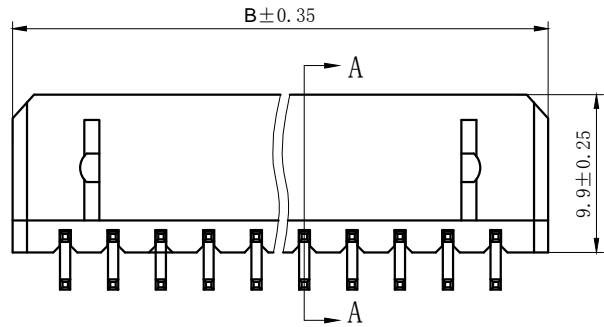

ORDERING INFORMATION

DL 30003 - XX WS - X XX - X X - X - XX
 1 2 3 4 5 6 7 8 9

1. PART NO.
2. . NO. OF CIRCUIT
3. CONN. TYPE
4. MATERIAL: 0: PA66 V0 1: PA66 V1 2: PA66 V2
3: PA66 V0 750°C 4: LCP 5: PBT 6: PA9T
5. COLOR: NA:NATURE RE:RED BR:BROWN
GY:GREY BK:BLACK YE:YELLOW
BL:BLUE GR:GREEN PU:PURPLE PI:PINK
OR:ORANGE TR:TRANSPARENT OT:OTHER
6. CONTACT MATERIAL: P:PHOSPHOR BRONZE B:BRASS
7. FINISH: T:TIN MT:MATT TIN BG/QG:GOLD S:SILVER
8. STYLE: Z:WITHOUT K K:WITH K
9. SERIAL NUMBER: 00.01.02.....

Circuits	Dimension mm		
	A	B	C
2X1	0	6.6	0
2X2	3.0	9.6	0
2X3	6.0	12.6	0
2X4	9.0	15.6	4.7
2X5	12.0	18.6	7.7
2X6	15.0	21.6	10.7
2X7	18.0	24.6	13.7
2X8	21.0	27.6	16.7
2X9	24.0	30.6	19.7
2X10	27.0	33.6	22.7
2X11	30.0	36.6	25.7
2X12	33.0	39.6	28.7

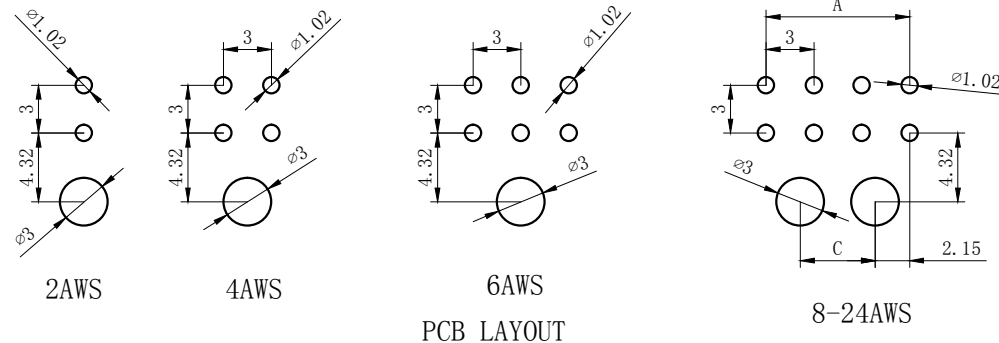

GENERAL TOLERANCES (UNLESS SPECIFIED)		ZHE JIANG DELI CONNECTORS CO., LTD	
.X: ± 0.25	X°: ± 3.0°	PRODUCT NAME: DL30003-AWS(43045-AWS)	TITLE: 3.0 mm Pitch Wire To Board Wafer
.XX: ± 0.15	.X°: ± 2.0°	DR:Chen Quan Long	DATE:20/04/03
.XXX: ± 0.01	.XX°: ± 1.0°	CHKD: Wu Hui	DATE:20/04/03
FINISH:		APPD:Ren An De	DATE:20/04/03
DRAWING NO: GC-DL30003-XXWS-XXX-XX-X-XX		PART NO: DL30003-XXWS-XXX-XX-X-XX	
		SCALE: N/A	PAGE: 1/1
		UNITS: mm	REV.: B

REV.	REVISION DESCRIPTION	DATE	APPD

NOTES

Available in 02 through 24 Circuits.
 Mates with DL30001/DL30003 series housing.
 Material : Nylon UL94V-0(2).
 Accepts DL30001-T Crimp Terminal.

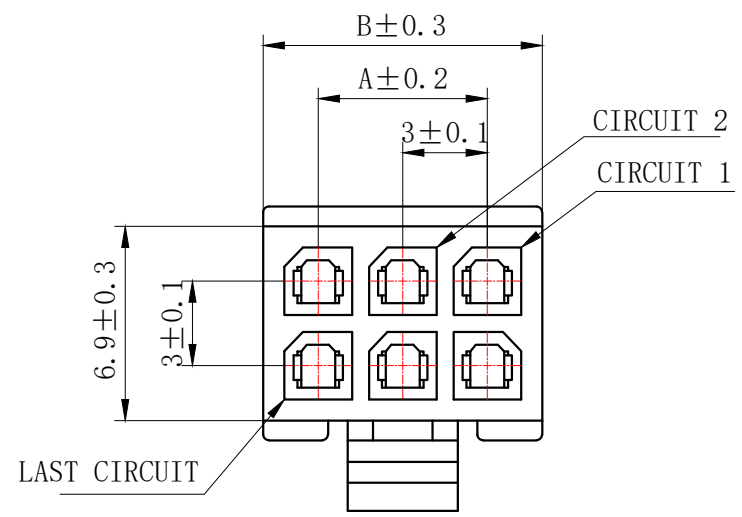
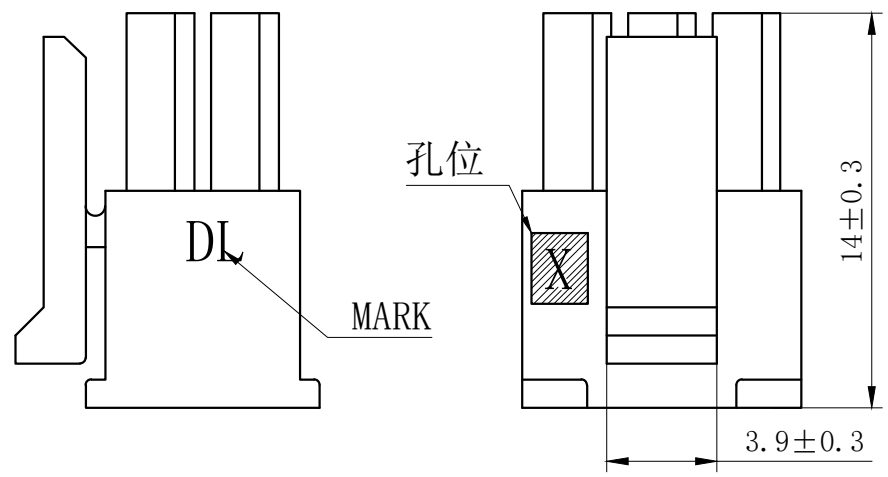

ORDERING INFORMATION

DL XXXX - XX X - X XX - XX
 1 2 3 4 5 6

- PART NO.
- . NO. OF CIRCUIT
- CONN. TYPE
- MATERIAL: 0:PA66 V0 1:PA66 V1 2:PA66 V2
 3:PA66 V0 750°C 4:LCP 5:PBT
 6:PA9T 7:9A6T 8:GF PA66
- COLOR: NA:NATURE WH:WHITE RE:RED BR:BROWN
 GY:GREY BK:BLACK YE:YELLOW
 BL:BLUE GR:GREEN PU:PURPLE PI:PINK
 OR:ORANGE TR:TRANSPARENT OT:OTHER
- SERIAL NUMBER: 00.01.02.....

Circuits	TYPE	Dimension mm	
		A	B
2X1	43025-2Y	-	3.90
2X2	43025-4Y	3.00	6.90
2X3	43025-6Y	6.00	9.90
2X4	43025-8Y	9.00	12.90
2X5	43025-10Y	12.00	15.90
2X6	43025-12Y	15.00	18.90
2X7	43025-14Y	18.00	21.90
2X8	43025-16Y	21.00	24.90
2X9	43025-18Y	24.00	27.90
2X10	43025-20Y	27.00	30.90
2X11	43025-22Y	30.00	33.90
2X12	43025-24Y	33.00	36.90

GENERAL TOLERANCES (UNLESS SPECIFIED)		ZHE JIANG DELI CONNECTORS CO., LTD	
.X: ± 0.25	X°: ± 3.0°	PRODUCT NAME: DL30001-Y(43025-Y)	TITLE: 3.0mm Pitch Housing
.XX: ± 0.15	.X°: ± 2.0°	DR:Chen Quan Long	DATE:20/08/01
.XXX: ± 0.01	.XX°: ± 1.0°	CHKD: Wu Hui	DATE:20/08/01
FINISH: _____		APPD:Ren An De	DATE:20/08/01
DRAWING NO: GC-DL30001-XXY-XXX-XX			

REV.	REVISION DESCRIPTION	DATE	APPD

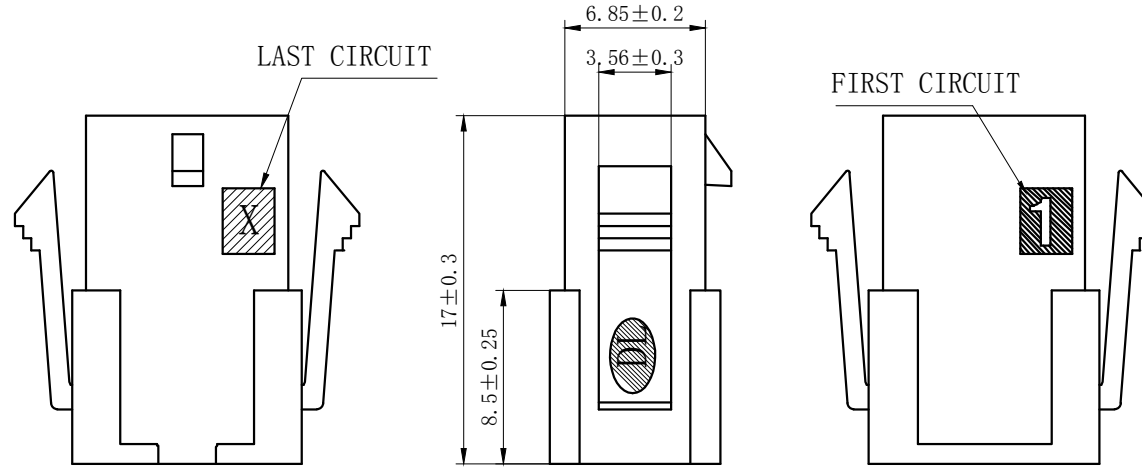

NOTES

Available in 02 through 24 Circuits.
 Mates with DL30001-Y Series Housing.
 Material : Nylon UL94V-0 (2) .
 Accepts DL30001-RT Crimp Terminal.

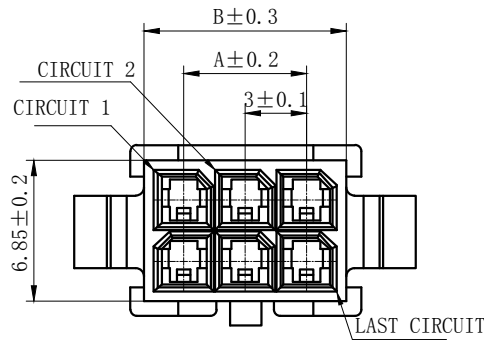

ORDERING INFORMATION

DL XXXXX - XX X - X XX - XX
 1 2 3 4 5 6

- PART NO.
- NO. OF CIRCUIT
- CONN. TYPE
- MATERIAL: 0:PA66 V0 1:PA66 V1 2:PA66 V2
 3:PA66 V0 750°C 4:LCP 5:PBT
 6:PA9T 7:PA6T 8:GF PA66
- COLOR: NA:NATURE WH:WHITE RE:RED BR:BROWN
 GY:GREY BK:BLACK YE:YELLOW
 BL:BLUE GR:GREEN PU:PURPLE PI:PINK
 OR:ORANGE TR:TRANSPARENT OT:OTHER
- SERIAL NUMBER: 00.01.02.....

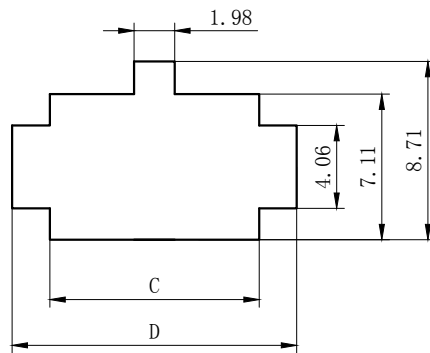

安装尺寸

Circuits	TYPE	Dimension mm			
		A	B	C	D
2X1	43020-2R	-	3.90	4.21	7.90
2X2	43020-4R	3.00	6.90	7.21	10.90
2X3	43020-6R	6.00	9.90	10.21	13.90
2X4	43020-8R	9.00	12.90	13.21	16.90
2X5	43020-10R	12.00	15.90	16.21	19.90
2X6	43020-12R	15.00	18.90	19.21	22.90
2X7	43020-14R	18.00	21.90	22.21	25.90
2X8	43020-16R	21.00	24.90	25.21	28.90
2X9	43020-18R	24.00	27.90	28.21	31.90
2X10	43020-20R	27.00	30.90	31.21	34.90
2X11	43020-22R	30.00	33.90	34.21	37.90
2X12	43020-24R	33.00	36.90	37.21	40.90

GENERAL TOLERANCES (UNLESS SPECIFIED)		ZHE JIANG DELI CONNECTORS CO., LTD	
.X: ± 0.25	X°: ± 3.0°	PRODUCT NAME: DL30001-R (43020-R)	TITLE: 3.0mm Pitch Wire To Wire Plug Housing
.XX: ± 0.15	.X°: ± 2.0°	DR:Chen Quan Long	DATE:20/08/01
.XXX: ± 0.01	.XX°: ± 1.0°	DATE:20/08/01	PART NO: DL30001-XXR-XXX-XX
FINISH:		CHKD: Wu Hui	DATE:20/08/01
DRAWING NO: QC-DL30001-XXR-XXX-XX		APPD:Ren An De	DATE:20/08/01
		SCALE: N/A	PAGE: 1/2
		UNITS: mm	REV.: A

REV.	REVISION DESCRIPTION	DATE	APPD

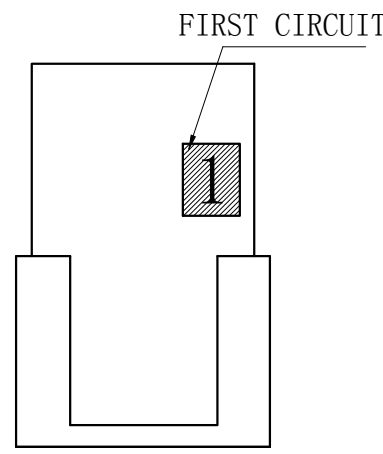
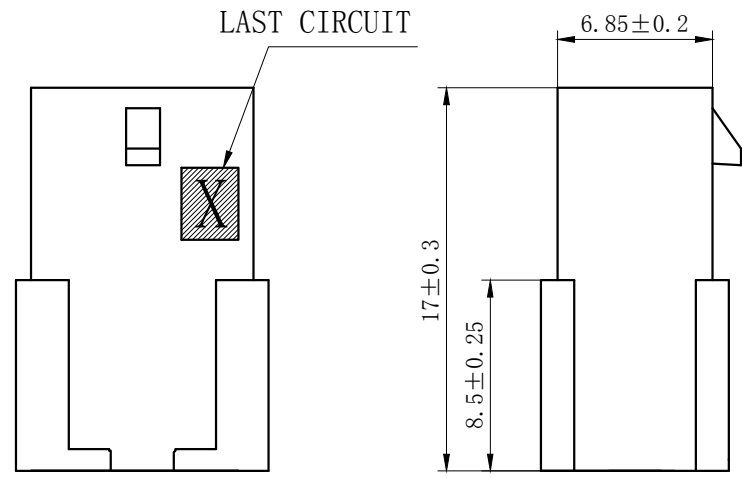

NOTES

Available in 02 through 24 Circuits.
 Mates with DL30001-Y Series Housing.
 Material : Nylon UL94V-0 (2) .
 Accepts DL30001-RT Crimp Terminal.

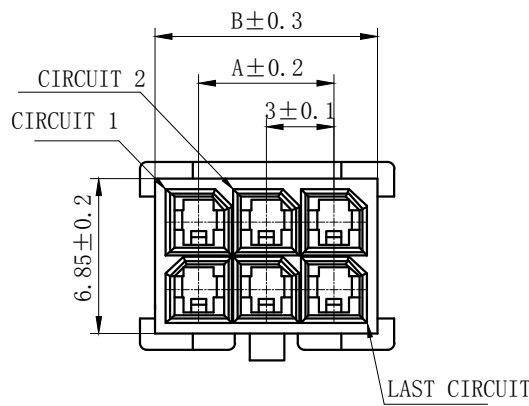

ORDERING INFORMATION

DL 30001 - XX RF - X XX - XX
 1 2 3 4 5 6

- PART NO.
- .NO. OF CIRCUIT
- CONN. TYPE
- MATERIAL: 0:PA66 V0 1:PA66 V1 2:PA66 V2
 3:PA66 V0 750°C 4:LCP 5:PBT
 6:PA9T 7:9A6T 8:GF PA66
- COLOR: NA:NATURE WH:WHITE RE:RED BR:BROWN
 GY:GREY BK:BLACK YE:YELLOW
 BL:BLUE GR:GREEN PU:PURPLE PI:PINK
 OR:ORANGE TR:TRANSPARENT OT:OTHER
- SERIAL NUMBER: 00.01.02.....

Circuits	TYPE	Dimension mm	
		A	B
2X1	43020-2RF	-	3.90
2X2	43020-4RF	3.00	6.90
2X3	43020-6RF	6.00	9.90
2X4	43020-8RF	9.00	12.90
2X5	43020-10RF	12.00	15.90
2X6	43020-12RF	15.00	18.90
2X7	43020-14RF	18.00	21.90
2X8	43020-16RF	21.00	24.90
2X9	43020-18RF	24.00	27.90
2X10	43020-20RF	27.00	30.90
2X11	43020-22R	30.00	33.90
2X12	43020-24R	33.00	36.90

GENERAL TOLERANCES (UNLESS SPECIFIED)		ZHE JIANG DELI CONNECTORS CO ., LTD	
.X: ± 0.25	X° : ± 3.0°	PRODUCT NAME: DL30001-R (43020-RF)	TITLE: 3.0mm Pitch Wire To Wire Plug Housing
.XX: ± 0.15	.X° : ± 2.0°	DR:Yuan Jun Rong	DATE:20/08/01
.XXX: ± 0.01	.XX° : ± 1.0°	CHKD: Wu Hui	DATE:20/08/01
DRAWING NO: QC-DL30001-XXRF-XXX-XX		APPD:Ren An De	DATE:20/08/01
		SCALE: N/A	PAGE: 1/2
		UNITS: mm	REV.: A

REV.	REVISION DESCRIPTION	DATE	APPD

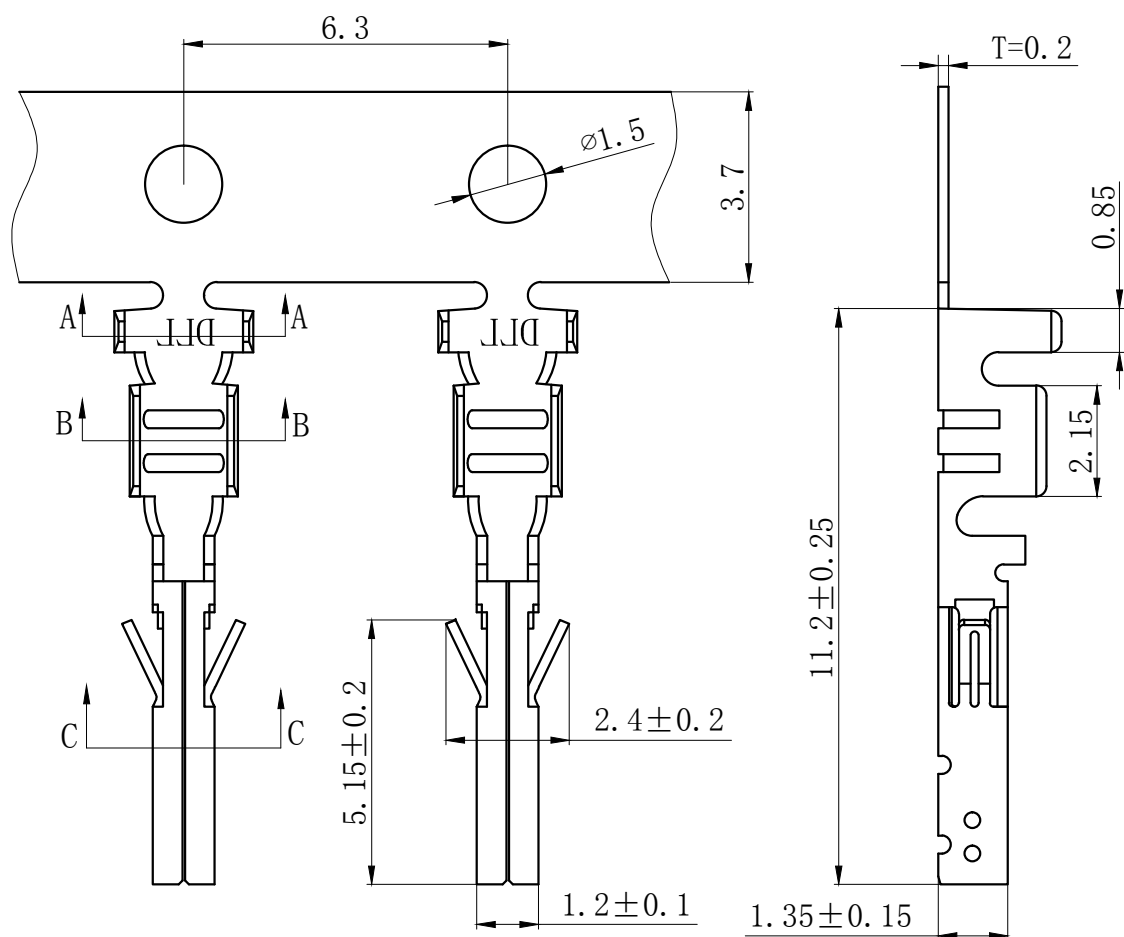

NOTES

Used in DL30001-Y Series Housing.
 Accepts AWG #28~20 Wire Range.
 Material : Phosphor Bronze .
 Finish: Tin plated.
 Qty/Reel: 10000 PCS.
 Thickness: 0.2 mm.
 Green Material RoHS Compliant.

ORDERING INFORMATION

DL XXXXX - XX - X - X - X - XX
 1 2 3 4 5 6

- PART NO.
- TERMINAL CODE
- MATERIAL TYPE: 1: PHOSPHOR BRONZE 2: BRASS 3: IRON
4: STAINLESS STEEL 5: OTHER
- TECHNICS: 0: UNPLATED 1: FIRST PLATING 2: POST PLATING
3: OTHER
- FINISH: 1: TIN-PLATED 2: MATTE PLATED 3: NICKEL PLATED
4: PICKLING 5: SILVER PLATED 6: GOLD PLATED
7: GALVANIZED 8: OTHER
- SERIAL NUMBER: 00.01.02.....

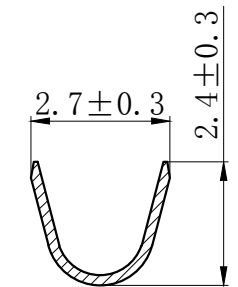

SECTION A-A

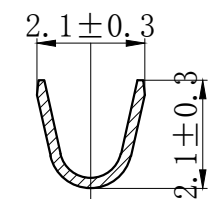

SECTION B-B

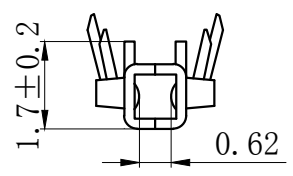

SECTION C-C

GENERAL TOLERANCES (UNLESS SPECIFIED)		ZHE JIANG DELI CONNECTORS CO., LTD	
.X: ± 0.25	.X°: ± 3.0°	PRODUCT NAME: DL30001-T(43030-T)	TITLE: 3.0mm Pitch Wire To Board Crimp Terminal
.XX: ± 0.15	.X°: ± 2.0°	DR: Chen Quan Long	DATE: 20.03.11
.XXX: ± 0.01	.XX°: ± 1.0°	CHKD: Wu Hui	DATE: 20.03.11
FINISH:		APPD: Ren An De	DATE: 20.03.11
DRAWING NO: GC-DL30001-T-X-X-X-XX		SCALE: N/A	PAGE: 1/1
		UNITS: mm	REV.: A

REV.	REVISION DESCRIPTION	DATE	APPD

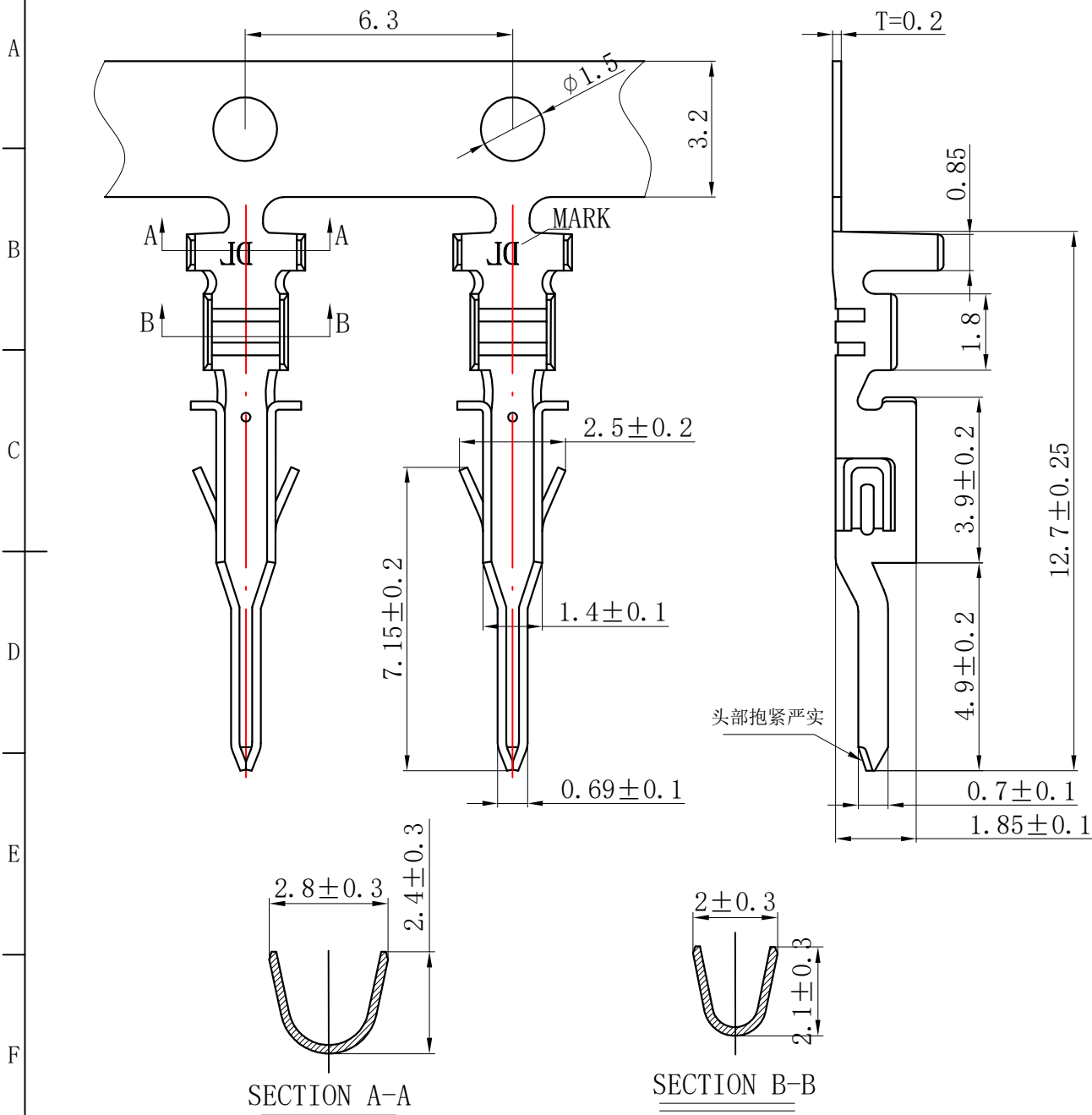

NOTES

Used in DL30001-R Series Housing.
 Accepts AWG #28~20 Wire Range.
 Material : Phosphor Bronze .
 Finish: Tin plated.
 Qty/Reel: 10000 PCS.
 Thickness: 0.2 mm.
 Green Material RoHS Compliant.

ORDERING INFORMATION

DL XXXXX - XX - X - X - X - XX
 1 2 3 4 5 6

- PART NO.
- TERMINAL CODE
- MATERIAL TYPE: 1: PHOSPJOR BRONZE 2: BRASS 3: IRON
4: STAINLESS STEEL 5: OTHER
- TECHNICS: 0: UNPLATED 1: FIRST PLATING 2: POST PLATING
3: OTHER
- FINISH: 1: TIN-PLATED 2: MATTE PLATED 3: NICKEL PLATED
4: PICKLING 5: SILVER PLATED 6: GOLD PLATED
7: GALVANIZED 8: OTHER
- SERIAL NUMBER: 00.01.02....

GENERAL TOLERANCES (UNLESS SPECIFIED)		ZHE JIANG DELI CONNECTORS CO., LTD	
.X: ± 0.25	X°: ± 3.0°	PRODUCT NAME: DL30001-RT (43031-RT)	TITLE: 3.0mm Pitch Wire To Wire Crimp Terminal
.XX: ± 0.15	.X°: ± 2.0°	DR: Chen Quan Long	DATE: 20.03.11
.XXX: ± 0.01	.XX°: ± 1.0°	CHKD: Wu Hui	DATE: 20.03.11
FINISH:		APPD: Ren An De	DATE: 20.03.11
DRAWING NO: GC-DL30001-RT-X-X-X-XX		SCALE: N/A	PAGE: 1/1
		UNITS: mm	REV.: A

X-ON Electronics

Largest Supplier of Electrical and Electronic Components

Click to view similar products for [Headers & Wire Housings](#) category:

Click to view products by [DLL](#) manufacturer:

Other Similar products are found below :

[0015917161](#) [0022155065](#) [57102-F02-18ULF](#) [58102-G61-06LF](#) [582553-1](#) [01.001.5753.1](#) [0050291907](#) [02.125.8002.8](#) [609-3404](#) [61062-3](#)
[CSU011177004](#) [622-0430](#) [622-3653LF](#) [63453-116](#) [636-1030](#) [636-1427](#) [636-3427](#) [636-4007](#) [641938-9](#) [65495-038](#) [65692-001LF](#) [65781-018](#)
[65781-047](#) [65817-010LF](#) [65817-015LF](#) [67095-007LF](#) [67601157](#) [68631-112](#) [68645-018](#) [699319-000](#) [70.362.1628.0](#) [70-4210](#) [70-4226B](#) [70-](#)
[4853B](#) [71.350.2428.0](#) [733-134](#) [733-162](#) [MHR-64-VUAL](#) [80.063.4001.1](#) [800-90-001-10-001000](#) [801-43-002-10-013000](#) [801-43-006-10-](#)
[002000](#) [803-43-024-10-001000](#) [803-93-012-10-001000](#) [8-1437020-4](#) [819-22-004-30-001101](#) [820-22-006-30-001101](#) [820-22-008-30-001101](#)
[821-22-002-10-001101](#) [821-22-003-10-002101](#)