



## 技术特性/Specifications:

额定电压 Rated voltage: 250V AC, DC  
额定电流 Rated current: 3.5A AC, DC  
接触电阻 Contact resistance: 20m $\Omega$  max  
绝缘电阻 Insulation resistance: 1000M $\Omega$  min  
耐压 Withstand voltage: 1000V AC/minute  
环境温度 Ambient temperature: -40 $^{\circ}$ C~+105 $^{\circ}$ C  
适用线规 Wire range: AWG#32~#28

REV.	REVISION DESCRIPTION	DATE	APPD



### NOTES

Available in 02 through 24 Circuits.  
 Mates with DL30001-Y Series Housing.  
 Material : LCP UL94V-0.  
 Pin Material : Brass.Tin-plated .



PCB LAYOUT



3	③	基座	LCP	1	UL94V-0
2	②	焊片	黄铜	2	镀锡
1	①	接触件	黄铜	N*	镀锡
序号	图号	名称	材料	数量	附件

Circuits	Product name	Dimension mm		Circuits	Product name	Dimension mm	
		A	B			A	B
2x1	43045-2AB	---	6.60	2x7	43045-14AB	18.00	24.60
2x2	43045-4AB	3.00	9.60	2x8	43045-16AB	21.00	27.60
2x3	43045-6AB	6.00	12.60	2x9	43045-18AB	24.00	30.60
2x4	43045-8AB	9.00	15.60	2x10	43045-20AB	27.00	33.60
2x5	43045-10AB	12.00	18.60	2x11	43045-22AB	30.00	36.60
2x6	43045-12AB	15.00	21.60	2x12	43045-24AB	33.00	39.60

GENERAL TOLERANCES (UNLESS SPECIFIED)		ZHE JIANG DELI CONNECTORS CO.,LTD			
.X: ± 0.25	X° : ± 3.0°	PRODUCT NAME: DL30003(43045)-AB		TITLE: 3.0 mm Pitch Wire To Board SMT Wafer	
.XX: ± 0.15	.X° : ± 2.0°	DR:Chen Quan Long	DATE:20/07/27	PART NO:	
.XXX: ± 0.01	.XX° : ± 1.0°	CHKD:Wu Hui	DATE:20/07/27	SCALE: N/A	PAGE: 1/1
DRAWING NO:		APPD:Ren An De	DATE:20/07/27	UNITS: mm	REV.: A

REV.	REVISION DESCRIPTION	DATE	APPD

### NOTES

Available in 02 through 24 Circuits.  
 Mates with DL30001-Y Series Housing.  
 Material : LCP UL94V-0.  
 Pin Material : Brass.Tin-plated .

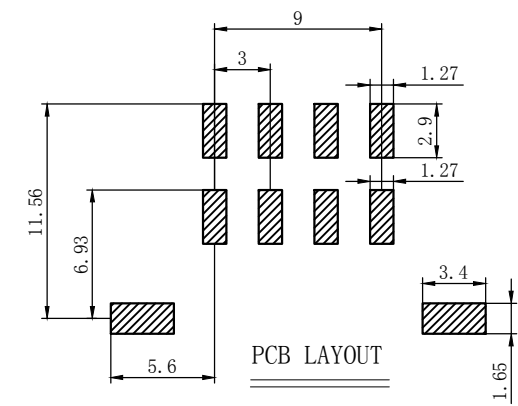
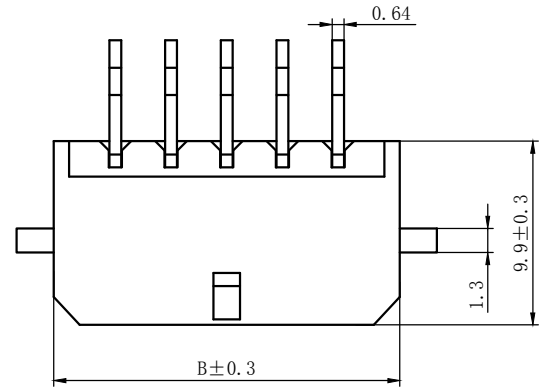

Circuits	Product name	Dimension mm		Circuits	Product name	Dimension mm	
		A	B			A	B
2x1	43045-2AWB	--	6.60	2x7	43045-14AWB	18.00	24.60
2x2	43045-4AWB	3.00	9.60	2x8	43045-16AWB	21.00	27.60
2x3	43045-6AWB	6.00	12.60	2x9	43045-18AWB	24.00	30.60
2x4	43045-8AWB	9.00	15.60	2x10	43045-20AWB	27.00	33.60
2x5	43045-10AWB	12.00	18.60	2x11	43045-22AWB	30.00	36.60
2x6	43045-12AWB	15.00	21.60	2x12	43045-24AWB	33.00	39.60

3	③	基座	LCP	1	UL94V-0
2	②	焊片	黄铜	2	镀锡
1	①	接触件	黄铜	N*	镀锡
序号	图号	名称	材料	数量	附件

GENERAL TOLERANCES (UNLESS SPECIFIED)		ZHE JIANG DELI CONNECTORS CO., LTD			
.X: ± 0.25	X°: ± 3.0°	PRODUCT NAME: DL30003(43045)-AWB		TITLE: 3.0 mm Pitch Wire To Board SMT Wafer	
.XX: ± 0.15	.X°: ± 2.0°	DR:Chen Quan Long	DATE:20/07/27	PART NO:	
.XXX: ± 0.01	.XX°: ± 1.0°	CHKD:Wu Hui	DATE:20/07/27	SCALE: N/A	PAGE: 1/1
DRAWING NO:		APPD:Ren An De	DATE:20/07/27	UNITS: mm	REV.: A

REV.	REVISION DESCRIPTION	DATE

**NORES:**

1. Rated voltage: 250V AC.DC
2. Rated current: 3.5A AC DC
3. Contact resistance:  $\leq 20 \text{ m}\Omega$
4. Insulation resistance:  $\geq 1000 \text{ m}\Omega$
5. Withstand voltage: 1000V AC/minute
6. Ambient temprature:  $-40^{\circ}\text{C} \sim 105^{\circ}\text{C}$
7. Materials: Nylon UL94V-0(2)
8. Matched RoHS criteria

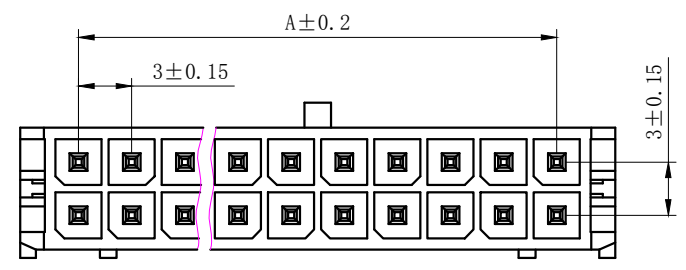
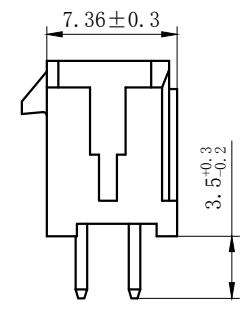
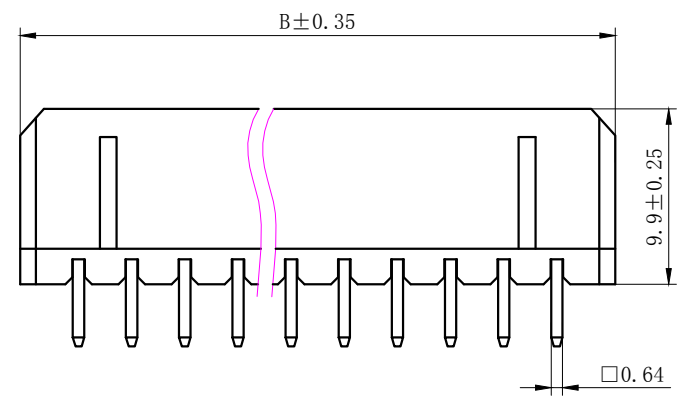

Circuits	TYPE	Dimension mm	
		A	B
2X1	43045-2A	-	6.6
2X2	43045-4A	3.0	9.6
2X3	43045-6A	6.0	12.6
2X4	43045-8A	9.0	15.6
2X5	43045-10A	12.0	18.6
2X6	43045-12A	15.0	21.6
2X7	43045-14A	18.0	24.6
2X8	43045-16A	21.0	27.6
2X9	43045-18A	24.0	30.6
2X10	43045-20A	27.0	33.6
2X11	43045-22A	30.0	36.6
2X12	43045-24A	33.0	39.6



2A

4-24A

PCB LAYOUT

GENERAL TOLERANCES (UNLESS SPECIFIED)		ZHE JIANG DELI CONNECTORS CO., LTD	
.X: ± 0.25	X°: ± 3.0°	PRODUCT NAME: <b>DL30003(43045)-A</b>	TITLE: 3.0 mm Pitch Wire To Board Wafer
.XX: ± 0.15	.X°: ± 2.0°	DR: Chen Quan Long	DATE: 20/04/03
.XXX: ± 0.01	.XX°: ± 1.0°	CHKD: Wu Hui	DATE: 20/04/03
DRAWING NO:		APPD: Ren An De	DATE: 20/04/03
FINISH:		SCALE: N/A	PAGE: 1/1
PART NO:		UNITS: mm	REV.: B

REV.	REVISION DESCRIPTION	DATE

**NOTES:**

- 1、Rated voltage: 250V AC.DC
- 2、Rated current: 3.5A AC.DC
- 3、Contact resistance :  $\leq 20m\Omega$
- 4、Insulation resistance :  $\geq 1000M\Omega$
- 5、Withstand voltage : 1000V AC/minute
- 6、Ambient temperature :  $-40^{\circ}C \sim 105^{\circ}C$
- 7、Materials : Nylon UL94V-0(2)
- 8、Green Material RoHS Compliant

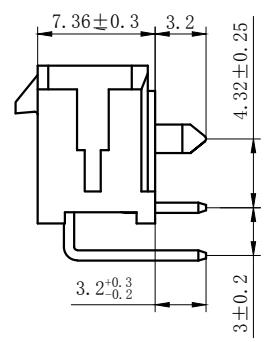
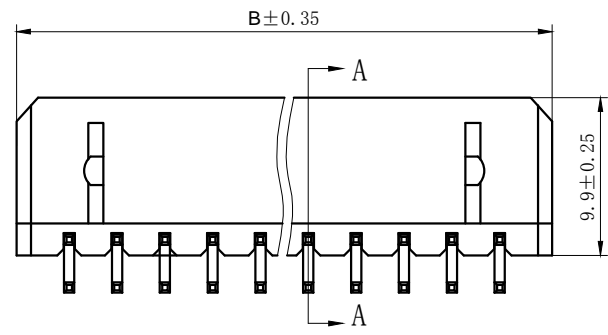

2AWS



4AWS



6AWS

PCB LAYOUT

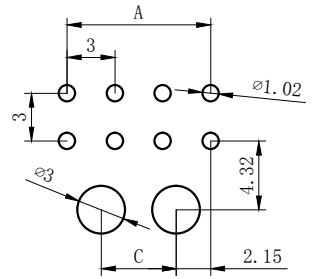

8-24AWS

Circuits	Product name	Dimension mm		
		A	B	C
2X1	43045-2AWS	-	6.6	-
2X2	43045-4AWS	3.0	9.6	-
2X3	43045-6AWS	6.0	12.6	-
2X4	43045-8AWS	9.0	15.6	4.7
2X5	43045-10AWS	12.0	18.6	7.7
2X6	43045-12AWS	15.0	21.6	10.7
2X7	43045-14AWS	18.0	24.6	13.7
2X8	43045-16AWS	21.0	27.6	16.7
2X9	43045-18AWS	24.0	30.6	19.7
2X10	43045-20AWS	27.0	33.6	22.7
2X11	43045-22AWS	30.0	36.6	25.7
2X12	43045-24AWS	33.0	39.6	28.7

GENERAL TOLERANCES (UNLESS SPECIFIED)		ZHE JIANG DELI CONNECTORS CO., LTD	
.X: ± 0.25	X°: ± 3.0°	PRODUCT NAME: DL30003 (43045)-AWS	TITLE: 3.0 mm Pitch Wire To Board Wafer
.XX: ± 0.15	.X°: ± 2.0°	DR: Chen Quan Long	DATE: 20/04/03
.XXX: ± 0.01	.XX°: ± 1.0°	CHKD: Wu Hui	DATE: 20/04/03
FINISH:		APPD: Ren An De	DATE: 20/04/03
DRAWING NO:			
			PART NO:
			SCALE: N/A
			PAGE: 1/1
			UNITS: mm
			REV.: B

REV.	REVISION DESCRIPTION	DATE

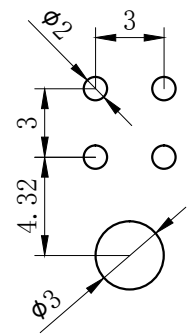
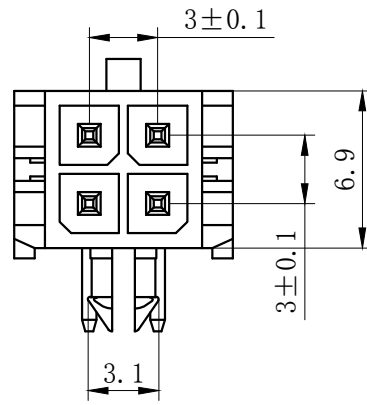
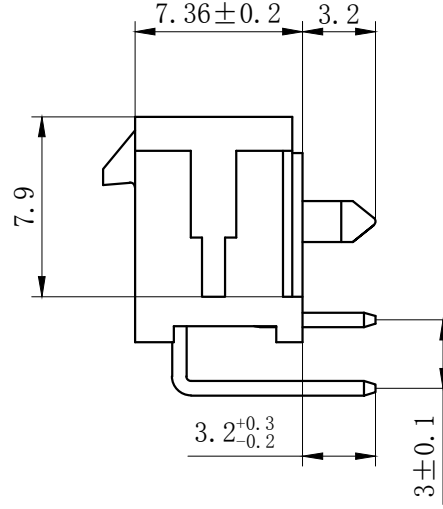
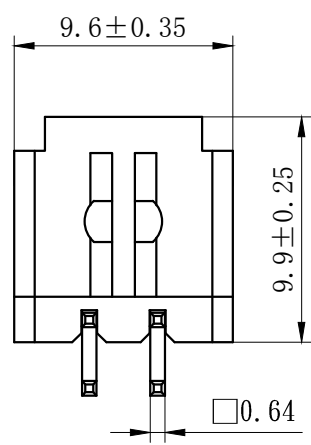

4AWS

PCB 安装尺寸

NOTES:

- 1、Rated voltage: 250V AC.DC
- 2、Rated current: 3.5A AC.DC
- 3、Contact resistance :  $\leq 20m\Omega$
- 4、Insulation resistance :  $\geq 1000M\Omega$
- 5、Withstand voltage : 1000V AC/minute
- 6、Ambient temperature :  $-40^{\circ}C \sim 105^{\circ}C$
- 7、Materials : Nylon UL94V-0(2)
- 8、Green Material RoHS Compliant

GENERAL TOLERANCES (UNLESS SPECIFIED)		ZHE JIANG DELI CONNECTORS CO.,LTD	
.X: $\pm 0.25$	X° : $\pm 3.0^{\circ}$	PRODUCT NAME: DL30003(43045)-4AWS-02	TITLE: 3.0 mm Pitch Wire To Board Wafer
.XX: $\pm 0.15$	.X° : $\pm 2.0^{\circ}$	DR:Chen Quan Long	DATE:20/04/03
.XXX: $\pm 0.01$	.XX° : $\pm 1.0^{\circ}$	CHKD: Wu Hui	DATE:20/04/03
FINISH: 		APPD:Ren An De	DATE:20/04/03
DRAWING NO:		SCALE: N/A	PAGE: 1/1
		UNITS: mm	REV.: B

REV.	REVISION DESCRIPTION	DATE	APPD

### NOTES

Available in 02 through 24 Circuits.  
 Mates with DL30001/DL30003 series housing.  
 Material : Nylon UL94V-0(2).  
 Accepts DL30001-T Crimp Terminal.



Circuits	PRODUCT NAME	Dimension mm		Circuits	PRODUCT NAME	Dimension mm	
		A	B			A	B
2X1	43025-2Y	-	3.90	2X7	43025-14Y	18.00	21.90
2X2	43025-4Y	3.00	6.90	2X8	43025-16Y	21.00	24.90
2X3	43025-6Y	6.00	9.90	2X9	43025-18Y	24.00	27.90
2X4	43025-8Y	9.00	12.90	2X10	43025-20Y	27.00	30.90
2X5	43025-10Y	12.00	15.90	2X11	43025-22Y	30.00	33.90
2X6	43025-12Y	15.00	18.90	2X12	43025-24Y	33.00	36.90

GENERAL TOLERANCES (UNLESS SPECIFIED)		ZHE JIANG DELI CONNECTORS CO., LTD			
.X: ± 0.25	X°: ± 3.0°	PRODUCT NAME: DL30001(43025)-Y		TITLE: 3.0mm Pitch Housing	
.XX: ± 0.15	.X°: ± 2.0°	DR:Chen Quan Long		DATE:20/08/01	
.XXX: ± 0.01	.XX°: ± 1.0°	CHKD: Wu Hui		DATE:20/08/01	
DRAWING NO:		APPD:Ren An De		DATE:20/08/01	
FINISH:			SCALE: N/A		
			UNITS: mm		PAGE: 1/1
			REV.: A		

REV.	7	REVISION DESCRIPTION	8	DATE	APPD

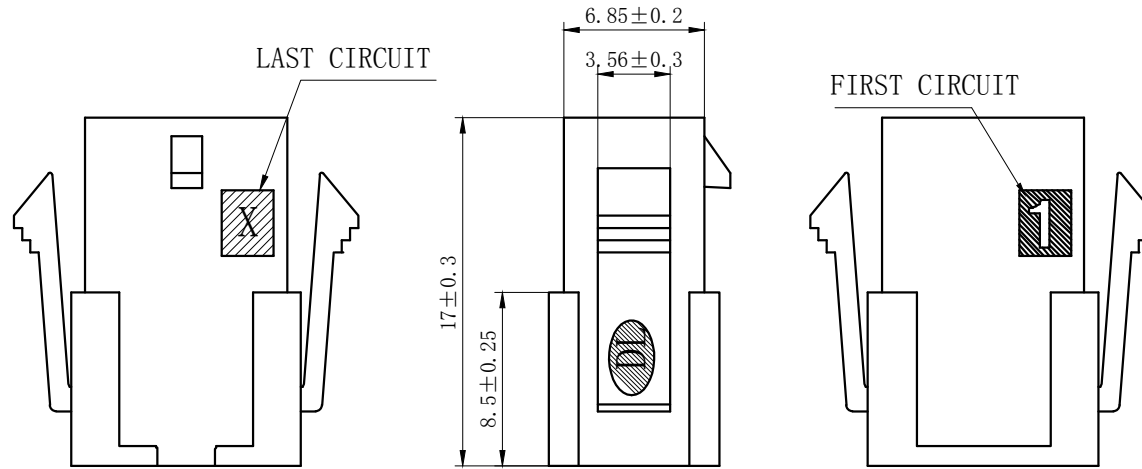

### NOTES

Available in 02 through 24 Circuits.  
Mates with DL30001-Y Series Housing.  
Material : Nylon UL94V-0 (2) .  
Accepts DL30001-RT Crimp Terminal.

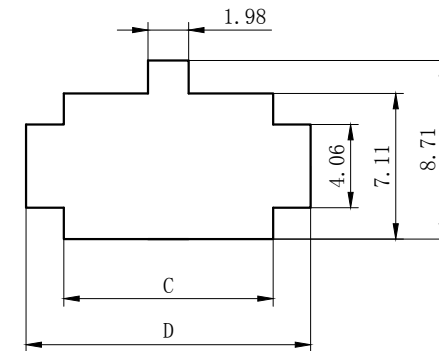
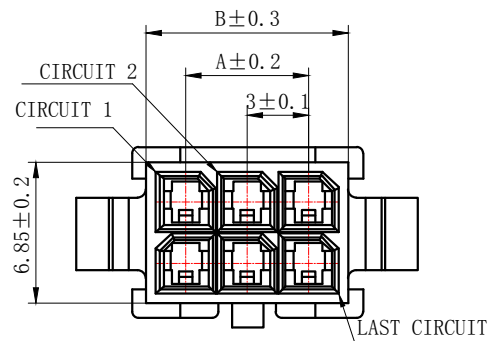

安装尺寸

Circuits	TYPE	Dimension mm			
		A	B	C	D
2X1	43020-2R	-	3.90	4.21	7.90
2X2	43020-4R	3.00	6.90	7.21	10.90
2X3	43020-6R	6.00	9.90	10.21	13.90
2X4	43020-8R	9.00	12.90	13.21	16.90
2X5	43020-10R	12.00	15.90	16.21	19.90
2X6	43020-12R	15.00	18.90	19.21	22.90
2X7	43020-14R	18.00	21.90	22.21	25.90
2X8	43020-16R	21.00	24.90	25.21	28.90
2X9	43020-18R	24.00	27.90	28.21	31.90
2X10	43020-20R	27.00	30.90	31.21	34.90
2X11	43020-22R	30.00	33.90	34.21	37.90
2X12	43020-24R	33.00	36.90	37.21	40.90

GENERAL TOLERANCES (UNLESS SPECIFIED)		ZHE JIANG DELI CONNECTORS CO., LTD	
.X: ± 0.25	X°: ± 3.0°	PRODUCT NAME: DL30001 (43020)-R	TITLE: 3.0mm Pitch Wire To Wire Plug Housing
.XX: ± 0.15	.X°: ± 2.0°	DR:Chen Quan Long	DATE:20/08/01
.XXX: ± 0.01	.XX°: ± 1.0°	DATE:20/08/01	PART NO:
FINISH:		CHKD: Wu Hui	DATE:20/08/01
DRAWING NO:		APPD:Ren An De	DATE:20/08/01
		SCALE: N/A	PAGE: 1/2
		UNITS: mm	REV.: A



REV.	REVISION DESCRIPTION	DATE	APPD



**NOTES**

Available in 02 through 24 Circuits.  
 Mates with DL30001-Y Series Housing.  
 Material : Nylon UL94V-0 (2) .  
 Accepts DL30001-RT Crimp Terminal.



Circuits	TYPE	Dimension mm	
		A	B
2X1	43020-2RF	-	3.90
2X2	43020-4RF	3.00	6.90
2X3	43020-6RF	6.00	9.90
2X4	43020-8RF	9.00	12.90
2X5	43020-10RF	12.00	15.90
2X6	43020-12RF	15.00	18.90
2X7	43020-14RF	18.00	21.90
2X8	43020-16RF	21.00	24.90
2X9	43020-18RF	24.00	27.90
2X10	43020-20RF	27.00	30.90
2X11	43020-22RF	30.00	33.90
2X12	43020-24RF	33.00	36.90

GENERAL TOLERANCES (UNLESS SPECIFIED)		ZHE JIANG DELI CONNECTORS CO., LTD	
.X: ± 0.25	X°: ± 3.0°	PRODUCT NAME: DL30001 (43020)-RF	TITLE: 3.0mm Pitch Wire To Wire Plug Housing
.XX: ± 0.15	.X°: ± 2.0°	DR: Yuan Jun Rong	DATE: 20/08/01
.XXX: ± 0.01	.XX°: ± 1.0°	DATE: 20/08/01	PART NO:
FINISH:		CHKD: Wu Hui	DATE: 20/08/01
DRAWING NO:		APPD: Ren An De	DATE: 20/08/01
		SCALE: N/A	PAGE: 1/2
		UNITS: mm	REV.: A

REV.	REVISION DESCRIPTION	DATE	APPD



### NOTES

Used in DL30001-Y Series Housing.  
 Accepts AWG #28~20 Wire Range.  
 Material : Phosphor Bronze .  
 Finish: Tin plated.  
 Thickness: 0.2 mm.  
 Green Material RoHS Compliant.

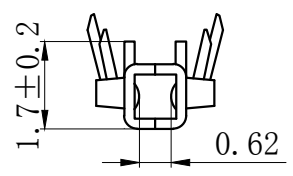
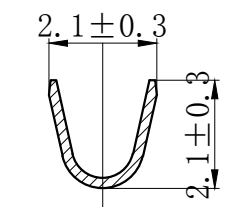

SECTION A-A

SECTION B-B

SECTION C-C

GENERAL TOLERANCES (UNLESS SPECIFIED)		ZHE JIANG DELI CONNECTORS CO., LTD	
.X: $\pm 0.25$	X°: $\pm 3.0^\circ$	PRODUCT NAME: DL30001 (43030)-T	TITLE: 3.0mm Pitch Wire To Board Crimp Terminal
.XX: $\pm 0.15$	.X°: $\pm 2.0^\circ$	DR: Chen Quan Long	DATE: 20.03.11
.XXX: $\pm 0.01$	.XX°: $\pm 1.0^\circ$	CHKD: Wu Hui	DATE: 20.03.11
DRAWING NO:		APPD: Ren An De	DATE: 20.03.11
		SCALE: N/A	PAGE: 1/1
		UNITS: mm	REV.: A

REV.	REVISION DESCRIPTION	DATE	APPD



### NOTES

Used in DL30001-R Series Housing.  
 Accepts AWG #28~20 Wire Range.  
 Material : Phosphor Bronze .  
 Finish: Tin plated.  
 Thickness: 0.2 mm.  
 Green Material RoHS Compliant.

头部抱紧严实

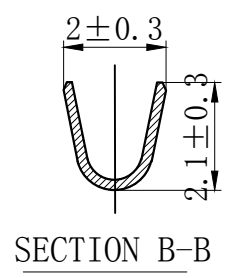
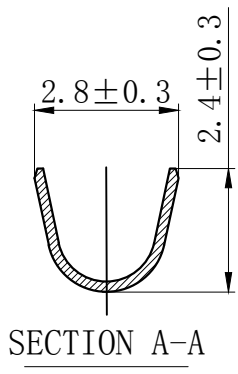

GENERAL TOLERANCES (UNLESS SPECIFIED)		ZHE JIANG DELI CONNECTORS CO., LTD	
.X: $\pm 0.25$	X°: $\pm 3.0^\circ$	PRODUCT NAME: DL30001(43031)-RT	TITLE: 3.0mm Pitch Wire To Wire Crimp Terminal
.XX: $\pm 0.15$	.X°: $\pm 2.0^\circ$	DR:Chen Quan Long	DATE:20.03.11
.XXX: $\pm 0.01$	.XX°: $\pm 1.0^\circ$	CHKD: Wu Hui	DATE:20.03.11
DRAWING NO:		APPD:Ren An De	DATE:20.03.11
		SCALE: N/A	PAGE: 1/1
		UNITS: mm	REV.: A

## X-ON Electronics

Largest Supplier of Electrical and Electronic Components

*Click to view similar products for [Headers & Wire Housings](#) category:*

*Click to view products by [DLL](#) manufacturer:*

Other Similar products are found below :

[0015917161](#) [0022155065](#) [57102-F02-18ULF](#) [58102-G61-06LF](#) [582553-1](#) [01.001.5753.1](#) [0050291907](#) [02.125.8002.8](#) [609-3404](#) [61062-3](#)  
[CSU011177004](#) [622-0430](#) [622-3653LF](#) [63453-116](#) [636-1030](#) [636-1427](#) [636-3427](#) [636-4007](#) [641938-9](#) [65495-038](#) [65692-001LF](#) [65781-018](#)  
[65781-047](#) [65817-010LF](#) [65817-015LF](#) [67095-007LF](#) [67601157](#) [68631-112](#) [68645-018](#) [699319-000](#) [70.362.1628.0](#) [70-4210](#) [70-4226B](#) [70-](#)  
[4853B](#) [71.350.2428.0](#) [733-134](#) [733-162](#) [760-3052](#) [MHR-64-VUAL](#) [80.063.4001.1](#) [800-90-001-10-001000](#) [801-43-002-10-013000](#)  
[801-43-006-10-002000](#) [803-43-024-10-001000](#) [803-93-012-10-001000](#) [8-1437020-4](#) [819-22-004-30-001101](#) [820-22-006-30-001101](#)  
[820-22-008-30-001101](#) [821-22-002-10-001101](#)