

技术特性/Specifications:

额定电压 Rated voltage: 250V AC, DC
额定电流 Rated current: 3.5A AC, DC
接触电阻 Contact resistance: 20m Ω max
绝缘电阻 Insulation resistance: 1000M Ω min
耐压 Withstand voltage: 1000V AC/minute
环境温度 Ambient temperature: -40 $^{\circ}$ C~+105 $^{\circ}$ C
适用线规 Wire range: AWG#28~#20

REV.	REVISION DESCRIPTION	DATE	APPD

NOTES

Available in 02 through 12 Circuits.
 Mates with DL30004-Y Series Housing.
 Material : LCP UL94V-0.
 Pin Material : Brass.Matte-plated .

ORDERING INFORMATION

DL30004 - XX B - X XX - X X - X - XX
 1 2 3 4 5 6 7 8 9

- PART NO.
- NO. OF CIRCUIT
- CONN. TYPE
- MATERIAL: 0:PA66 V0 1:PA66 V1 2:PA66 V2 3:PA66 V0 750 °C
 4:LCP 5:PBT 6:PA9T 7:9A6T 8: GF PA66
- COLOR: NA:NATURE RE:RED BR:BROWN
 GY:GREY BK:BLACK YE:YELLOW
 BL:BLUE GR:GREEN PU:PURPLE PI:PINK
 OR:ORANGE TR:TRANSPARENT OT:OTHER
- CONTACT MATERIAL: P:PHOSPHOR BRONZE B:BRASS
- FINISH: T:TIN MT:MATT TIN BG/QG:GOLD S:SILVER
- STYLE: Z:WITHOUT K K:WITH K
- SERIAL NUMBER: 00.01.02.....

3	③	基座	LCP	1	UL94V-0
2	②	焊片	黄铜	2	镀亚光
1	①	接触件	黄铜	N*	镀亚光
序号	图号	名称	材料	数量	附件

GENERAL TOLERANCES (UNLESS SPECIFIED)		ZHE JIANG DELI CONNECTORS CO.,LTD			
.X: ± 0.25	X°: ± 3.0°	PRODUCT NAME: DL30004-AB(43650-AB)		TITLE: 3.0 mm Pitch Wire To Board SMT Wafer	
.XX: ± 0.15	.X°: ± 2.0°	DR:Yuan Jun Rong		DATE:20/07/27	
.XXX: ± 0.01	.XX°: ± 1.0°	CHKD:Wu Hui		DATE:20/07/27	
DRAWING NO: GC=DL30001-XXB-XXX-XX-X-XX		APPD:Ren An De		DATE:20/07/27	
		SCALE: N/A		PAGE: 1/1	
		UNITS: mm		REV.: A	

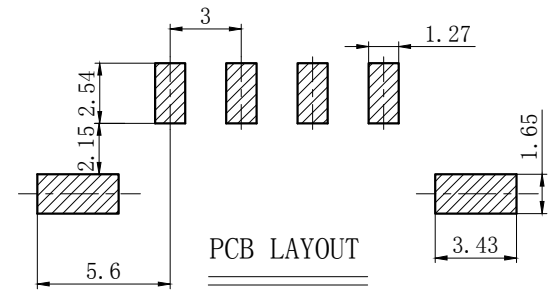
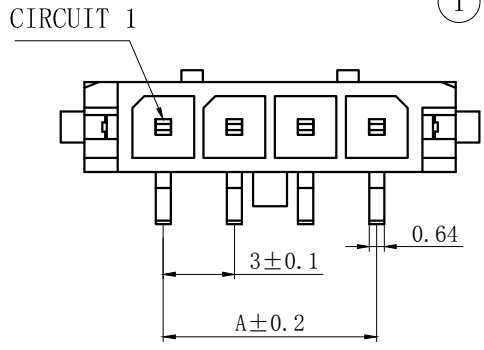
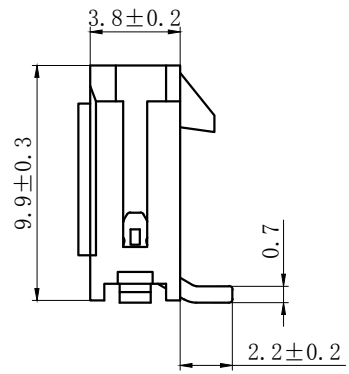
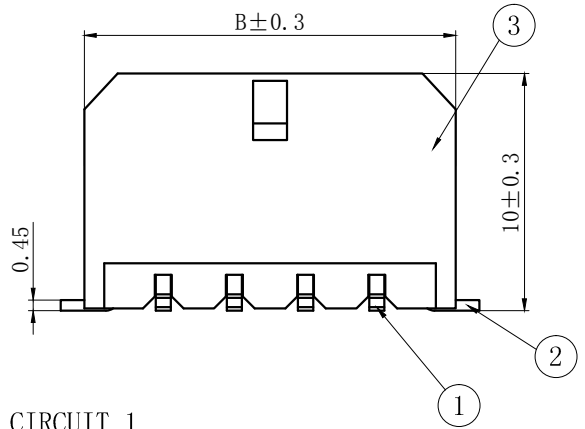
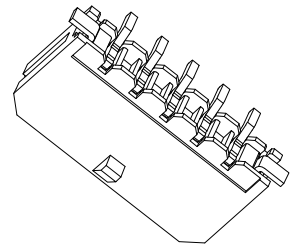
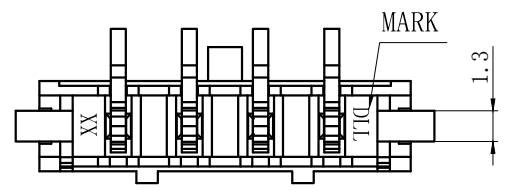

孔位 poles	TYPE	A	B	孔位 poles	TYPE	A	B
—	—	—	—	7	43650-7AB	18.0	24.6
2	43650-2AB	3.0	9.6	8	43650-8AB	21.0	27.6
3	43650-3AB	6.0	12.6	9	43650-9AB	24.0	30.6
4	43650-4AB	9.0	15.6	10	43650-10AB	27.0	33.6
5	43650-5AB	12.0	18.6	11	43650-11AB	30.0	36.6
6	43650-6AB	15.0	21.6	12	43650-12AB	33.0	39.6

REV.	REVISION DESCRIPTION	DATE	APPD

NOTES

Available in 02 through 12 Circuits.
 Mates with DL30004-Y Series Housing.
 Material : LCP UL94V-0.
 Pin Material : Brass.Matte-plated .

ORDERING INFORMATION

DL30004 - XX WB - X XX - X X - X - XX
 1 2 3 4 5 6 7 8 9

- PART NO.
- .NO. OF CIRCUIT
- CONN. TYPE
- MATERIAL: 0:PA66 V0 1:PA66 V1 2:PA66 V2 3:PA66 V0 750 °C
 4:LCP 5:PBT 6:PA9T 7:9A6T 8: GF PA66
- COLOR: NA:NATURE RE:RED BR:BROWN
 GY:GREY BK:BLACK YE:YELLOW
 BL:BLUE GR:GREEN PU:PURPLE PI:PINK
 OR:ORANGE TR:TRANSPARENT OT:OTHER
- CONTACT MATERIAL: P:PHOSPHOR BRONZE B:BRASS
- FINISH: T:TIN MT:MATT TIN BG/QG:GOLD S:SILVER
- STYLE: Z:WITHOUT K K:WITH K
- SERIAL NUMBER: 00.01.02.....

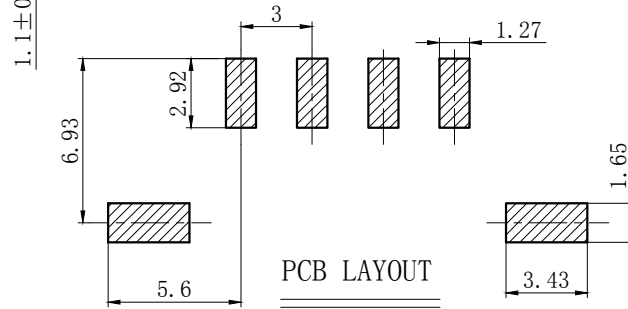
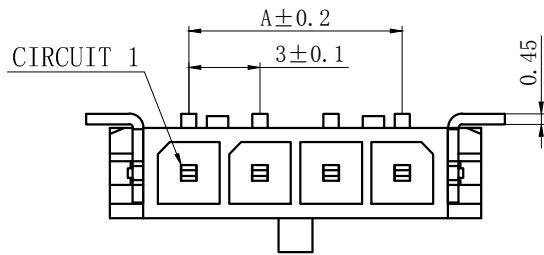
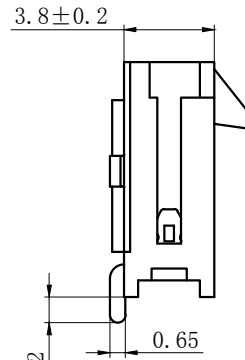
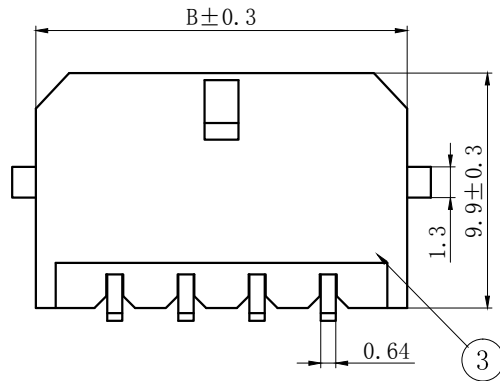
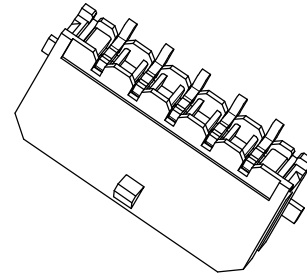
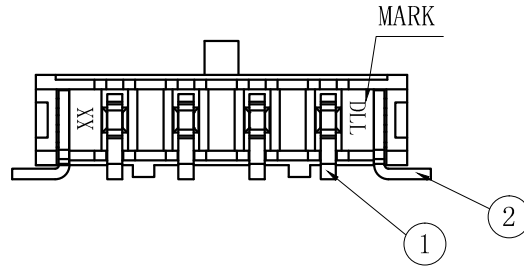

3	③	基座	LCP	1	UL94V-0
2	②	焊片	黄铜	2	镀亚光
1	①	接触件	黄铜	N*	镀亚光
序号	图号	名称	材料	数量	附件

孔位 poles	TYPE	A	B	孔位 poles	TYPE	A	B
—	—	—	—	7	43650-7AWB	18.0	24.6
2	43650-2AWB	3.0	9.6	8	43650-8AWB	21.0	27.6
3	43650-3AWB	6.0	12.6	9	43650-9AWB	24.0	30.6
4	43650-4AWB	9.0	15.6	10	43650-10AWB	27.0	33.6
5	43650-5AWB	12.0	18.6	11	43650-11AWB	30.0	36.6
6	43650-6AWB	15.0	21.6	12	43650-12AWB	33.0	39.6

GENERAL TOLERANCES (UNLESS SPECIFIED)		ZHE JIANG DELI CONNECTORS CO., LTD	
.X: ± 0.25	X°: ± 3.0°	PRODUCT NAME:	TITLE: 3.0 mm Pitch
.XX: ± 0.15	.X°: ± 2.0°	DL30004-AWB(43650-AWB)	Wire To Board SMT Wafer
.XXX: ± 0.01	.XX°: ± 1.0°	DR:Yuan Jun Rong	DATE:20/07/27
FINISH:		CHKD:Wu Hui	DATE:20/07/27
DRAWING NO: GC-DL30004-XXWB-XXX-XX-X-XX		APPD:Ren An De	DATE:20/07/27
		SCALE: N/A	PAGE: 1/1
		UNITS: mm	REV.: A

REV.	REVISION DESCRIPTION	DATE

NOTES:

- 1、Rated voltage : 250V AC.DC
- 2、Rated current : 3.5A AC.DC
- 3、Contact resistance : $\leq 20m\Omega$
- 4、Insulation resistance : $\geq 1000M\Omega$
- 5、Withstand voltage : 1000V AC/minute
- 6、Ambient temperature : $-40^{\circ}C \sim 105^{\circ}C$
- 7、Materials : Nylon UL94V-0(2)
- 8、Green Material RoHS Compliant

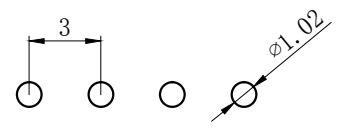
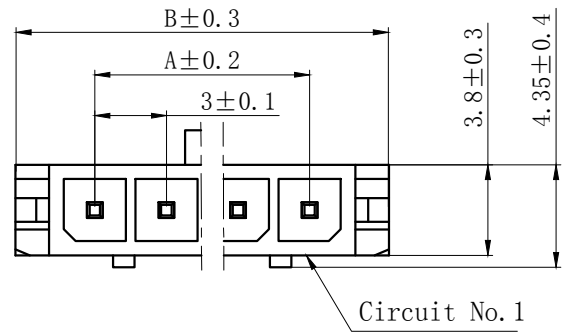
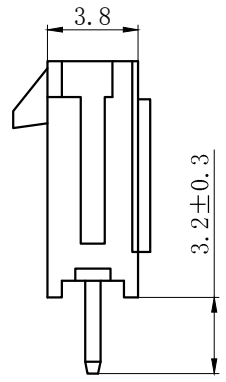
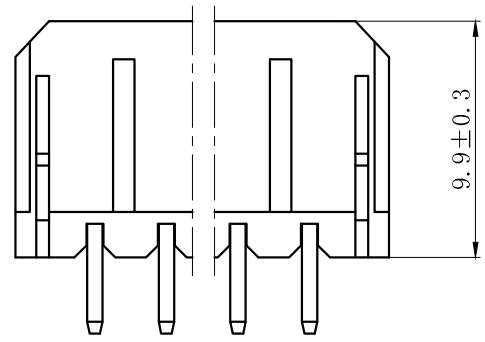

PCB LAYOUT

ORDERING INFORMATION

DL 30004 - XX A - X XX - X X - X - XX
 1 2 3 4 5 6 7 8 9

1. PART NO.
2. NO. OF CIRCUIT
3. CONN. TYPE
4. MATERIAL: 0: PA66 V0 1: PA66 V1 2: PA66 V2
 3: PA66 V0 750°C 4: LCP 5: PBT 6: PA9T
5. COLOR: NA:NATURE RE:RED BR:BROWN
 GY:GREY BK:BLACK YE:YELLOW
 BL:BLUE GR:GREEN PU:PURPLE PI:PINK
 OR:ORANGE TR:TRANSPARENT OT:OTHER
6. CONTACT MATERIAL: P:PHOSPHOR BRONZE B:BRASS
7. FINISH: T:TIN MT:MATT TIN BG/QG:GOLD S:SILVER
8. STYLE: Z:WITHOUT K K:WITH K
9. SERIAL NUMBER: 00.01.02.....

Circuits	Dimension mm	
	A	B
2	3.0	9.6
3	6.0	12.6
4	9.0	15.6
5	12.0	18.6
6	15.0	21.6
7	18.0	24.6
8	21.0	27.6
9	24.0	30.6
10	27.0	33.6
11	30.0	36.6
12	33.0	39.6

GENERAL TOLERANCES (UNLESS SPECIFIED)		ZHE JIANG DELI CONNECTORS CO., LTD	
.X: ± 0.25	X°: ± 3.0°	PRODUCT NAME: DL30004-A(43650-A)	TITLE: 3.0 mm Pitch Wire To Board Wafer
.XX: ± 0.15	.X°: ± 2.0°	DR:Chen Quan Long	DATE:20/04/03
.XXX: ± 0.01	.XX°: ± 1.0°	CHKD: Wu Hui	DATE:20/04/03
FINISH: _____		APPD:Ren An De	DATE:20/04/03
DRAWING NO: GC-DL30004-XXA-XXX-XX-X-XX		PART NO: DL30004-XXA-XXX-XX-X-XX	
		SCALE: N/A	PAGE: 1/1
		UNITS: mm	REV.: A

REV.	REVISION	DATE
	DESCRIPTION	

NOTES:

- 1、Rated voltage : 250V AC.DC
- 2、Rated current : 3.5A AC.DC
- 3、Contact resistance : $\leq 20m\Omega$
- 4、Insulation resistance : $\geq 1000M\Omega$
- 5、Withstand voltage : 1000V AC/minute
- 6、Ambient temperature : $-40^{\circ}C \sim 105^{\circ}C$
- 7、Materials : Nylon UL94V-0(2)
- 8、Green Material RoHS Compliant

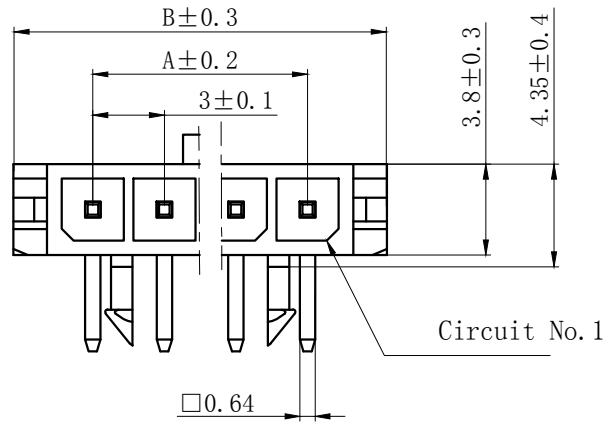
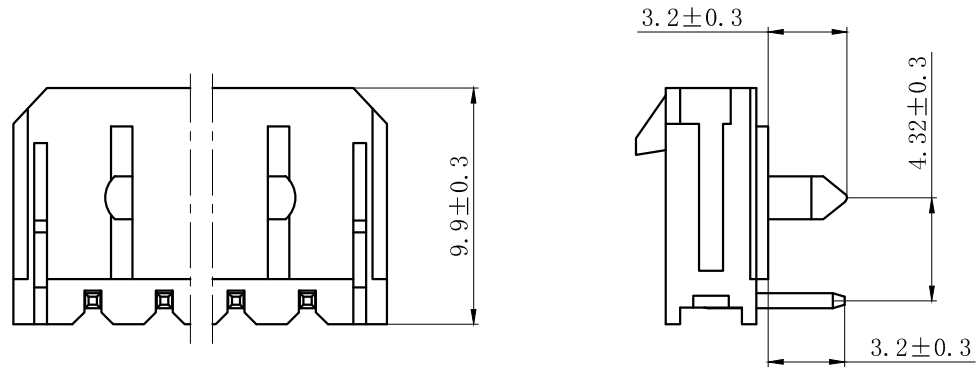

ORDERING INFORMATION

DL 30004 - XX WS - X XX - X X - X - XX
 1 2 3 4 5 6 7 8 9

1. PART NO.
2. NO. OF CIRCUIT
3. CONN. TYPE
4. MATERIAL: 0: PA66 V0 1: PA66 V1 2: PA66 V2
3: PA66 V0 750°C 4: LCP 5: PBT 6: PA9T
5. COLOR: NA:NATURE RE:RED BR:BROWN
GY:GREY BK:BLACK YE:YELLOW
BL:BLUE GR:GREEN PU:PURPLE PI:PINK
OR:ORANGE TR:TRANSPARENT OT:OTHER
6. CONTACT MATERIAL: P:PHOSPHOR BRONZE B:BRASS
7. FINISH: T:TIN MT:MATT TIN BG/QG:GOLD S:SILVER
8. STYLE: Z:WITHOUT K K:WITH K
9. SERIAL NUMBER: 00.01.02.....

Circuits	Dimension mm		
	A	B	C
2	3.0	9.6	0
3	6.0	12.6	0
4	9.0	15.6	4.7
5	12.0	18.6	7.7
6	15.0	21.6	10.7
7	18.0	24.6	13.7
8	21.0	27.6	16.7
9	24.0	30.6	19.7
10	27.0	33.6	22.7
11	30.0	36.6	25.7
12	33.0	39.6	28.7

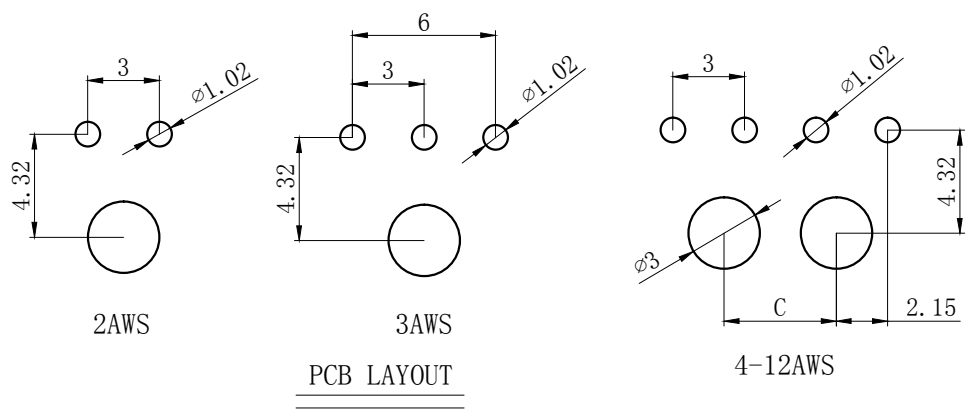

GENERAL TOLERANCES (UNLESS SPECIFIED)		ZHE JIANG DELI CONNECTORS CO.,LTD	
.X: ± 0.25	X°: ± 3.0°	PRODUCT NAME:	TITLE: 3.0 mm Pitch Wire To Board Wafer
.XX: ± 0.15	.X°: ± 2.0°	DL30004-AWS(43650-AWS)	
.XXX: ± 0.01	.XX°: ± 1.0°	DR:Chen Quan Long	DATE:20/04/03
FINISH:		CHKD: Wu Hui	DATE:20/04/03
DRAWING NO:		APPD:Ren An De	DATE:20/04/03
GC-DL30004-XXWS-XXX-XX-X-XX			PART NO: DL30004-XXWS-XXX-XX-X-XX
			SCALE: N/A PAGE: 1/1
			UNITS: mm REV.: A

REV.	REVISION DESCRIPTION	DATE	APPD

3PIN~12PIN

2PIN

NOTES:

- 1、Rated voltage : 250V AC.DC
- 2、Rated current : 3.5A AC.DC
- 3、Contact resistance : $\leq 20m\Omega$
- 4、Insulation resistance : $\geq 1000M\Omega$
- 5、Withstand voltage : 1000V AC/minute
- 6、Ambient temperature : $-40^{\circ}C \sim 105^{\circ}C$
- 7、Materials : Nylon UL94V-0(2)
- 8、Green Material RoHS Compliant

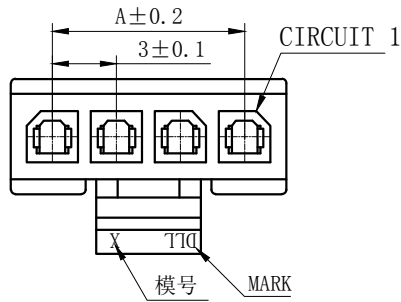
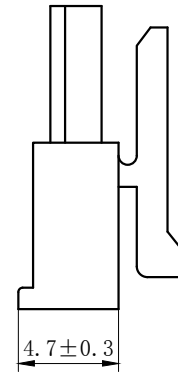
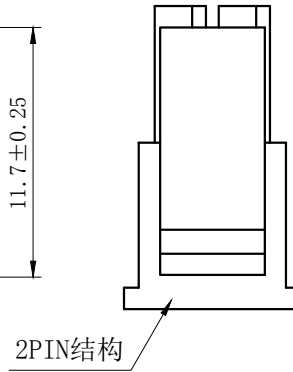
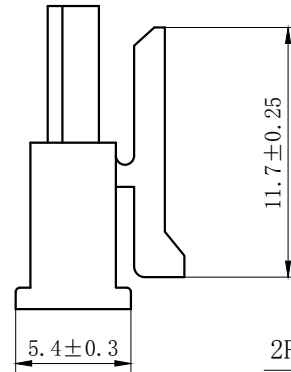
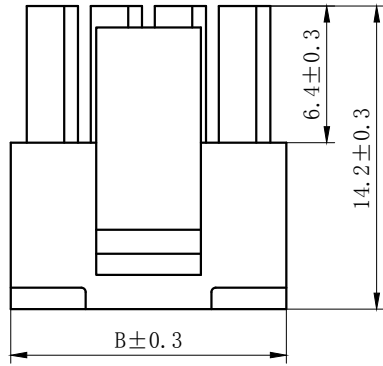

ORDERING INFORMATION

DL 30004 - XX Y - X XX - XX
 1 2 3 4 5 6

1. PART NO.
2. . NO. OF CIRCUIT
3. CONN. TYPE
4. MATERIAL: 0:PA66 V0 1:PA66 V1 2:PA66 V2
 3:PA66 V0 750 °C 4:LCP 5:PBT
 6:PA9T 7:9A6T 8:GF PA66
5. COLOR: NA:NATURE RE:RED BR:BROWN
 GY:GREY BK:BLACK YE:YELLOW
 BL:BLUE GR:GREEN PU:PURPLE PI:PINK
 OR:ORANGE TR:TRANSPARENT OT:OTHER
6. SERIAL NUMBER: 00.01.02.....

Circuits	Type	Dimension mm		Circuits	Type	Dimension mm	
		A	B			A	B
2	43645-2Y	3.0	6.9	8	43645-8Y	21.0	24.9
3	43645-3Y	6.0	9.9	9	43645-9Y	24.0	27.9
4	43645-4Y	9.0	12.9	10	43645-10Y	27.0	30.9
5	43645-5Y	12.0	15.9	11	43645-11Y	30.0	33.9
6	43645-6Y	15.0	18.9	12	43645-12Y	33.0	36.9
7	43645-7Y	18.0	21.9				

GENERAL TOLERANCES (UNLESS SPECIFIED)		ZHE JIANG DELI CONNECTORS CO., LTD	
.X: ± 0.25	X°: ± 3.0°	PRODUCT NAME: DL30004-Y (43645-Y)	TITLE: 3.0mm Pitch Housing
.XX: ± 0.15	.X°: ± 2.0°	DR: Chen Quan Long	DATE:20/08/01
.XXX: ± 0.01	.XX°: ± 1.0°	DATE:20/08/01	PART NO: DL30004-XXY-XXX-XX
FINISH:		CHKD:Wu Hui	DATE:20/08/01
DRAWING NO: GC-DL30004-XXY-XXX-XX		APPD:Ren An De	DATE:20/08/01
		SCALE: N/A	PAGE: 1/1
		UNITS: mm	REV.: A

REV.	REVISION DESCRIPTION	DATE	APPD

NOTES:

- 1、Rated voltage : 250V AC.DC
- 2、Rated current : 3.5A AC.DC
- 3、Contact resistance : $\leq 20m\Omega$
- 4、Insulation resistance : $\geq 1000M\Omega$
- 5、Withstand voltage : 1000V AC/minute
- 6、Ambient temperature : $-40^{\circ}C \sim 105^{\circ}C$
- 7、Materials : Nylon UL94V-0(2)
- 8、Green Material RoHS Compliant

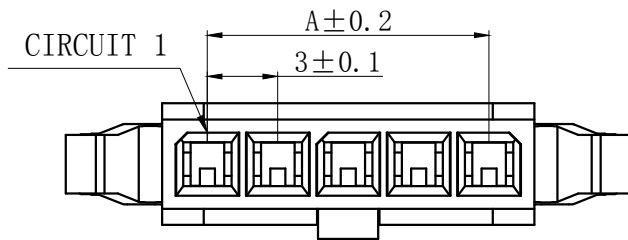
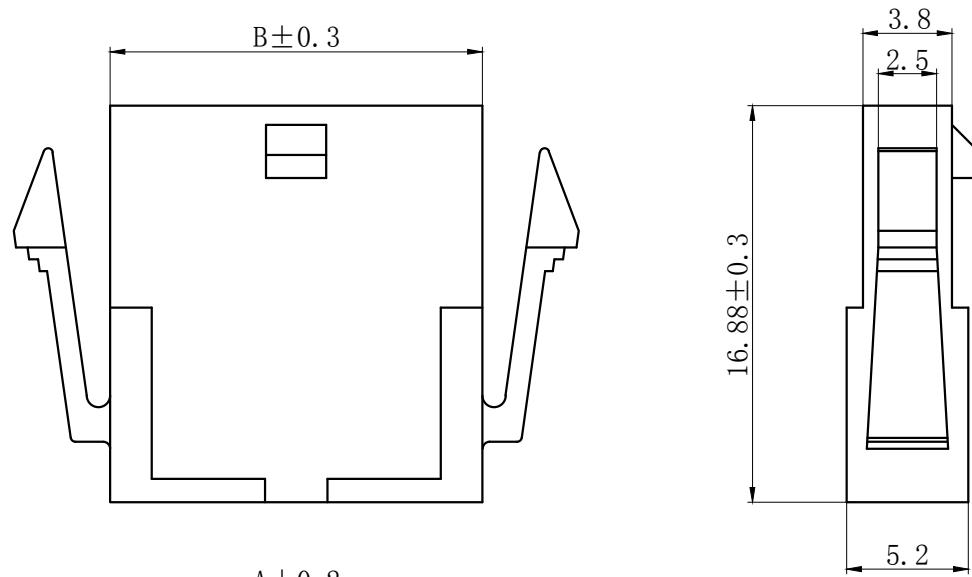

ORDERING INFORMATION

DL30004 - XX R - X XX - XX
 1 2 3 4 5 6

1. PART NO.
2. NO. OF CIRCUIT
3. CONN. TYPE
4. MATERIAL: 0:PA66 V0 1:PA66 V1 2:PA66 V2
 3:PA66 V0 750°C 4:LCP 5:PBT
 6:PA9T 7:PA6T 8:GF PA66
5. COLOR: NA:NATURE RE:RED BR:BROWN
 GY:GREY BK:BLACK YE:YELLOW
 BL:BLUE GR:GREEN PU:PURPLE PI:PINK
 OR:ORANGE TR:TRANSPARENT OT:OTHER
6. SERIAL NUMBER: 00.01.02.....

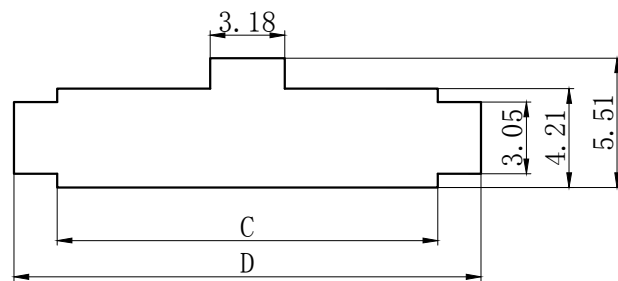

安装尺寸

Circuits	Type	Dimension mm			
		A	B	C	D
2	43640-2R	3.00	6.90	7.21	10.90
3	43640-3R	6.00	9.90	10.21	13.90
4	43640-4R	9.00	12.90	13.21	16.90
5	43640-5R	12.00	15.90	16.21	19.90
6	43640-6R	15.00	18.90	19.21	22.90
7	43640-7R	18.00	21.90	22.21	25.90
8	43640-8R	21.00	24.90	25.21	28.90
9	43640-9R	24.00	27.90	28.21	31.90
10	43640-10R	27.00	30.90	31.21	34.90
11	43640-11R	30.00	33.90	34.21	37.90
12	43640-12R	33.00	36.90	37.21	40.90

GENERAL TOLERANCES (UNLESS SPECIFIED)		ZHE JIANG DELI CONNECTORS CO., LTD	
.X: ± 0.25	X°: ± 3.0°	PRODUCT NAME: DL30004-R(43640-R)	TITLE: 3.0mm Pitch Wire To Wire Housing
.XX: ± 0.15	.X°: ± 2.0°	DR: Yuan Jun Rong	DATE:21/08/01
.XXX: ± 0.01	.XX°: ± 1.0°	DATE:21/08/01	PART NO: DL30004-XXR-XXX-XX
FINISH:		CHKD:Wu Hui	DATE:21/08/01
DRAWING NO: GC-DL30004-XXR-XXX-XX		APPD:Ren An De	DATE:21/08/01
			SCALE: N/A
			PAGE: 1/2
			UNITS: mm
			REV.: A

REV.	REVISION DESCRIPTION	DATE	APPD

NOTES:

- 1、Rated voltage : 250V AC.DC
- 2、Rated current : 3.5A AC.DC
- 3、Contact resistance : $\leq 20m\Omega$
- 4、Insulation resistance : $\geq 1000M\Omega$
- 5、Withstand voltage : 1000V AC/minute
- 6、Ambient temperature : $-40^{\circ}C \sim 105^{\circ}C$
- 7、Materials : Nylon UL94V-0(2)
- 8、Green Material RoHS Compliant

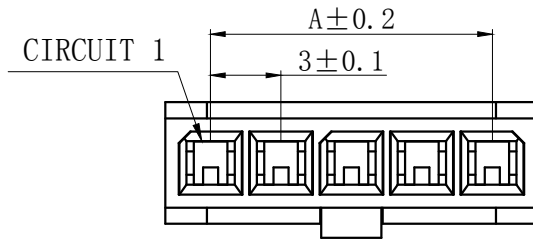
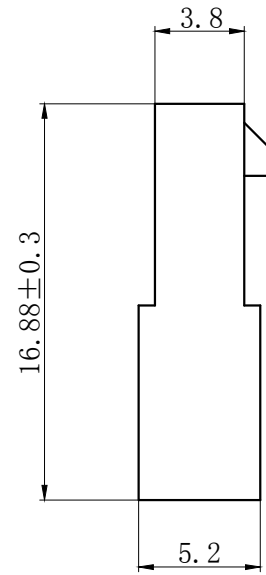
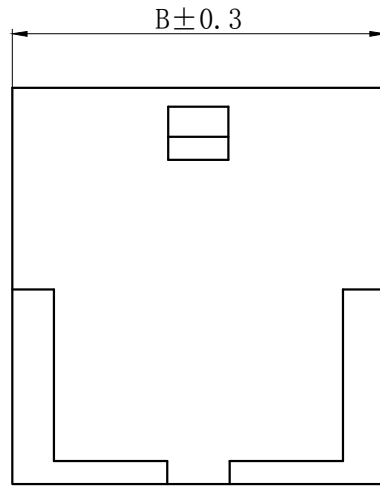

ORDERING INFORMATION

DL30004 - XX RF - X XX - XX
 1 2 3 4 5 6

1. PART NO.
2. NO. OF CIRCUIT
3. CONN. TYPE
4. MATERIAL: 0:PA66 V0 1:PA66 V1 2:PA66 V2
 3:PA66 V0 750 °C 4:LCP 5:PBT
 6:PA9T 7:9A6T 8:GF PA66
5. COLOR: NA:NATURE RE:RED BR:BROWN
 GY:GREY BK:BLACK YE:YELLOW
 BL:BLUE GR:GREEN PU:PURPLE PI:PINK
 OR:ORANGE TR:TRANSPARENT OT:OTHER
6. SERIAL NUMBER: 00.01.02.....

Circuits	Type	Dimension mm		Circuits	Type	Dimension mm	
		A	B			A	B
2	43640-2RF	3.0	6.9	8	43640-8RF	21.0	24.9
3	43640-3RF	6.0	9.9	9	43640-9RF	24.0	27.9
4	43640-4RF	9.0	12.9	10	43640-10RF	27.0	30.9
5	43640-5RF	12.0	15.9	11	43640-11RF	30.0	33.9
6	43640-6RF	15.0	18.9	12	43640-12RF	33.0	36.9
7	43640-7RF	18.0	21.9				

GENERAL TOLERANCES (UNLESS SPECIFIED)		ZHE JIANG DELI CONNECTORS CO., LTD	
.X: ± 0.25	X°: ± 3.0°	PRODUCT NAME: DL30004-RF(43640-RF)	TITLE: 3.0mm Pitch Wire To Wire Housing
.XX: ± 0.15	.X°: ± 2.0°	DR: Yuan Jun Rong	DATE:21/08/01
.XXX: ± 0.01	.XX°: ± 1.0°	CHKD:Wu Hui	DATE:21/08/01
FINISH:		APPD:Ren An De	DATE:21/08/01
DRAWING NO: GC-DL30004-XXRF-XXX-XX			
			PART NO: DL30004-XXRF-XXX-XX
			SCALE: N/A
			PAGE: 1/2
			UNITS: mm
			REV.: A

REV.	REVISION DESCRIPTION	DATE	APPD

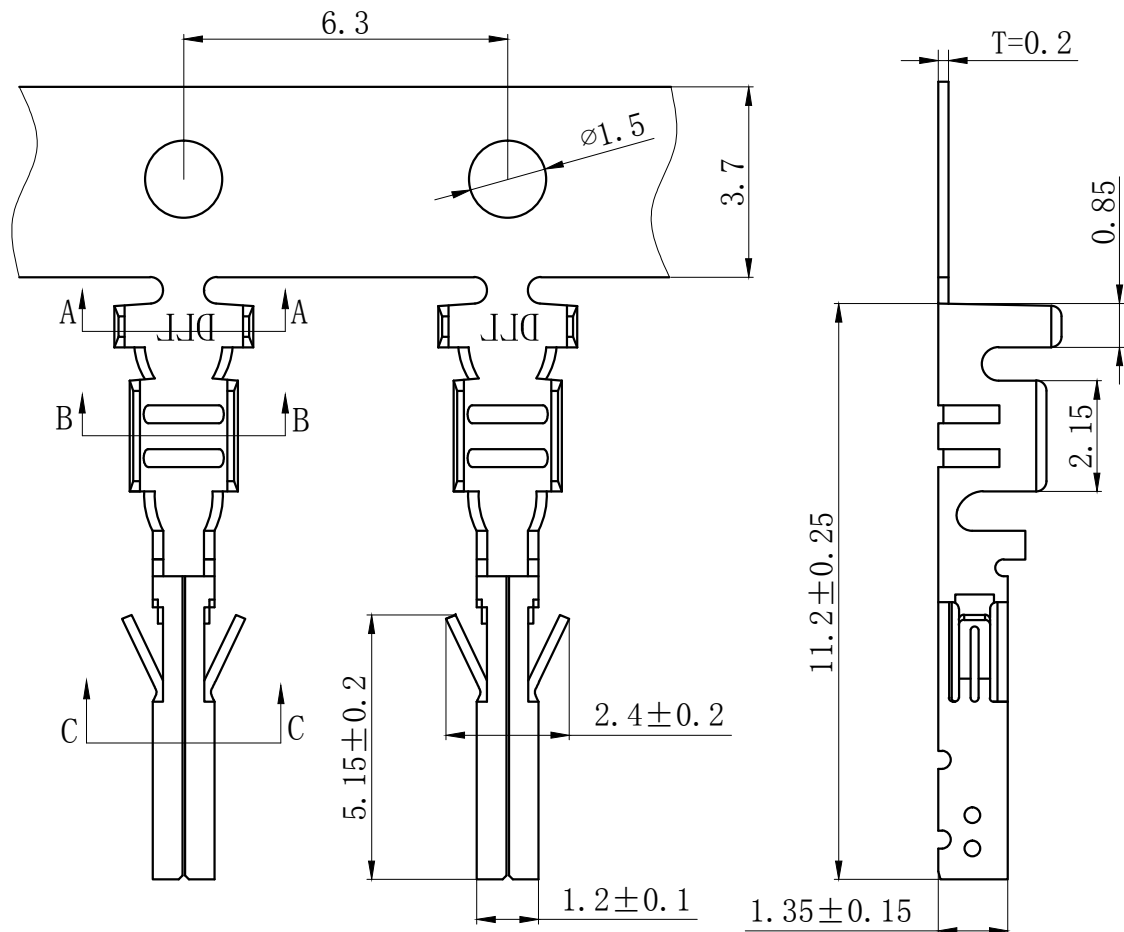

NOTES

Used in DL30001-Y Series Housing.
 Accepts AWG #28~20 Wire Range.
 Material : Phosphor Bronze .
 Finish: Tin plated.
 Qty/Reel: 10000 PCS.
 Thickness: 0.2 mm.
 Green Material RoHS Compliant.

ORDERING INFORMATION

DL XXXXX - XX - X - X - X - XX
 1 2 3 4 5 6

- PART NO.
- TERMINAL CODE
- MATERIAL TYPE: 1: PHOSPHOR BRONZE 2: BRASS 3: IRON
4: STAINLESS STEEL 5: OTHER
- TECHNICS: 0: UNPLATED 1: FIRST PLATING 2: POST PLATING
3: OTHER
- FINISH: 1: TIN-PLATED 2: MATTE PLATED 3: NICKEL PLATED
4: PICKLING 5: SILVER PLATED 6: GOLD PLATED
7: GALVANIZED 8: OTHER
- SERIAL NUMBER: 00.01.02.....

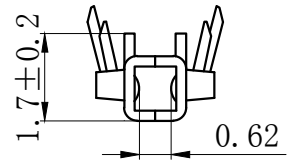
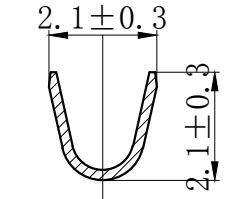
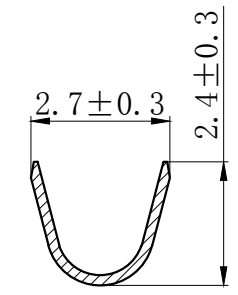

GENERAL TOLERANCES (UNLESS SPECIFIED)		ZHE JIANG DELI CONNECTORS CO., LTD	
.X: ± 0.25	.X°: $\pm 3.0^\circ$	PRODUCT NAME: DL30001-T(43030-T)	TITLE: 3.0mm Pitch Wire To Board Crimp Terminal
.XX: ± 0.15	.X°: $\pm 2.0^\circ$	DR: Chen Quan Long	DATE: 20.03.11
.XXX: ± 0.01	.XX°: $\pm 1.0^\circ$	CHKD: Wu Hui	DATE: 20.03.11
DRAWING NO: GC-DL30001-T-X-X-X-XX		APPD: Ren An De	DATE: 20.03.11
FINISH:		SCALE: N/A	PAGE: 1/1
		UNITS: mm	REV.: A

SECTION A-A

SECTION B-B

SECTION C-C

REV.	REVISION DESCRIPTION	DATE	APPD

A
B
C
D
E
F

A
B
C
D
E
F

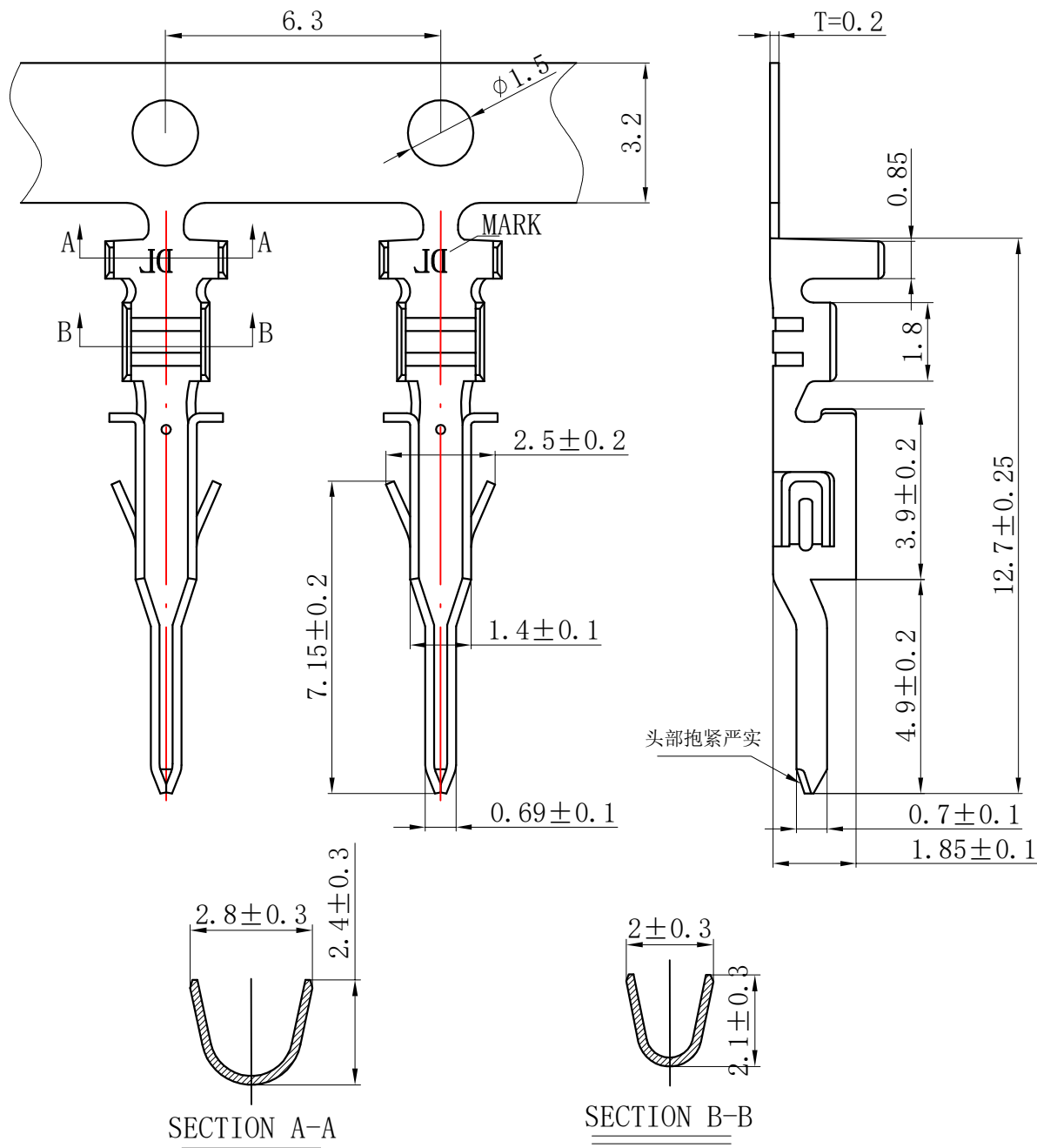

NOTES

Used in DL30001-R Series Housing.
 Accepts AWG #28~20 Wire Range.
 Material : Phosphor Bronze .
 Finish: Tin plated.
 Qty/Reel: 10000 PCS.
 Thickness: 0.2 mm.
 Green Material RoHS Compliant.

ORDERING INFORMATION

DL XXXXX - XX - X - X - X - XX
 1 2 3 4 5 6

- PART NO.
- TERMINAL CODE
- MATERIAL TYPE: 1: PHOSPHOR BRONZE 2: BRASS 3: IRON
4: STAINLESS STEEL 5: OTHER
- TECHNICS: 0: UNPLATED 1: FIRST PLATING 2: POST PLATING
3: OTHER
- FINISH: 1: TIN-PLATED 2: MATTE PLATED 3: NICKEL PLATED
4: PICKLING 5: SILVER PLATED 6: GOLD PLATED
7: GALVANIZED 8: OTHER
- SERIAL NUMBER: 00.01.02....

GENERAL TOLERANCES (UNLESS SPECIFIED)		ZHE JIANG DELI CONNECTORS CO., LTD	
.X: ± 0.25	X°: $\pm 3.0^\circ$	PRODUCT NAME: DL30001-RT (43031-RT)	TITLE: 3.0mm Pitch Wire To Wire Crimp Terminal
.XX: ± 0.15	.X°: $\pm 2.0^\circ$	DR: Chen Quan Long	DATE: 20.03.11
.XXX: ± 0.01	.XX°: $\pm 1.0^\circ$	CHKD: Wu Hui	DATE: 20.03.11
FINISH:		APPD: Ren An De	DATE: 20.03.11
DRAWING NO: GC-DL30001-RT-X-X-X-XX		SCALE: N/A	PAGE: 1/1
		UNITS: mm	REV.: A

1 2 3 4 5 6 7 8

X-ON Electronics

Largest Supplier of Electrical and Electronic Components

Click to view similar products for [Headers & Wire Housings](#) category:

Click to view products by [DLL](#) manufacturer:

Other Similar products are found below :

[0015917161](#) [0022155065](#) [57102-F02-18ULF](#) [58102-G61-06LF](#) [582553-1](#) [01.001.5753.1](#) [0050291907](#) [02.125.8002.8](#) [609-3404](#) [61062-3](#)
[CSU011177004](#) [622-0430](#) [622-3653LF](#) [63453-116](#) [636-1030](#) [636-1427](#) [636-3427](#) [636-4007](#) [641938-9](#) [65495-038](#) [65692-001LF](#) [65781-018](#)
[65781-047](#) [65817-010LF](#) [65817-015LF](#) [67095-007LF](#) [67601157](#) [68631-112](#) [68645-018](#) [699319-000](#) [70.362.1628.0](#) [70-4210](#) [70-4226B](#) [70-](#)
[4853B](#) [71.350.2428.0](#) [733-134](#) [733-162](#) [760-3052](#) [MHR-64-VUAL](#) [80.063.4001.1](#) [800-90-001-10-001000](#) [801-43-002-10-013000](#)
[801-43-006-10-002000](#) [803-43-024-10-001000](#) [803-93-012-10-001000](#) [8-1437020-4](#) [819-22-004-30-001101](#) [820-22-006-30-001101](#)
[820-22-008-30-001101](#) [821-22-002-10-001101](#)